

ZONE I
SAN JOSE AREA

Track No.	Industry
1	Passenger Track
2	Passenger Platform Track
3	Passenger Platform Track
4	Passenger Platform Track
5	Passenger Platform Track
6	Storage Commute Fleet
7	Storage Commute Fleet
8	Storage Commute Fleet
9	Storage Commute Fleet
10	Storage Commute Fleet
11	Storage Commute Fleet
101	Orchard Supply Hardware
105	Cal. Cannery & Growers #2
106	Cal. Cannery & Growers
118	A.J. Raisch Paving Co.
120	Conmat Bldg. Materials (pit)
121	Borcher Bros. (pit)
125	Lick Runaround
130	Lick Team Track
130	Valley View Packing
141	Conmat Bldg. Materials (pit)
149	Lick Branch Line
149	Alamitos Team Track (end)
149	Hubbard and Johnson (end)
150	Alamitos Team Track
186	IBM - Oak Grove
188	IBM - Oak Grove
189	IBM - Oak Grove - Runaround

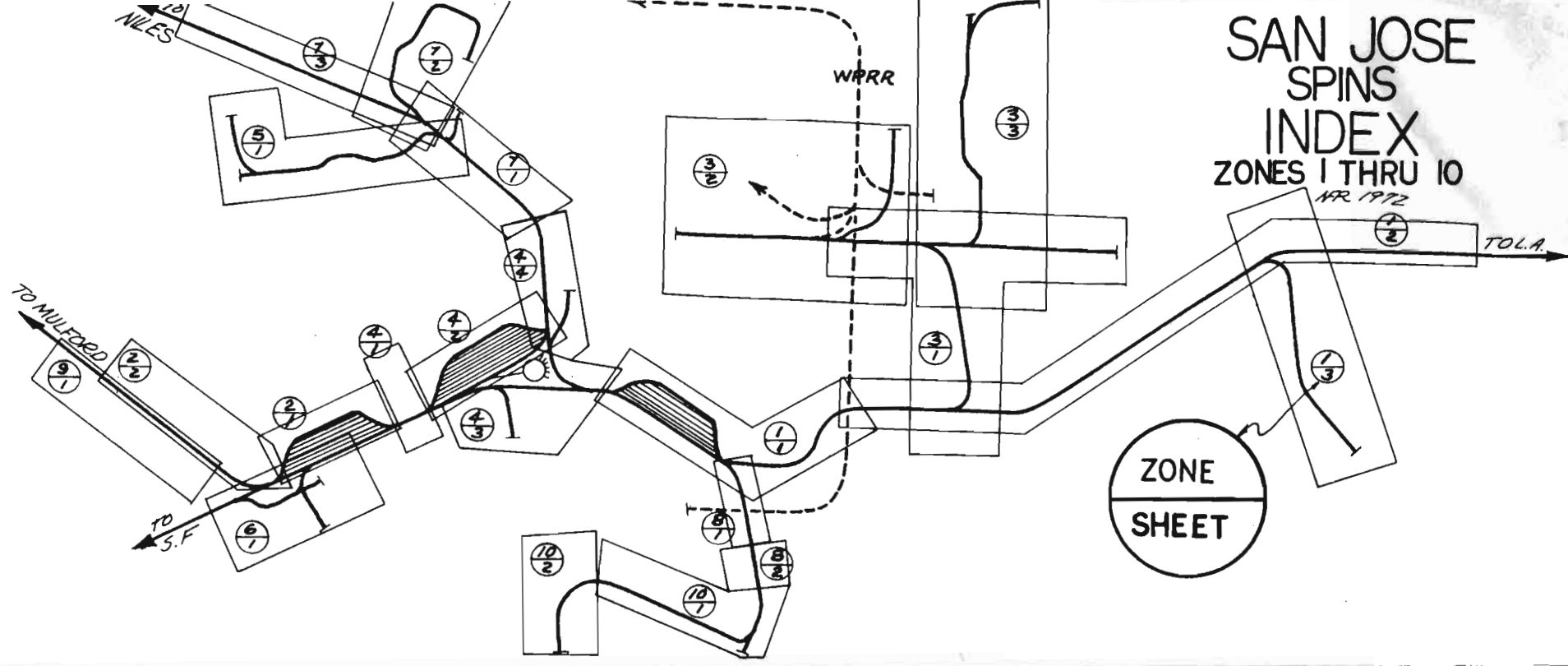

SAN JOSE
SPINS
INDEX
ZONES I THRU 10

APR 1972

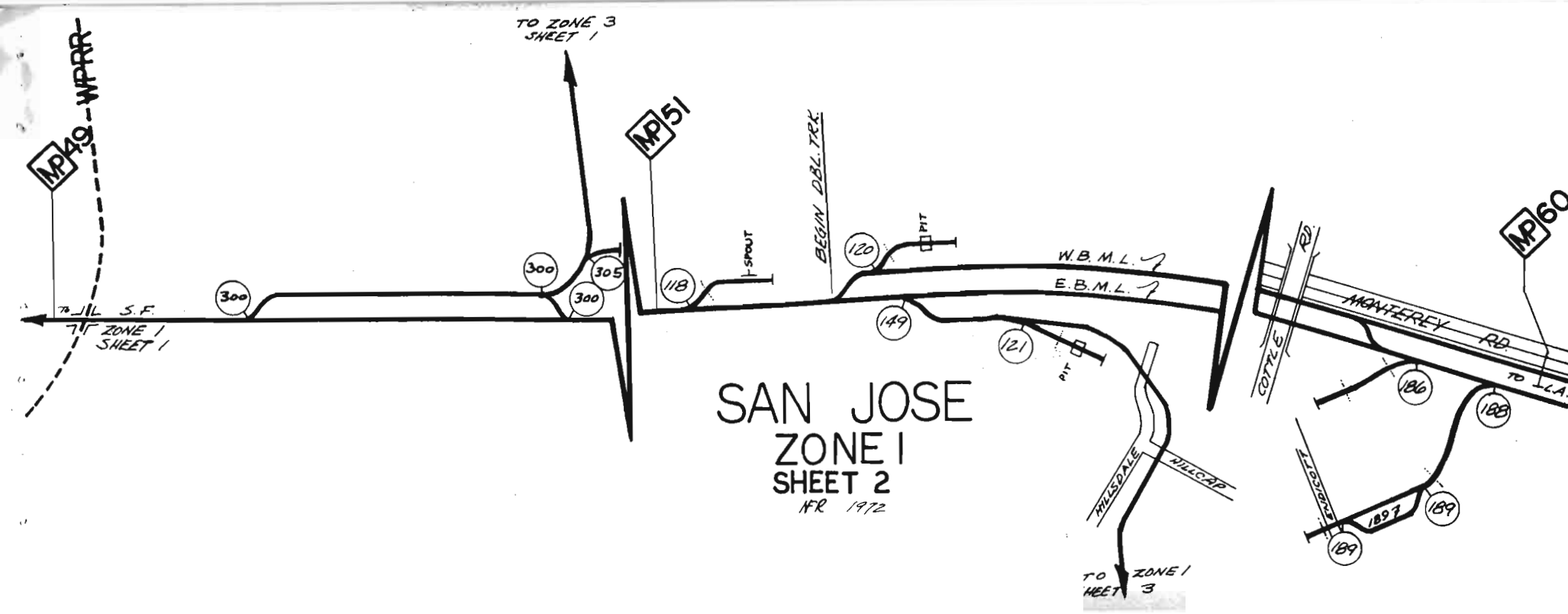
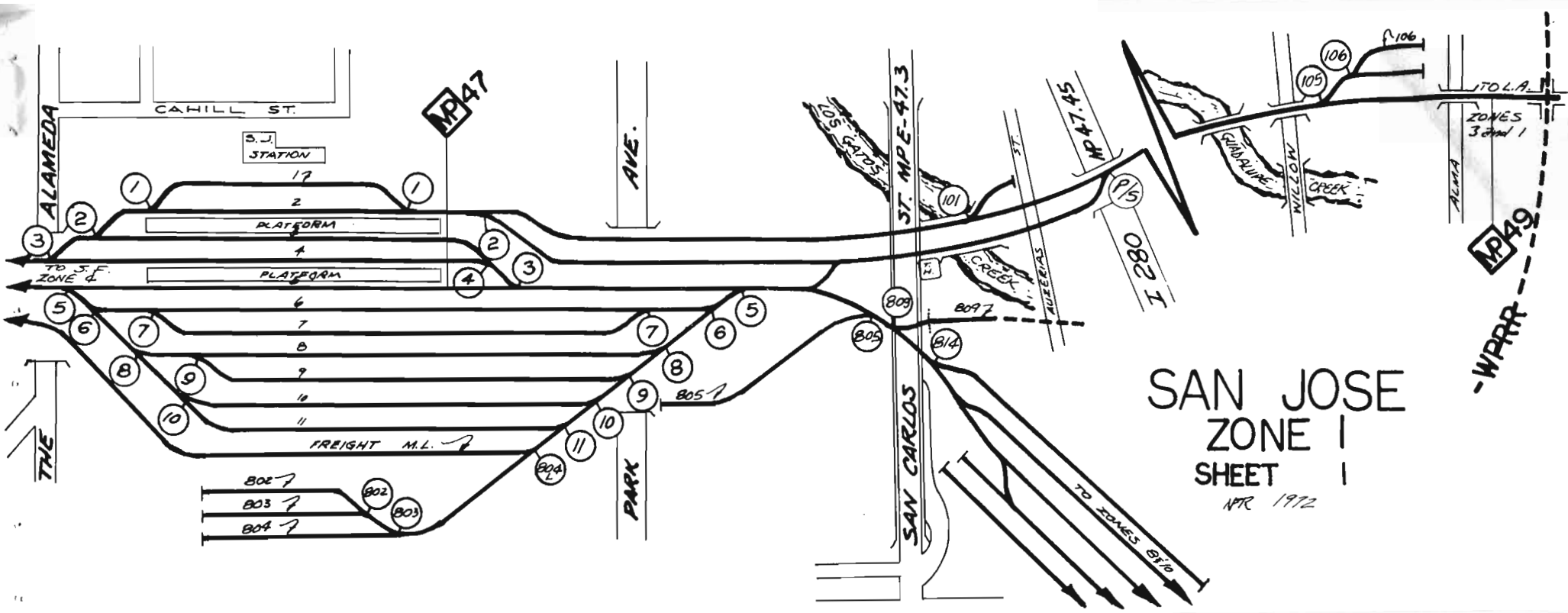

ZONE 2
SANTA CLARA AREA

Track No.	Industry
200	Lead Track
201	Lead Track
202	Lead Track
203	FMC - (DTL)
205	Jos. George Distr.
206	U.S. Plywood
207	Jos. George Distr.
213	FMC - John Bean Divm. #2
214	FMC - Ordinance Divm. #3 (ramp)
215	FMC - Ordinance Divm. #3
220	Provenzano Bros.
221	Variety Merchandise Corp.
221	Beaver Lumber Co.
222	Simpson Wholesale Co.
224	Georgia Pacific Paper
224	Royal Fibre Co.
226	Vacant
228	Animal Foods
228	Unitas Inc.
229	Lead Track
231	General Electric Supply
232	Container Corp. of America
232	Cal. Container Corp.
233	Container Corp. of America
233	Cal. Container Corp.
235	Container Corp. of America
235	Cal. Container Corp.

SAN JOSE
ZONE 1
SHEET 3
APR 1972

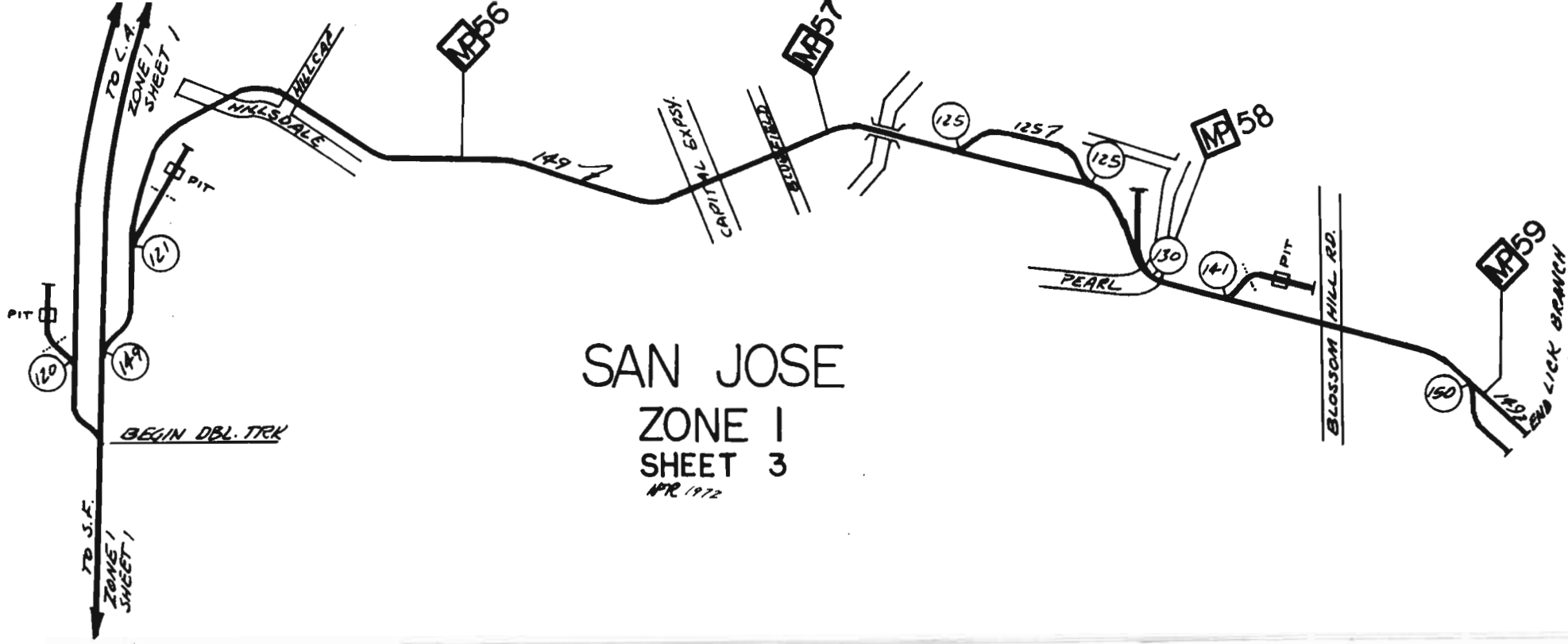

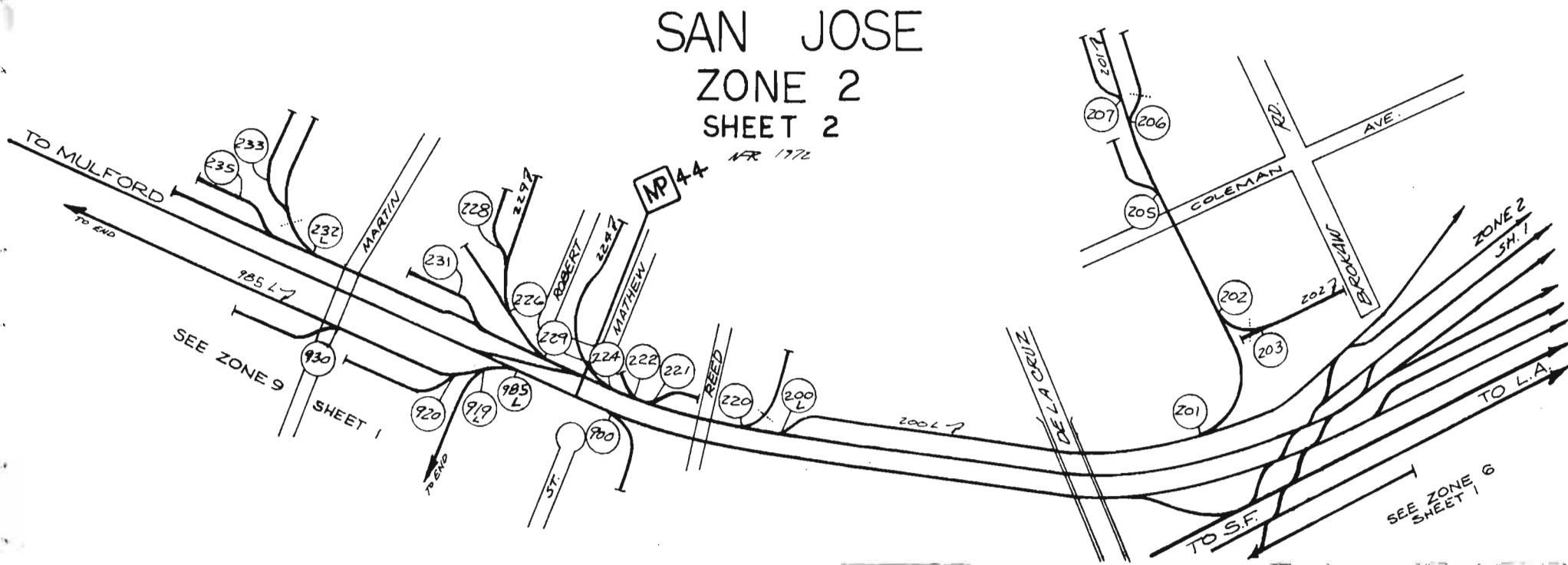
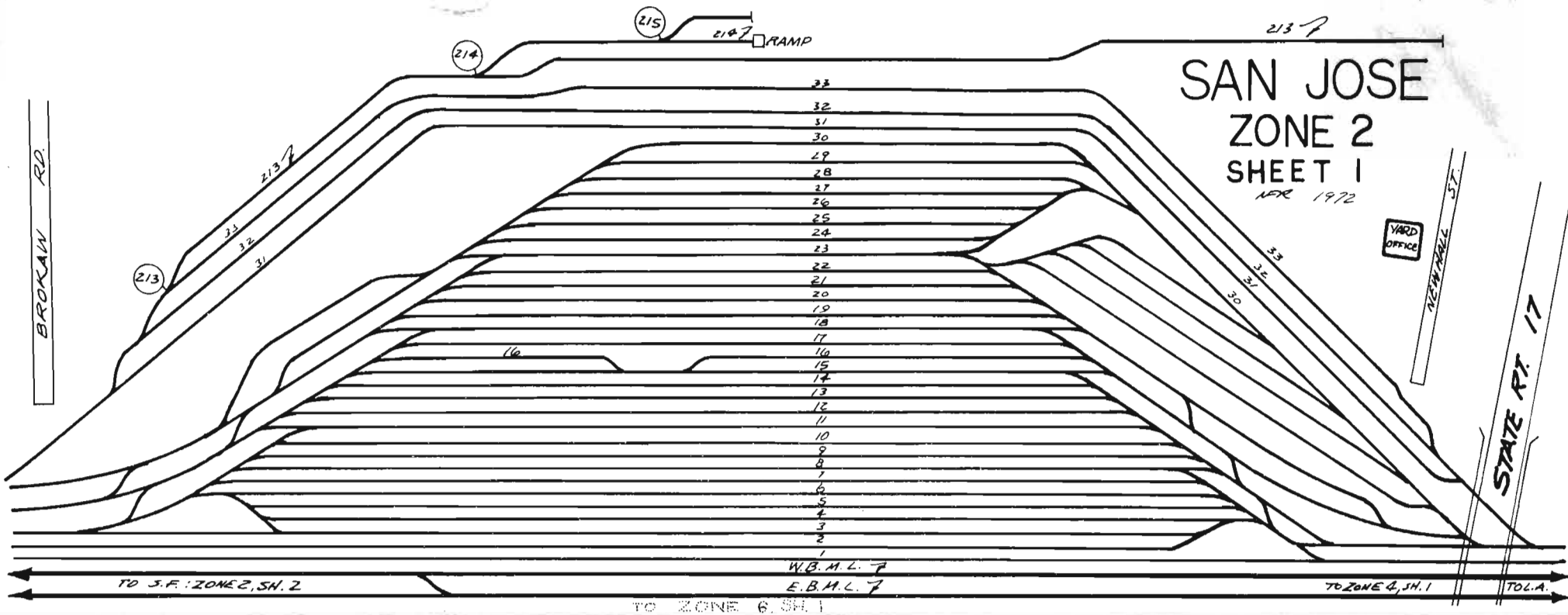

ZONE 3
SAN JOSE AREA
(cont.)

ZONE 3
SAN JOSE AREA

Track No.	Industry
370	Valbrick Team Track
371	SP Transfer to WP
372	SP Transfer to SP
375	Sunsweet Growers Inc.
375	Growers Packing & Whse.
376	Almaden Vineyards
381	Almaden Vineyards
384	D'Amico Tire Service Co.
384	Cal. Fruit Concentrates
384	Cal. Swamp Products
384	Commerce Swamp Products
384	Joy of California
384	H.V. Lorentz
385	Vacant

Track No.	Industry
300	SP Runaround
300	Luther Lead Track
305	Pacific Ready Mix (PCA)(pit)
311	Contadina Foods, Whse.
312	Ac'cent International Interchange Track
313	Ac'cent International Interchange Track
314	General Electric (motor plant)
315	General Electric (atomic plant)
321	Luther Team Track
322	SP Passing Track
323	Monarch Match Co.
327	Doud Lumber
327	Oatey, Inc.
328	Grinnel Co. of Pacific
329	Lead Track
333	Mayfair Packing Co.
339	Burke Rubber Company
341	Bidou's Bakery
342	Burke Rubber Company
343	Freund Baking Co.
343	Western States Distr.
344	F.C. Wool Packing Co.
345	Levin Machinery & Salvage Co.
346	Levin Machinery & Salvage Co.
347	Levin Machinery & Salvage Co.
348	Levin Machinery & Salvage Co.
349	Levin Machinery & Salvage Co.
350	Levin Machinery & Salvage Co.
351	Aeromotive Metals
351	Sportsliner Inc.
351	Loadeze
351	Gurries Mfg. Co.
352	Alloy Wire Bolt
353	SP Runaround
354	Vacant
355	Sun Garden Packing Co.
355	American Can Co.
356	Southern Lumber Co.
357	Area Distributors
358	Ramar, Inc.
358	Goldeens Furniture
360	Beechnut Packing Co.
361	American Bakery
363	Ford Products
364	King Stucco
369	Lead Track
369	Beechnut Packing Co. (end)

(cont.)

ZONE 4
SANTA CLARA AREA

Track No.	Industry
400	Congate Juvenile Products Co.
400	Gerald Stein Co. of Cal.
401	Shell Oil Co.
403	Phillips Petroleum Co.
405	Coleman Team Track (crane)
406	TOFC Track {ramp}
407	TOFC Track {ramp}
408	TOFC Track {ramp}
409	TOFC Storage
410	Auto Unloading Track
411	Classification & Storage
412	Classification & Storage
413	Classification & Storage
414	Classification & Storage
415	Classification & Storage
416	Classification & Storage
417	Classification & Storage
418	Classification & Storage
419	Classification & Storage
420	Milpitas Main Line
421	Classification & Storage
422	Classification & Storage
423	Classification & Storage
424	Classification & Storage
425	Rip Track
425	E.I. DuPont - DeNemours
426	Repair Track
427	Storage Dept. Loading Track
428	Heavy Repairs Track
429	Heavy Repairs Track
430	Pacific Motor Trucking (PMT)
431	Pacific Motor Trucking (PMT)
432	Cal. Cannery & Growers #4
433	Cal. Cannery & Growers #4
434	Keystone Wholesale Grocers
434	San Jose Potato & Onion
435	Vacant
436	Vacant
442	Vacant
444	Vacant
446	Seiberling Rubber Co.
446	Harold Johnson
447	Storage Track
448	Storage Track
449	Storage Track

(cont.)

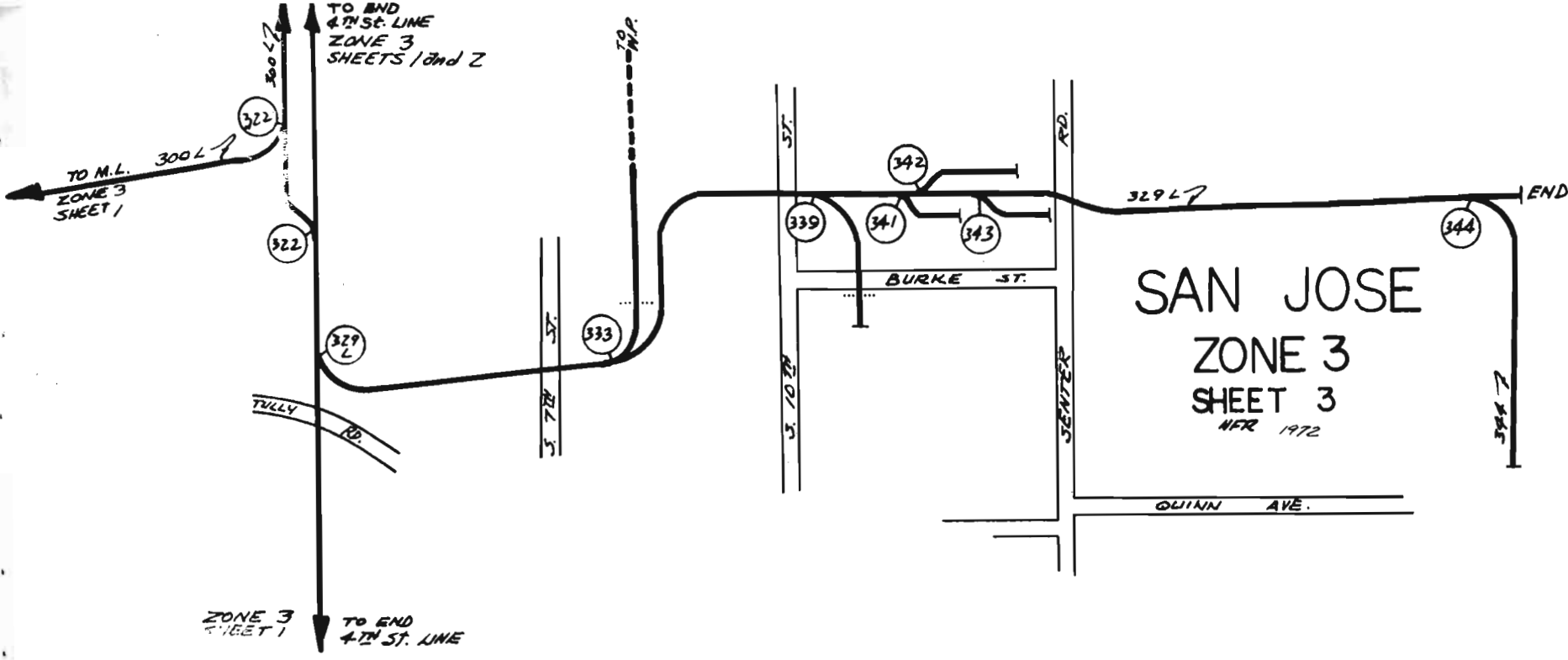

ZONE 4
SANTA CLARA AREA
(cont.)

Track No.	Industry
450	San Augustine St. Team Track
470	Vacant
471	FMC - Canning Division #1
472	National Biscuit Co.
473	FMC - Canning Division #1
474	Vacant
475	Lead Track
475	FMC - Canning Division #1
475	Mel Cottons, Inc. (door 4)
475	Conway Import Co.
475	Lyons Home Furnishings
476	FMC - Canning Division #1
477	Independent Paper Stock
477	Tom Doyle
477	Western Appliance
478	Old Freight Hse. Team Track
478	T & G Forklift Sales Co.
478	A-1 Refrigeration
483	PCA (pit)
484	Vacant
485	PCA
485	Pottery Sales
485	R.L. Youman
486	Vacant
490	Muirson Label
490	Falstaff Brewing
491	Falstaff Brewing
492	Falstaff Brewing
494	Cal. Canners & Growers #4 (syrup)
494	Cal. Canners & Growers #4

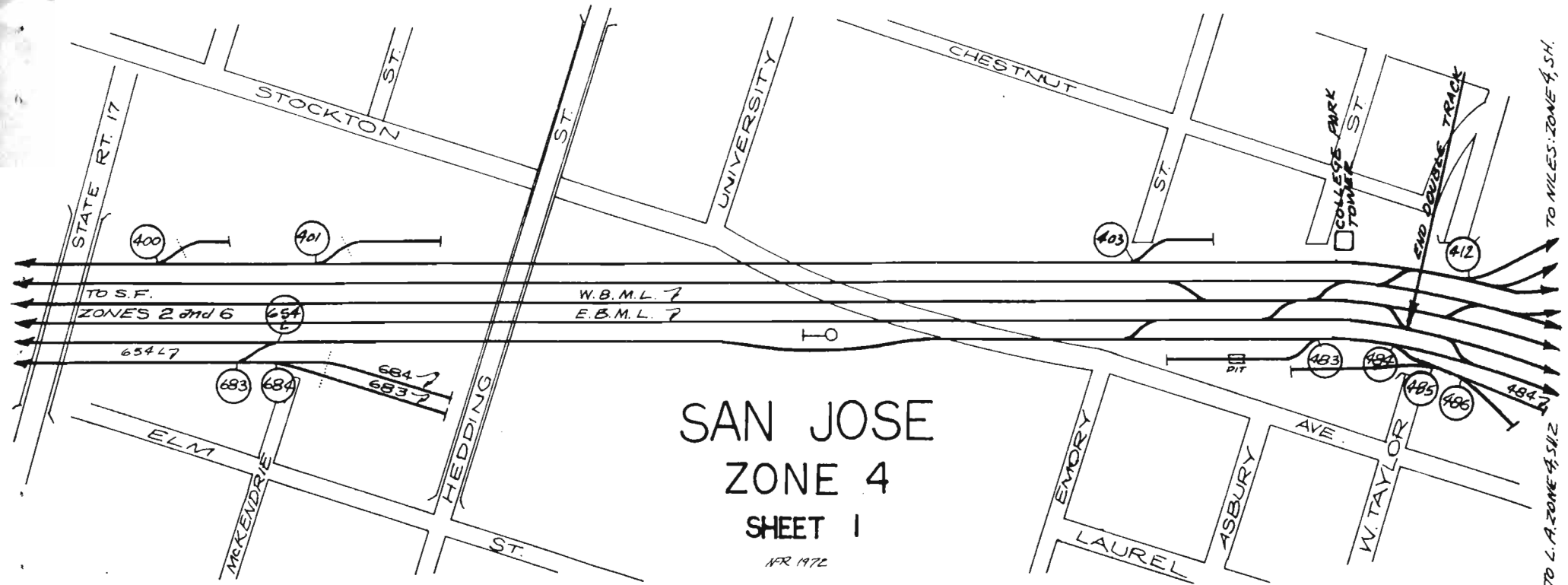

ZONE 5
SAN JOSE AREA

Track No.	Industry
500	North S.J. Ind'l. Pk. Lead Track
520	Lead Track
525	Pioneer Distributors
526	Lake Sales
550	Rogers Avenue Team Track
551	Fibreboard Corp. (pit)
552	Fibreboard Corp.
560	Lead Track
568	Kragen Auto Supply
570	Lead Track
575	SP Runaround
578	Montgomery Ward
580	Lead Track
584	Hollingshead
585	Arcata Graphics
586	Scott Paper
588	Lash Distributors
588	Novelty Distributors
590	Data Transportation

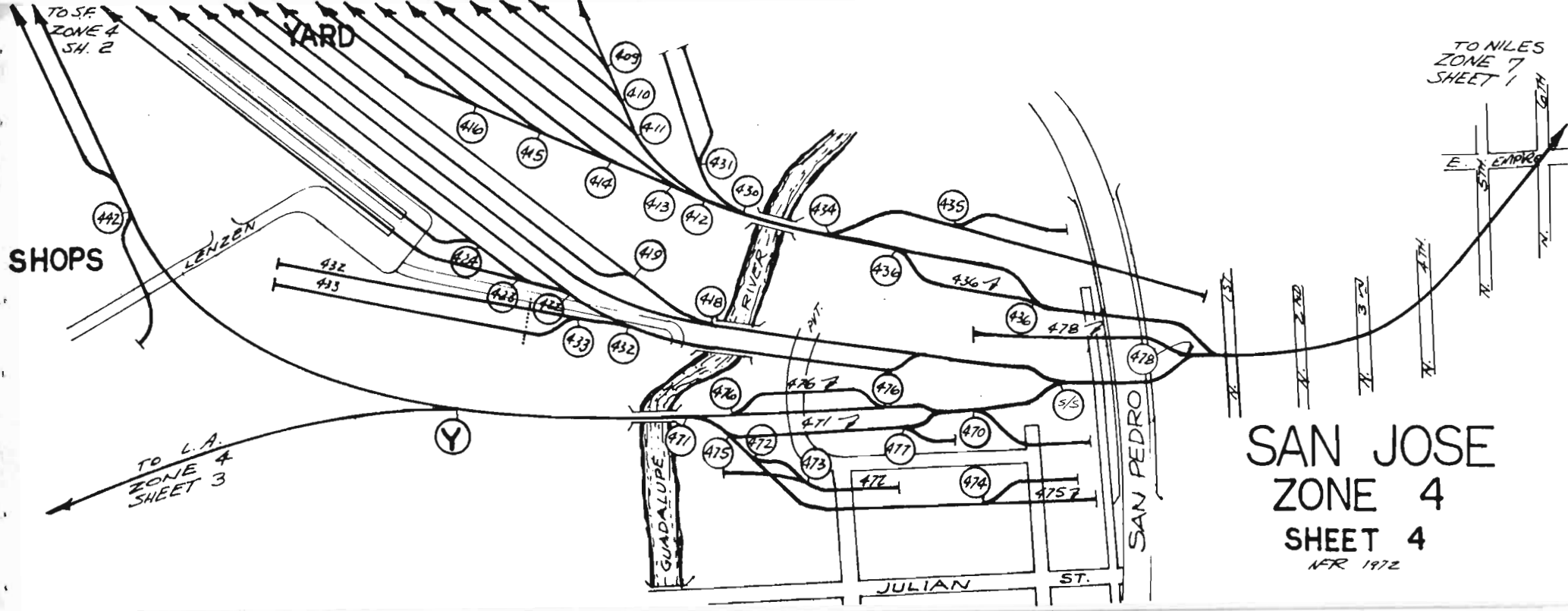

SAN JOSE
ZONE 4
SHEET 4
NFR 1972

ZONE 6
SANTA CLARA AREA

Track No.	Industry
610	Western Castings
630	Valley Rockery
632	Drywall Supply
633	Lead Track
636	SP Runaround Track
637	Amaral Plumbing
638	Mayfair Packing Co. #4
640	Lead Track
641	Pratt Lowe Division Duffy Mott
642	Vacant
643	Owens Illinois Glass Co.
651	Merchants Refrigerating
653	Vacant
654	Lead Track
654	Vacant (end)
560	Lead Track
660	Pratt Lowe Division Duffy Mott(end)
661	Pratt Lowe Division Duffy Mott
662	Drywall Supply
663	Drywall Supply
663	Pratt Lowe Division Duffy Mott
670	Sur-T
670	John Bruner
671	Santa Clara Team Track
680	Vacant
681	Stokeley Van Camp (perishable)
682	Kanda Corporation
683	Vacant
684	Vacant

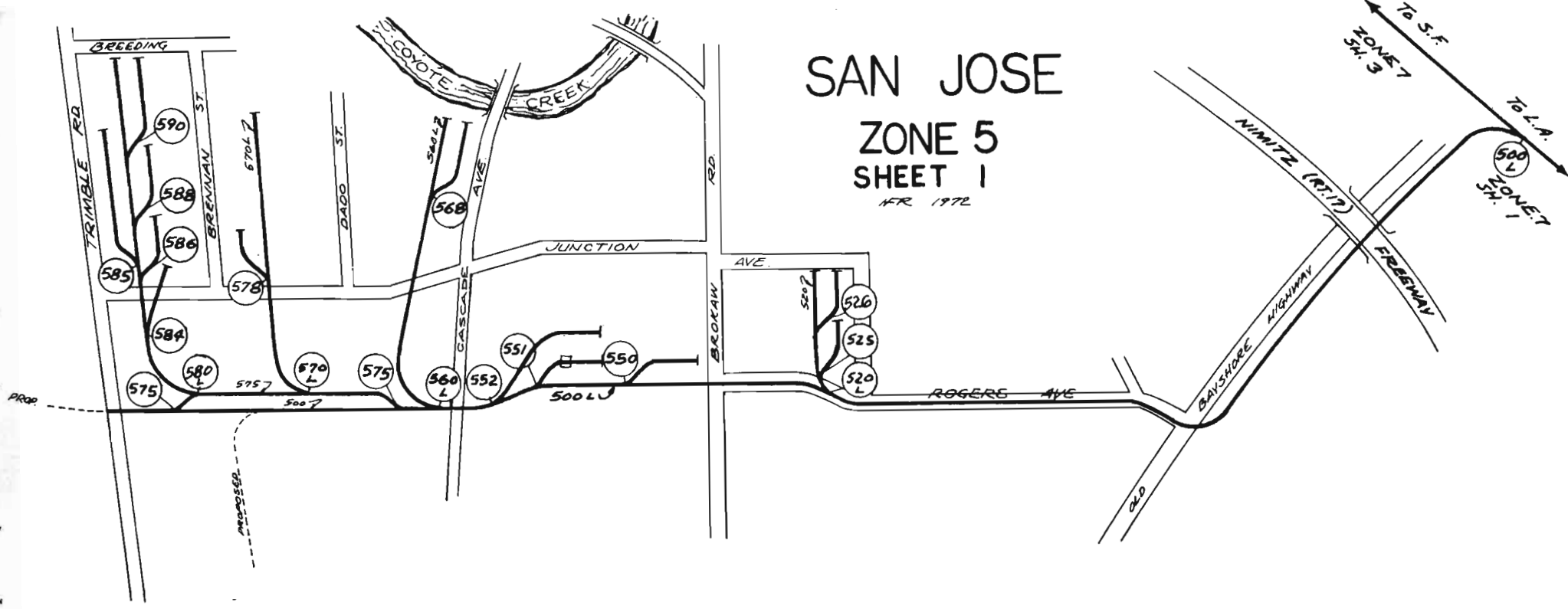

SAN JOSE
ZONE 5
SHEET 1
HFR 1972

ZONE 7
SAN JOSE AREA

Track No.	Industry
703	Garden City Pottery
704	Vacant
706	DMC - Del Monte Corp. #39
707	Lead Track
708	Vacant
709	Standard Produce
709	Gem Produce
709	Amerian Bros.
709	L.F. Clark
710	Continental Can Co.
711	S.C. Packing Co.
712	DMC - Del Monte Corp. #39
713	DMC - Del Monte Corp. #39
714	DMC - Del Monte Corp. #39
715	DMC - Del Monte Corp. #39
715	Continental Can Co.
716	Continental Can Co.
717	Continental Can Co.
718	Continental Can Co.
719	Continental Can Co.
722	Vacant
730	Lead Track
730	United Centrifugal Pumps (end)
732	Cristina Warehouse
733	Cristina Warehouse
735	Moore & Clark
736	Vacant
737	Brunswig Drug Company
737	Coffin Reddington
738	Vacant
740	Lead Track
741	Lead Track
741	Modern Ice & Cold Storage (end)
741	Naturipe Berry Growers (end)
742	Allied Container Co.
742	Pioneer Sawdust and Sand
743	Modern Ice & Cold Storage
744	Luna Park Team Track
755	Garden Valley Fertilizer
756	Storage Track
757	Airdrome Orchards
757	Al Caviglia
757	Cal. Fruit Exchange
757	Paul's Pak
758	Georgia Pacific (Lumber Division)
759	Weyerhaeuser Co. (Wood Prod.Divm.)

(cont.)

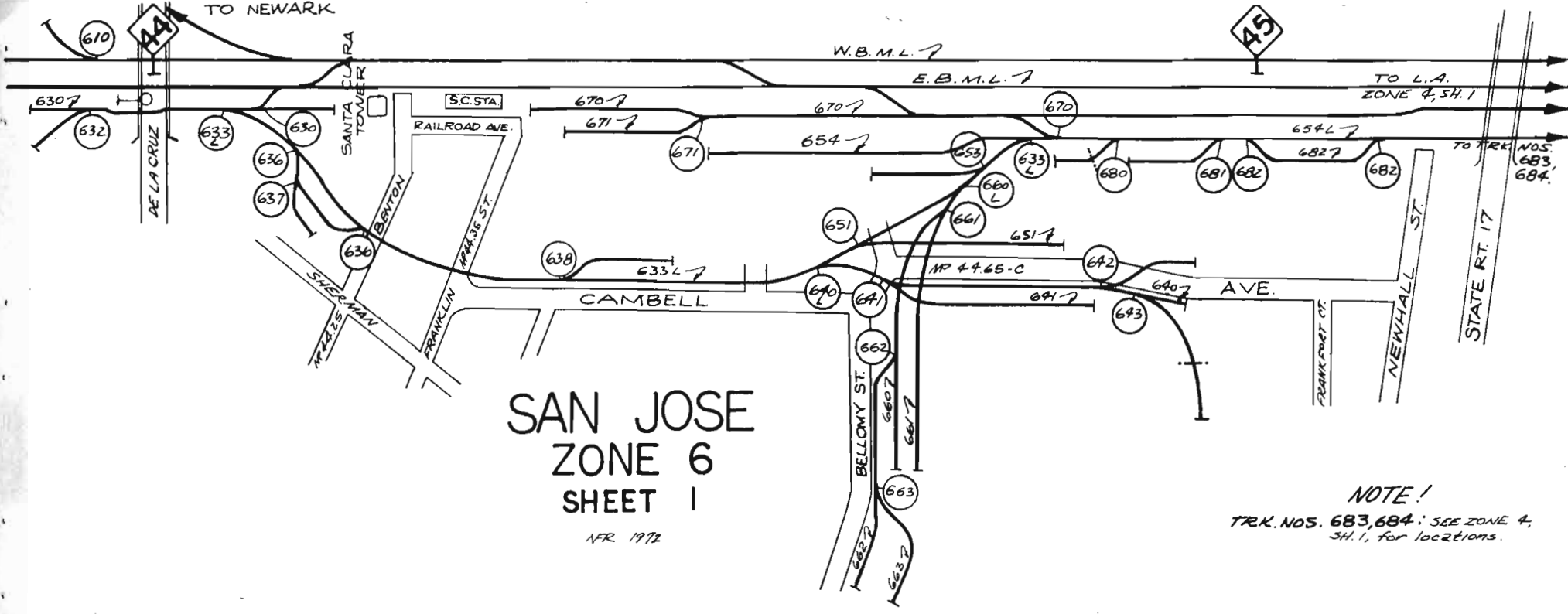

ZONE 7
SAN JOSE AREA
(cont.)

Track No.	Industry
762	Western Plumbing
765	Granite Rock
766	SP Passing Track
768	San Jose Meat Company
769	Wayne Basket Company
769	General Box Distributors
770	N. California Fertilizer
791	Crane Supply Company
793	Harrell International
794	S.C. County Service Center
795	Northwest Publication
795	San Jose Mercury News
797	Markovitz & Fox
798	Markovitz & Fox
799	Markovitz & Fox

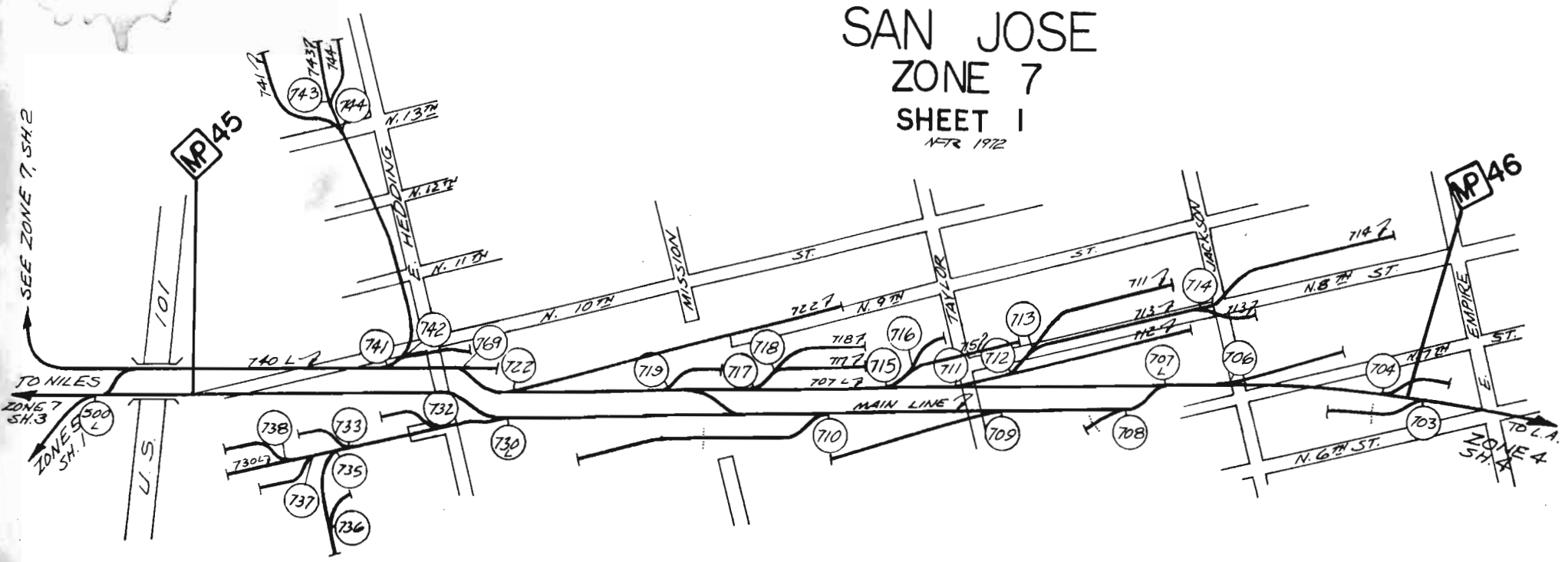

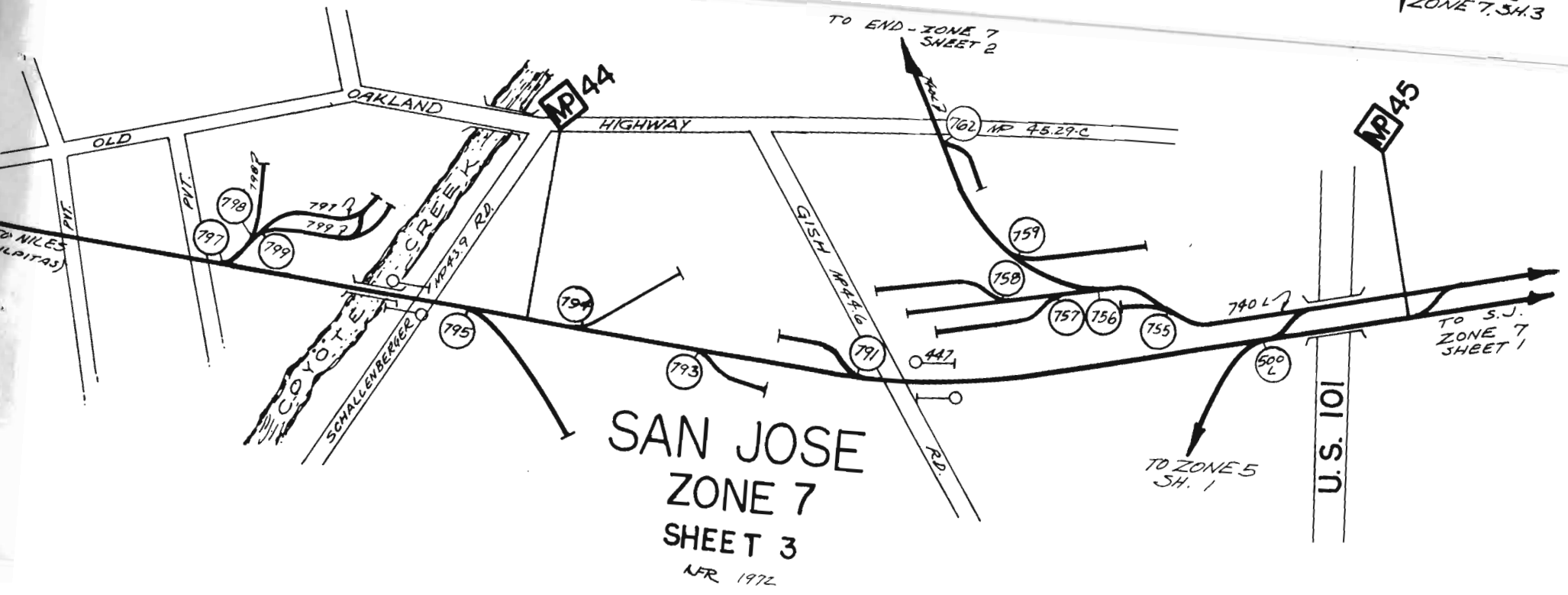
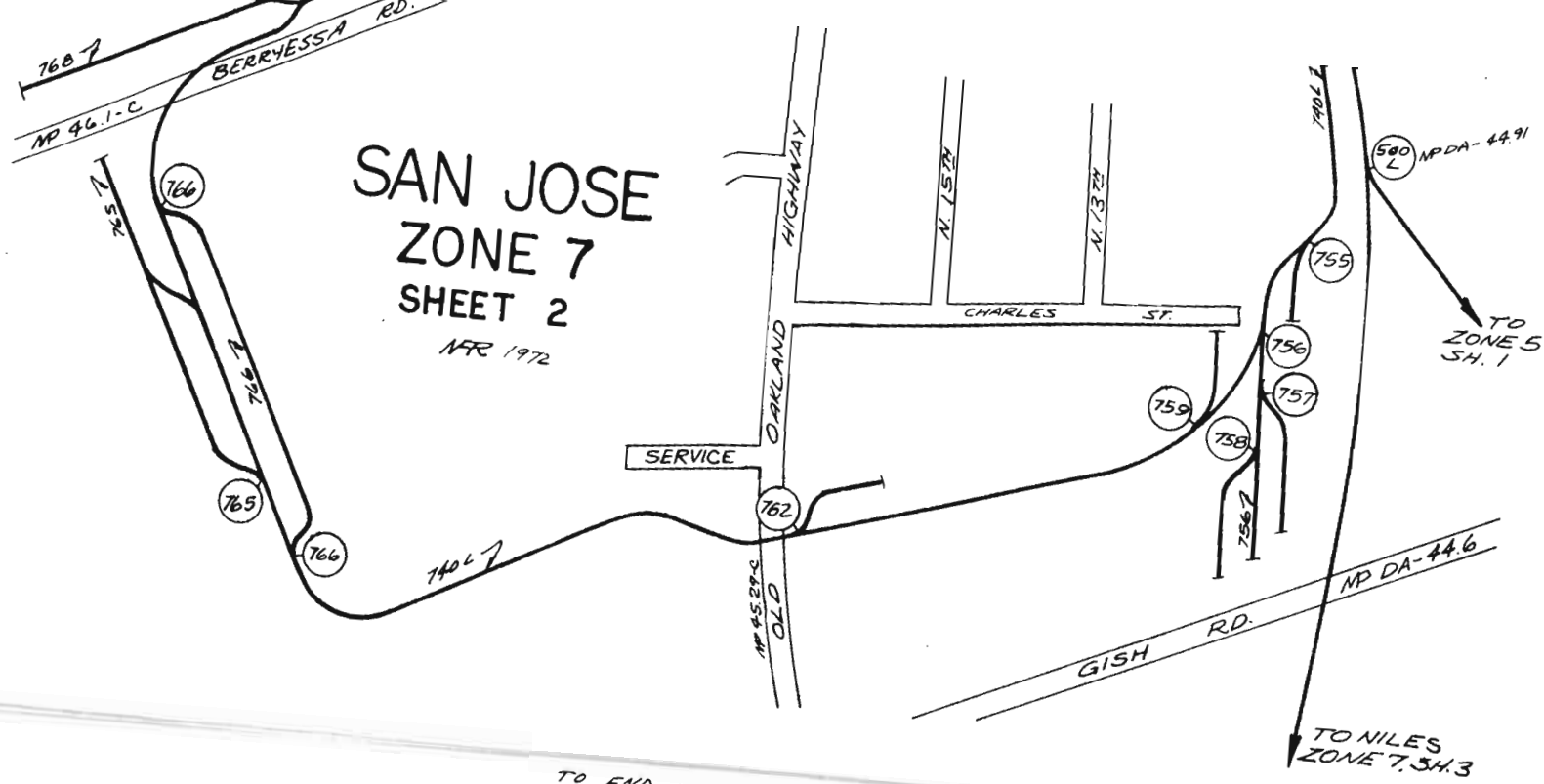

ZONE 8
CAMPBELL AREA

Track No.	Industry
800	San Jose Unified School Dist.
802	Storage Commute Fleet
803	Storage Commute Fleet
804	Lead Track
804	DMC-Del Monte Corp. #51 (end)
805	Pik-Nik Food Products
805	George L. Burger
809	DMC - Del Monte Corp. #3
810	Lead Track
811	Storage Track
812	Cheim Lumber
813	Cheim Lumber
814	DMC-Del Monte Corp. #3
815	Lead Track
816	Standard Oil
818	Auzerais St. Team Track
820	Hank & Frank Drayage
822	U.S. Products Corp.
823	U.S. Products Corp.
825	U.S. Products Corp.
826	U.S. Products Corp.
827	U.S. Products Corp.
830	Contadina Divn. Carnation Co.
831	SP Runaround Track
870	Vacant
871	Parker Roofing Co.
871	Larson Products Co.
872	Vacant
873	Storage Track
874	SP Passing Track
875	SP Runaround Track
876	Campbell Team Track
878	Connat Bldg. Materials (pit)
880	Economy Lumber Co.

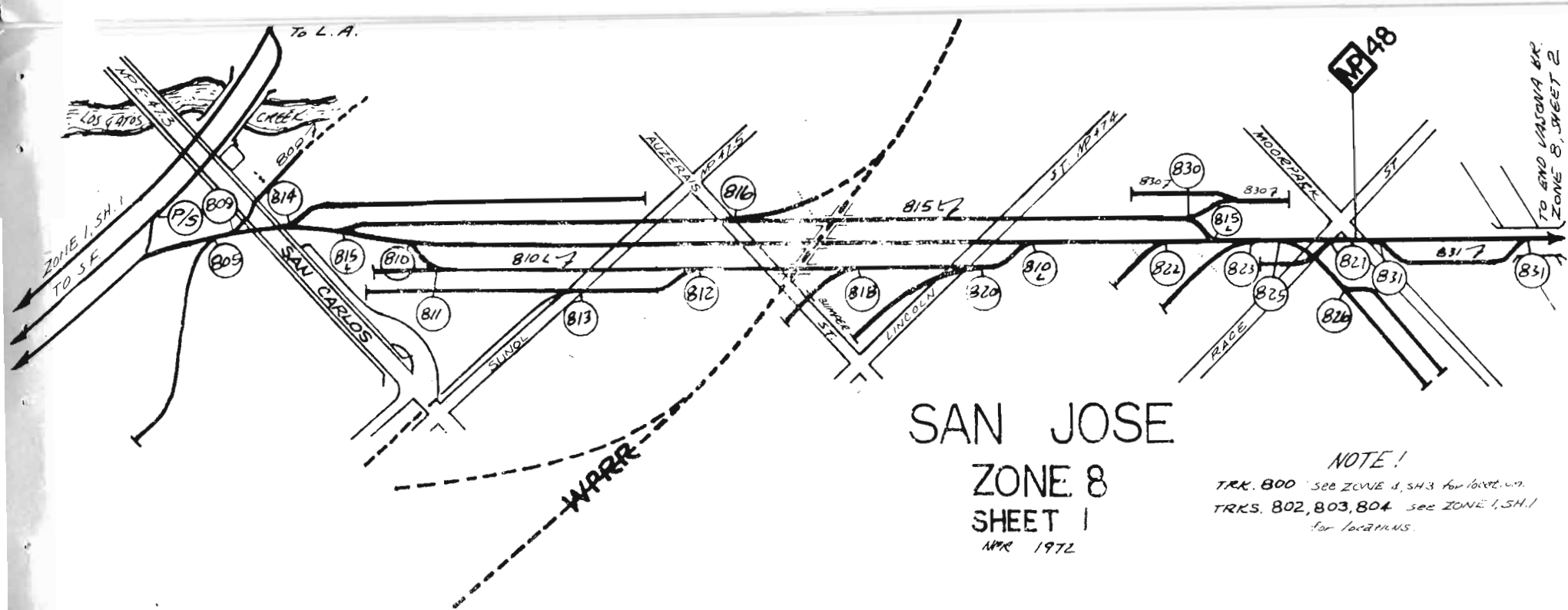

NOTE!
TRK. 800 see ZONE 4, SH.3 for locat. etc.
TRKS. 802, 803, 804 see ZONE 1, SH.1
for locations.

ZONE 9
SANTA CLARA AREA

Track No.	Industry
900	Pacific Supply
903	Larson Ladder Co.
904	Diana Fruit Preserving
904	Ganri Bros. Packing
905	Brown Co.
906	Woodall Industries
907	Clark Equipment Company
907	James Dunn
907	Levy Zentner Company
909	H. S. Crocker Company
909	Shaw Insulating
910	Screw Conveyor
911	Sommers O'Rear & Stephens
919	Lead Track
919	Eichlay Corp. (end)
920	Sanspray Industries Inc.
930	Larson Ladder
940	Lead Track
941	Customer Utility
942	Havlin Witking
942	Panal Plastics
943	Norton Company
944	U.S. Products #2
946	Norton Company
947	Pacific Nursery Company
950	Beall Refrigeration
950	Technical Coating Corporation
951	Pacific Nursery Pots
953	Laminated Paper Products
954	Felton Aluminum
955	S.C. Cold Storage & Freezer Co.
955	S.C. Valley Fruit Exchange
955	S.C. Pear
955	Mariani Frozen Foods
965	Keystone Steel & Wire
970	Lead Track
971	Armstrong Cork & Tile
972	Owens-Corning Fiberglass
973	Owens-Corning Fiberglass
974	Owens-Corning Fiberglass
975	Owens-Corning Fiberglass
976	Monsanto Chemical Co.
977	Monsanto Chemical Co.
978	Owens-Corning Fiberglass
979	Owens-Corning Fiberglass
980	Owens-Corning Fiberglass
981	Owens-Corning Fiberglass
982	Owens-Corning Fiberglass
983	Owens-Corning Fiberglass
984	Certainteed Products
985	Lead Track
985	Certainteed Products (end)

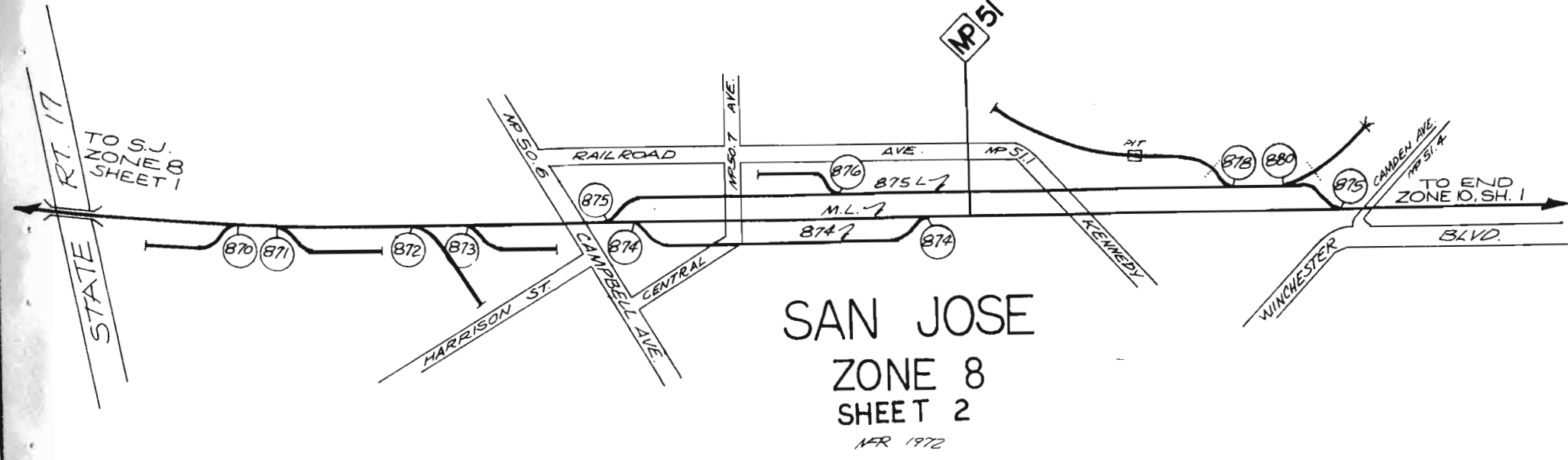

ZONE 10
SERVED BY PERMANENTE LOCAL

Track No.	Industry
1001	Campbell Lumber
1003	R.V. Cloud
1006	IBM - Card Plant
1010	Bard-Parker Divn. Becton, Dickinson of California
1012	Vasona Team Track
1020	Paul Masson Vineyards
1021	Paul Masson Vineyards
1022	Paul Masson Vineyards
1023	SP Runaround Track
1060	Richard Woelffel Cannery
1065	Monta Vista Team Track
1085	Kaiser Aluminum Company
1085	Kaiser Cement & Gypsum

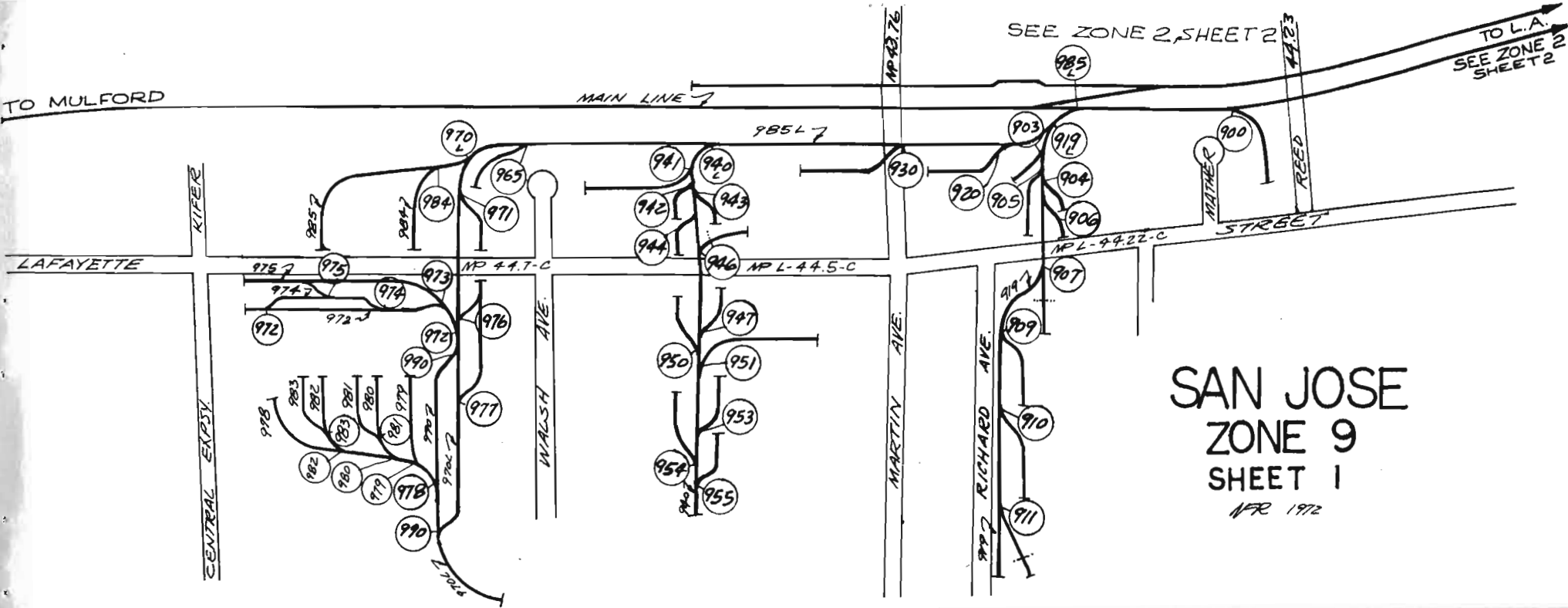

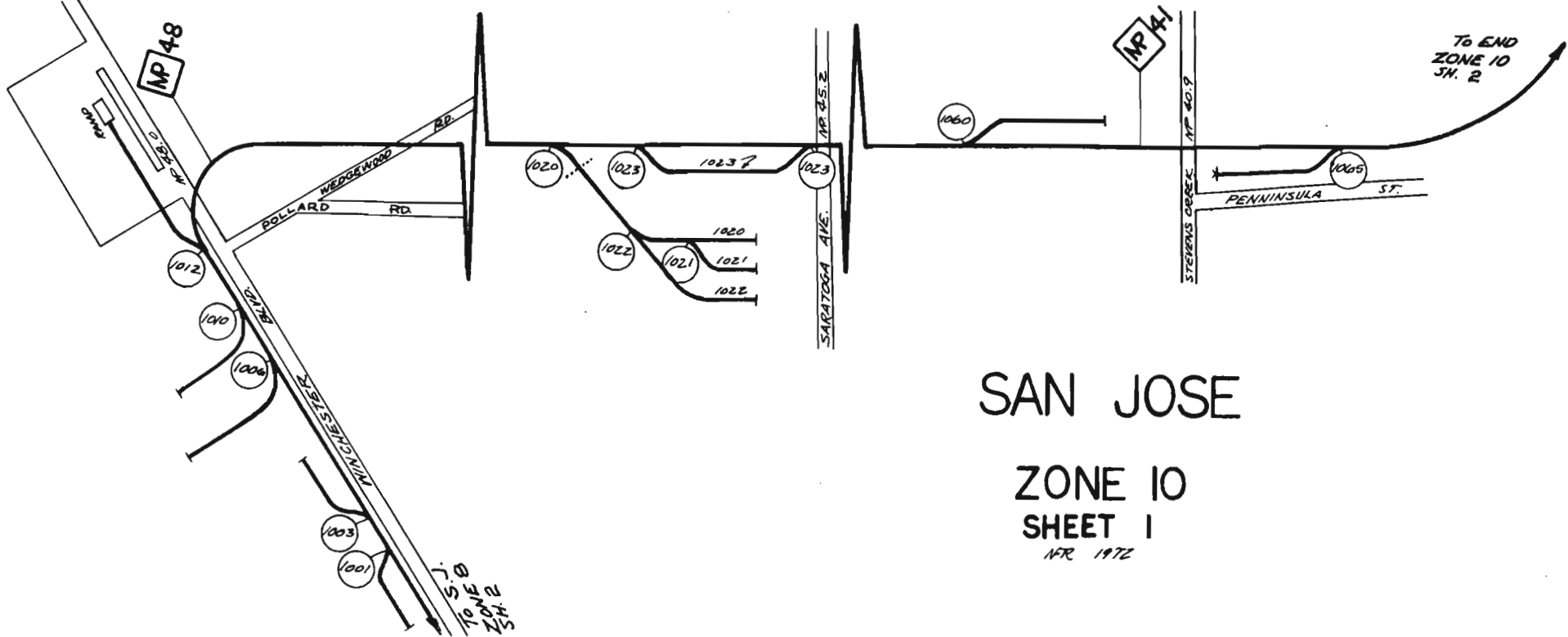

SAN JOSE

ZONE 10
SHEET 1

NFR 1972

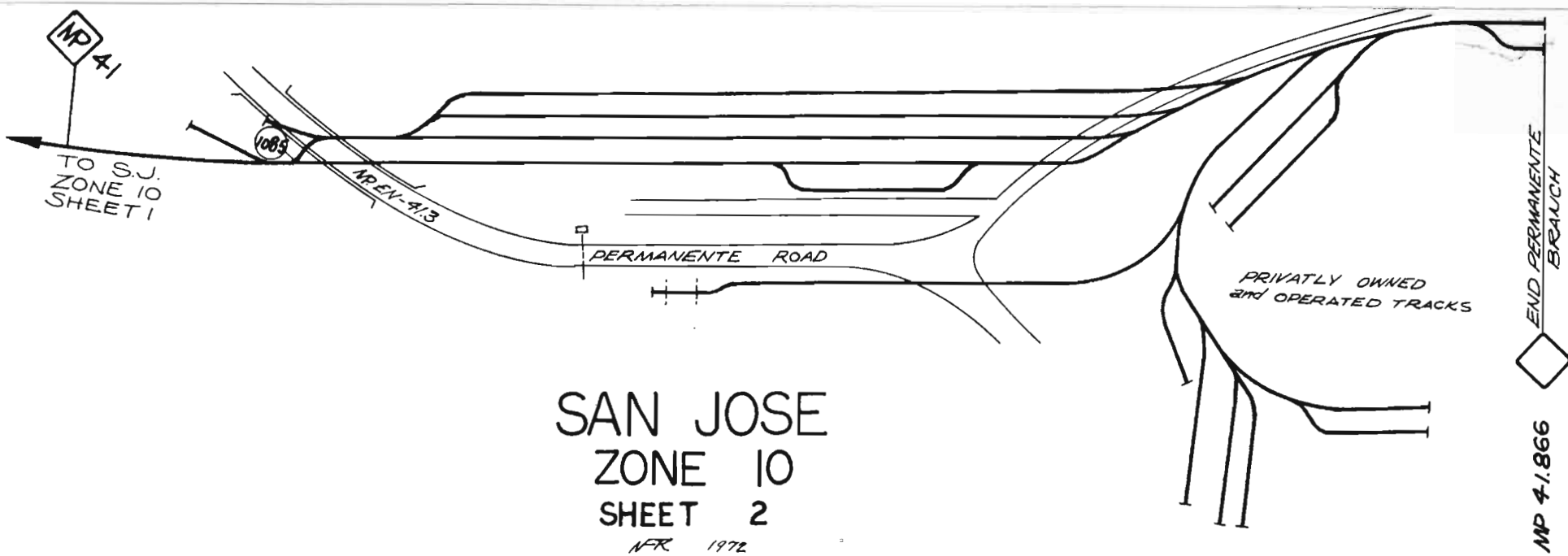

SAN JOSE
ZONE 10
SHEET 2

NFR 1972

END PERMANENTE
BRANCH

MP 41.866