

BITUMINOUS & ANTHRACITE

COAL MINES

THE PENNSYLVANIA RAILROAD

AND

LATERAL LINES



**ALPHABETICAL AND GEOGRAPHICAL LIST OF
BITUMINOUS AND ANTHRACITE COAL MINES**
on
The PENNSYLVANIA RAILROAD and LATERAL LINES
with
Names and Post Office Address of Operators

COAL TRAFFIC SALES AND RATES

GENERAL MANAGER

W. P. Stuart
Philadelphia 4, Pa.

MANAGERS

A. L. Graburn, Jr.
Philadelphia 4, Pa.

M. E. Klein
Chicago 6, Ill.

H. H. Lippold
Pittsburgh 22, Pa.

C. J. Hendrickson
New York 1, N. Y.

ASSISTANT MANAGERS

R. W. Wilkins
Philadelphia 4, Pa.

F. R. Weis
Pittsburgh 22, Pa.

L. J. Lynn
Chicago 6, Ill.

J. H. Cairns
Philadelphia 4, Pa.

E. R. Richardson
New York 1, N. Y.

MANAGER—COAL TRAFFIC RESEARCH AND DEVELOPMENT

W. L. Lloyd
Philadelphia 4, Pa.

COAL AND ORE TRAFFIC SALES AND RATES

Manager
J. B. Carey
Cleveland 14, Ohio

Assistant Manager
W. S. Mahle
Cleveland 14, Ohio

COAL SALES SUPERVISORS

At Boston 14, Mass.
W. Sargent, Ill

At Cincinnati 2, Ohio
W. B. Neal

At Buffalo 4, N. Y.
C. E. Starr

At Detroit 26, Mich.
G. W. Mikesell

**ADDITIONAL INFORMATION MAY BE SECURED BY COMMUNICATING WITH THE
FOLLOWING FREIGHT SALES REPRESENTATIVES**

Akron 8, Ohio—Mill and Summit Sts. F. K. Price, District Sales Manager	Montreal 2, Que.—303 Dominion Square Bldg., 1010 St. Catherine St., West George H. Keown, District Sales Manager
Albany 7, N. Y.—4 Plaza William O. Peairs, District Sales Manager	Newark 2, N. J.—910 Chamber of Commerce Bldg., 20 Branford Place Wesley M. Anthony, District Sales Manager
Altoona, Pa.—32 Pennsylvania R. R. Bldg., 9th Ave. and 12th St. Francis T. Brown, District Sales Manager	New Haven 10, Conn.—307 WBIB Bldg., 157 Church St. Richard L. Boring, District Sales Manager
Baltimore 1, Md.—321 Pennsylvania Station, 1515 N. Charles St. Elmer R. Norris, District Sales Manager	New York 1, N. Y.—420 P. R. R. Sta., 7th Ave. and 34th St John A. Prince, District Sales Manager Percy C. Cornes, Assistant District Sales Manager
Boston 14, Mass.—713 North Station, 150 Causeway St. Leo H. Dickman, Sales Manager, New England States	Norfolk 10, Va.—Royster Bldg., Granby St. and City Hall Ave. James M. C. Collins, District Sales Manager
Buffalo 4, N. Y.—P. R. R. Freight Terminal, Seneca and Louisiana Sts. Donald J. Collins, District Sales Manager	Omaha 2, Neb.—1017 City National Bank Bldg., 16th and Harney Sts. Harold W. Johnson, District Sales Manager
Camden 3, N. J.—24 Federal St. Nicholas B. Fagan, District Sales Manager	Peoria 2, Ill.—1140-41 Jefferson Bldg., 331 Fulton St. Ned W. Culmer, District Sales Manager
Canton 2, O.—Pennsylvania Station, 846 Market Ave., South Arthur A. Metz, District Sales Manager	Philadelphia 4, Pa.—252 Pennsylvania Station (30th St.) John R. Deming, District Sales Manager Leslie M. Cox, Assistant District Sales Manager
Chicago 7, Ill.—Room 401, 323 W. Polk St. Harold P. Bates, District Sales Manager Marvel A. Nickey, Assistant District Sales Manager	Pittsburgh 22, Pa.—825 Pennsylvania Station, Liberty Ave. and Grant St. Benjamin F. Isenberg, District Sales Manager
Cincinnati 2, O.—805 Swift Bldg., 230 E. Ninth St. Frank H. Hillgartner, District Sales Manager	Reading, Pa.—P. R. R. Frt. Sta., 536 S. Fifth St. George A. Harnischfeger, District Sales Manager
Cleveland 3, O.—307 Cook Bldg., 4614 Prospect Ave. Leo J. Moran, District Sales Manager Harry R. Bell, Assistant District Sales Manager	Richmond, Ind.—Room 1, Union Station, 10th and North E Sts. Arthur V. Hitchcock, District Sales Manager
Columbus 15, O.—330 N. High St., Corner High and Naghten Sts. Orville P. Varnell, District Sales Manager	Rochester 8, N. Y.—Pennsylvania Station Bldg., 357 Main St., West Albert W. Lenhard, District Sales Manager
Davenport, Iowa—905 Kahl Bldg., 326 W. 3rd St. Norman P. Steele, District Sales Manager	St. Louis 1, Mo.—Room 1010, 915 Olive St. Ross D. Clemens, District Sales Manager Leonard H. Lee, Assistant District Sales Manager
Dayton 2, O.—420 Washington St. Nathan W. Hawkes, Jr., District Sales Manager	Scranton, Pa. Office—111 E. Northampton St., Wilkes-Barre, Pa. Rudolph G. Lange, District Sales Manager
Des Moines 9, Iowa—624 Fleming Bldg., 6th and Walnut Sts. Irvin Schneeberg, District Sales Manager	South Bend 23, Ind.—701 S Main St. Theodore W. Hoke, District Sales Manager
Detroit 26, Mich.—430 Buhl Bldg., 535 Griswold St. George R. Wallace, District Sales Manager	Syracuse, N. Y.—504 Loew Bldg., S. Salina and W. Jefferson Sts. James P. Royston, District Sales Manager
Easton, Pa.—408-9 Alpha Bldg., S. W. Cor. Center Sq. and S. 3rd St. Joseph N. Peirsol, District Sales Manager	Terre Haute, Ind.—7 Union Station Fred W. Konze, District Sales Manager
Elmira, N. Y.—P. R. R. Frt Sta., 5th and Hatch Sts. Frank B. Hoffman, District Sales Manager	Toledo 4, O.—Pennsylvania Sta., 1220 Summit St. Oren B. Peterson, District Sales Manager
Erie 6, Pa.—313 Union Station, 14th and Peach Sts. Charles E. Williams, District Sales Manager	Toronto 1, Ont.—69 Yonge St. Silas S. Salter, Sales Manager, Canada
Fort Wayne 2, Ind.—P. R. R. Station, Baker and Harrison Sts. Richard M. Roth, District Sales Manager	Trenton 5, N. J.—P. R. R. Frt. Sta., N. Olden Ave., P. O. Box 825 Lindsay O. Holt, District Sales Manager
Grand Rapids 2, Mich.—Pennsylvania Bldg., Ionia Ave. and Weston St. Howard L. Gordon, District Sales Manager	Uniontown, Pa.—60 N. Mt. Vernon Ave. Robert M. Tillotson, District Sales Manager
Hagerstown, Md.—P. R. R. Station, Walnut and Washington Sts. Robert H. Dowie, District Sales Manager	Washington 5, D. C.—626 14th St., N.W. Walter K. Howard, District Sales Manager Royce A. Nickey, Assistant District Sales Manager J. Walter Horrocks, Assistant District Sales Manager
Harrisburg, Pa.—Pennsylvania Station Joseph R. Thomas, District Sales Manager	Wheeling, W. Va.—P. R. R. Passenger Sta., 11th and Water Sts. Charles H. Wolfinger, District Sales Manager
Indianapolis 25, Ind.—305 Union Station, S. Illinois St. and Jackson Place William P. Hammond, District Sales Manager	Williamsport, Pa.—P. R. R. Station, 1st Ave. and Nichols Place Frederick B. Vandegrift, District Sales Manager
Kansas City 6, Mo.—536 Railway Exchange Bldg., 7th and Walnut Sts. James T. Gurren, District Sales Manager	Wilmington 1, Del.—314 Pennsylvania Bldg., Front and French Sts. Romain F. Meyer, District Sales Manager
Louisville 3, Ky.—P. R. R. Frt. Sta., 1301 W. Portland Ave. Joseph A. Sladen, District Sales Manager	*York, Pa.—P. R. R. Frt. Sta., North and Duke Sts. William S. Boyd, District Sales Manager
Milwaukee 2, Wis.—1410 First Wisconsin National Bank Bldg., 735 N. Water St. Lawrence J. Logsdon, District Sales Manager	Youngstown 3, O.—P. R. R. Passenger Sta., W. Federal St. at North Ave. Charles J. Lindquist, District Sales Manager
Minneapolis 2, Minn.—720 Rand Tower, Marquette Ave. and 6th St., South Willis R. McAfee, District Sales Manager	Zanesville, O.—P. R. R. Station, 2nd and Market Sts. Richard H. George, District Sales Manager

TABLE OF CONTENTS

	Page		Page
ANTHRACITE COAL:		LATERAL LINES, LIST OF	3
Map	59	MAPS:	
Mines, Alphabetical list of	57	Anthracite	59
Mines, Geographical list of	58	Bituminous, East of Pittsburgh, Pa.—Map A	39
Operators	57	Bituminous, West of Pittsburgh, Pa.—Map B	47
BITUMINOUS COAL:		Bituminous, Illinois and Indiana—Map C	55
Maps		P. R. R. System Showing Coal Measures and Regions ..	4, 5
A—East of Pittsburgh, Pa.	39	MINES, ALPHABETICAL AND GEOGRAPHICAL LIST OF:	
B—West of Pittsburgh, Pa.	47	Anthracite	57, 58
C—Illinois and Indiana	55	Bituminous, East of Pittsburgh, Pa.	19 to 22, 25 to 35
Mines, List of		Bituminous, West of Pittsburgh, Pa.	41 to 43
East of Pittsburgh, Pa.		Bituminous, In Illinois and Indiana	53
Alphabetical	19 to 22	NOTICE OF CHANGES IN NAMES OF MINES, ETC.	6
Geographical	25 to 35	OPERATORS, ALPHABETICAL LIST OF:	
West of Pittsburgh, Pa.		Anthracite	57
Alphabetical	41	Bituminous	9 to 17
Geographical	42, 43	SALES REPRESENTATIVES (FREIGHT), LIST OF ...	2
Illinois and Indiana		TRANSSHIPPING FACILITIES:	
Alphabetical	53	Ashtabula, Ohio (Ashtabula Dock)	51
Geographical	53	Baltimore, Md. (Canton Piers)	24
Operators	9 to 17	Cleveland, Ohio (Cleveland Dock)	49
CHANGES IN NAMES OF MINES, ETC., REPORTING OF	7	Conway, Pa. (Conway Coal Dock)	45
COAL CAR EQUIPMENT (PENNSYLVANIA RAILROAD), DESCRIPTION OF	61 to 68	Erie, Pa. (Erie Docks)	50
FACILITIES		Philadelphia, Pa. (Greenwich Piers)	23
Lake	37, 49 to 52	Pittsburgh (Jacks Run), Pa., (Verner Dock)	44
River	44, 45	Sandusky, Ohio (Sandusky Docks)	52
Tidewater	23, 24, 36	Sodus Point, N. Y.	37
FREIGHT SALES REPRESENTATIVES	2	South Amboy, N. J. (New York Harbor)	36

LIST OF LATERAL LINES

<p>CAMBRIA & INDIANA RAILROAD COMPANY</p> <p>CHERRY TREE & DIXONVILLE RAILROAD COMPANY</p> <p>CHESWICK & HARMAR RAILROAD</p> <p>CONEMAUGH & BLACK LICK RAILROAD</p> <p>JOHNSTOWN & STONY CREEK RAILROAD</p> <p>LAKE ERIE, FRANKLIN & CLARION RAILROAD COMPANY</p> <p>MONONGAHELA RAILWAY</p>	<p>MONTOUR RAILROAD COMPANY</p> <p>PITTSBURGH & WEST VIRGINIA RAILWAY</p> <p>PITTSBURGH, CHARTIERS & YOUGHIOGHENY RAILWAY COMPANY (THE)</p> <p>SMITHFIELD & MASONTOWN BRANCH</p> <p>UNITY RAILWAYS COMPANY</p> <p>WESTERN ALLEGHENY RAILROAD COMPANY</p> <p>YOUNGSTOWN & SOUTHERN RAILWAY COMPANY</p>
--	---

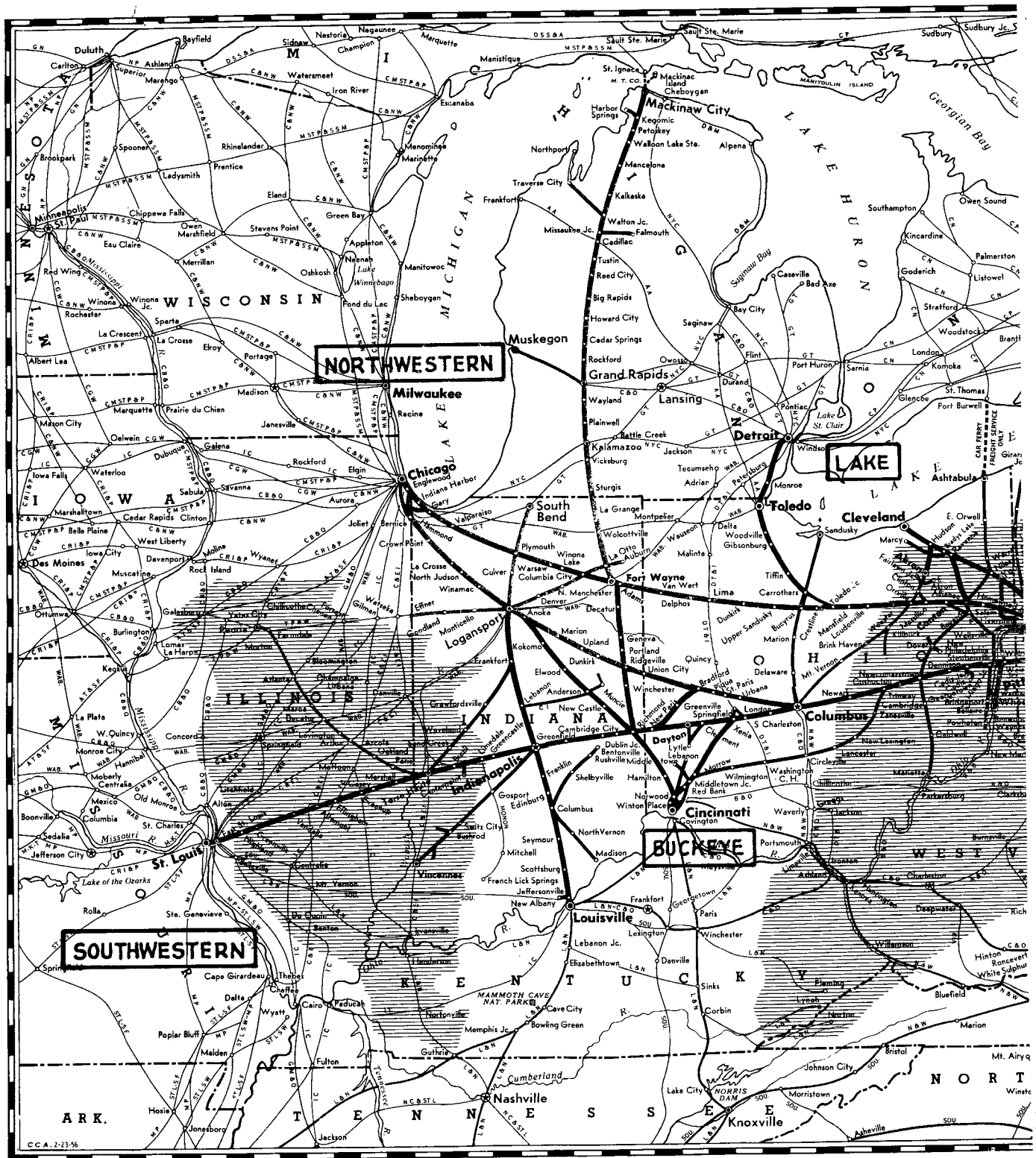

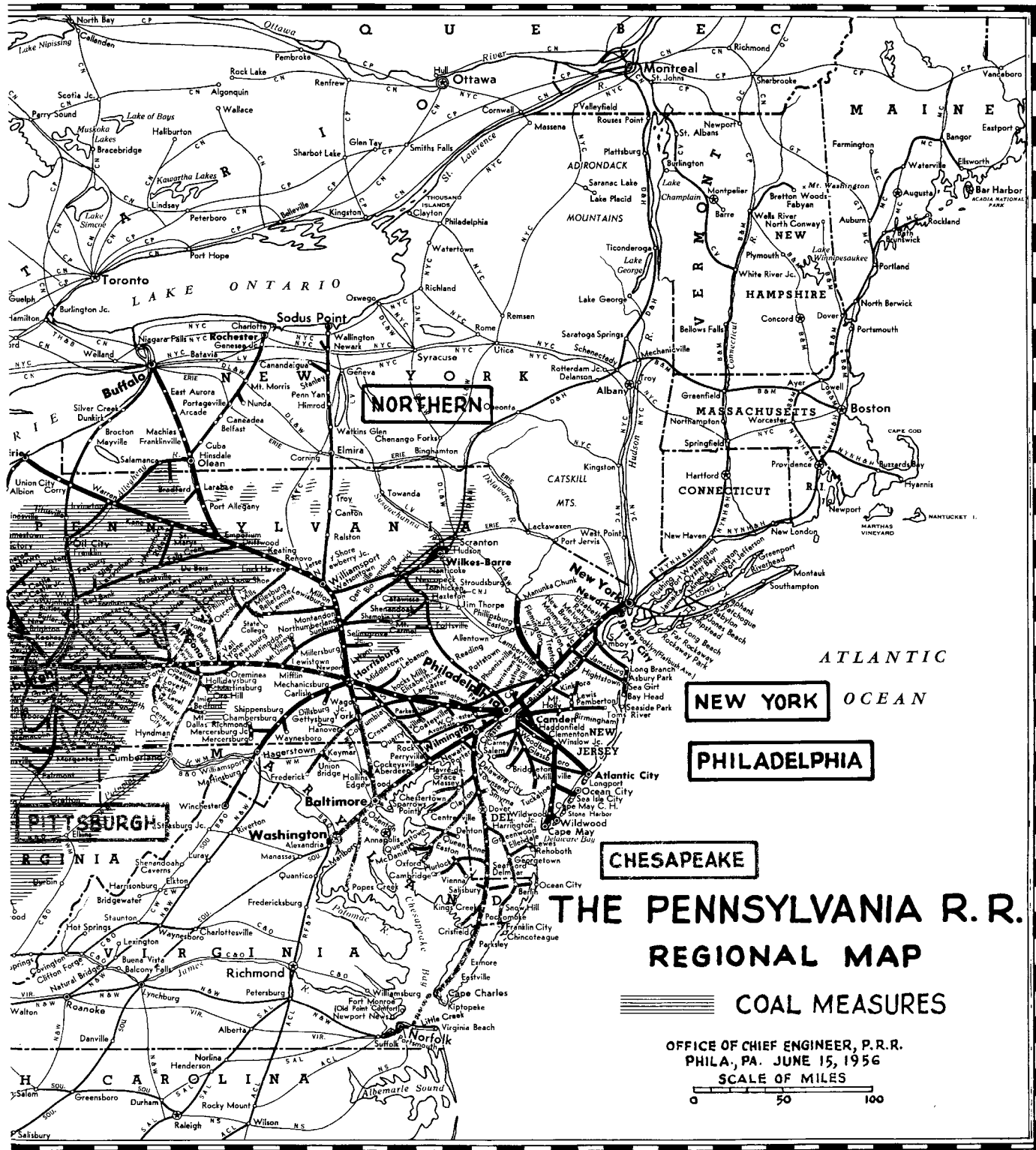

NOTICE

Mines, operators, etc., published in issue hereby canceled and not shown herein have been either abandoned or changed.

It is requested that any changes in names of mines, operators, post office addresses, etc., be immediately reported to any of the following offices:

Manager, Coal Traffic Sales and Rates	Philadelphia 4, Pa.
Manager, Coal Traffic Sales and Rates	Pittsburgh 22, Pa.
Manager, Coal Traffic Sales and Rates	Chicago 6, Ill.
Manager, Coal Traffic Sales and Rates	New York 1, N. Y.
Manager, Coal and Ore Traffic Sales and Rates	Cleveland 14, Ohio

ATTENTION, PLEASE:

These perforated sections are included for your convenience in advising of any changes or corrections required in this publication. If you will forward such information to one of the offices listed on the "Notice" page, corrections will be made in the next supplement issued.

3.

2.

**CHANGES OR CORRECTIONS
TO
PENNSYLVANIA RAILROAD
C. D. 6.**

3.

**CHANGES OR CORRECTIONS
TO
PENNSYLVANIA RAILROAD
C. D. 6.**

2.

**CHANGES OR CORRECTIONS
TO
PENNSYLVANIA RAILROAD
C. D. 6.**

1.

ALPHABETICAL LIST OF OPERATORS OF BITUMINOUS COAL MINES ON THE PENNSYLVANIA RAILROAD AND LATERAL LINES

OPERATOR	P. O. ADDRESS	MINE	STATE	SECTION	INDEX No.
Adams Fuel Corp.	South Fork Pa.	Riverside No. 2	Pa.	A	184
Adamsburg Coal Co.	Adamsburg Pa.	Adamsburg	Pa.	A	243
Allison Engineering Co.	Allison Park Pa.	Allison No. 12	Pa.	A	379
Aloe Coal Co., Wm.	Imperial Pa.	Rider No. 4	Pa.	B	13
Altmire Bros. Coal Co.	Vandergrift Pa.	Altmire	Pa.	A	353
Altmire Bros. Coal Co.	Vandergrift Pa.	Beck	Pa.	A	358
Altmire Bros. Coal Co.	Vandergrift Pa.	Bleriot	Pa.	A	359
Altmire Bros. Coal Co.	Vandergrift Pa.	Cherry Run	Pa.	A	354
Altmire Bros. Coal Co.	Vandergrift Pa.	June	Pa.	A	357
Altmire Bros. Coal Co.	Vandergrift Pa.	Relco	Pa.	A	355
Amos Coal Corp., C. L.	220 East Washington St., Syracuse 1 N. Y.	Amos No. 6	Pa.	A	377
Anita Coal Mining Co.	Punxsutawney Pa.	Anita Dock	Pa.	A	117
Anita Coal Mining Co.	Punxsutawney Pa.	Anita No. 1	Pa.	A	118
Anita Coal Mining Co.	Punxsutawney Pa.	Brady Run Dock	Pa.	A	106
Anita Coal Mining Co.	Punxsutawney Pa.	Spencer & Mauk	Pa.	A	391
Apex Coal Co., Inc.	Fourth & Border Sts., West Elizabeth Pa.	Alice No. 2	Pa.	A	419
Appalacha Coal Co.	Box 51, Indiana Pa.	Appalacha	Pa.	A	341
Apple Coal Mng. Co.	Fallen Timber Pa.	Cambria Mills No. 2	Pa.	A	90
Apple Coal Mng. Co.	Fallen Timber Pa.	Cambria Mills No. 3	Pa.	A	79
Apple Coal Mng. Co.	Fallen Timber Pa.	Decca Nos. 2 & 3	Pa.	A	200
Argyle Coal Co.	1st National Bank Bldg., Johnstown Pa.	Bennington "B"	Pa.	A	168
Arrow Coal Corp.	Windber Pa.	Arrow	Pa.	A	203
Ayrshire Patoka Collieries	Indianapolis Ind.	Chinook	Ind.	C	2
"B" Quality Coal Co.	Windber Pa.	"B" Quality No. 8	Pa.	A	217
"B" Quality Coal Co.	Windber Pa.	"B" Quality No. 9	Pa.	A	201
B. & V. Coal Co.	1303 Airport Rd., R. D. No. 6, Pittsburgh 27 Pa.	Garrett Run	Pa.	A	370
Bailey and Caskey	Coalport Pa.	Laurel Run No. 1	Pa.	A	72
Baker, C. H.	Box 243, Uniontown Pa.	C. H. Baker Siding	Pa.	A	273
Baker Ridge Coal Co.	816 Madison Ave., Morgantown W. Va.	Baker Ridge Mine	W. Va.	A	305
Barilar Coal Co., Inc.	Anita Pa.	Barilar	Pa.	A	115
Barnes & Tucker Co.	Barnesboro Pa.	Lancashire No. 15	Pa.	A	125
Barnes & Tucker Co.	Barnesboro Pa.	Lancashire No. 20	Pa.	A	121
Barnes & Tucker Co.	Barnesboro Pa.	Renglo	Pa.	A	151
Beechnut Coal Co.	118 Graham St., Windber Pa.	Beechnut No. 1	Pa.	A	199
Beechnut Coal Co.	118 Graham St., Windber Pa.	Windber Hi-Standard	Pa.	A	187
Belfast Coal Co.	Clearfield Pa.	Belfast No. 2	Pa.	A	69
Benjamin Coal Co.	Ansonville Pa.	Benjamin No. 3	Pa.	A	102
Bens Creek Coal Co.	Johnstown Pa.	Bens Creek No. 1	Pa.	A	228
Berwind-White Coal Mng. Co.	Pennsylvania Bldg., Phila. 2 Pa.	Eureka No. 37	Pa.	A	197
Berwind-White Coal Mng. Co.	Pennsylvania Bldg., Phila. 2 Pa.	Eureka No. 40	Pa.	A	196
Berwind-White Coal Mng. Co.	Pennsylvania Bldg., Phila. 2 Pa.	Maryland Shaft	Pa.	A	185
Berwind-White Coal Mng. Co.	Pennsylvania Bldg., Phila. 2 Pa.	Maryland Shaft No. 2	Pa.	A	179
Bethlehem Mines Corp. (Bethlehem Steel Co.)	Bethlehem Pa.	Bethlehem No. 51	Pa.	A	255
Bethlehem Mines Corp. (Bethlehem Steel Co.)	Bethlehem Pa.	Bethlehem No. 58	Pa.	A	258
Bethlehem Mines Corp. (Bethlehem Steel Co.)	Bethlehem Pa.	Bethlehem No. 60	Pa.	A	256
Bethlehem Mines Corp. (Bethlehem Steel Co.)	Bethlehem Pa.	Bethlehem No. 72	Pa.	A	233
Bethlehem Mines Corp. (Bethlehem Steel Co.)	Bethlehem Pa.	Bethlehem No. 73	Pa.	A	232
Bethlehem Mines Corp. (Bethlehem Steel Co.)	Bethlehem Pa.	Bethlehem No. 74	Pa.	A	230
Bethlehem Mines Corp. (Bethlehem Steel Co.)	Bethlehem Pa.	Monroe 31	Pa.	A	156
Bethlehem Mines Corp. (Bethlehem Steel Co.)	Bethlehem Pa.	Monroe 32	Pa.	A	158
Bigan Coal Co.	Windber Pa.	Bigan Nos. 22 & 23	Pa.	A	204
Bigelow Run Coal Co.	Philipsburg Pa.	Bigelow Run	Pa.	A	48
Bird Coal Co.	Tire Hill Pa.	Bird No. 3	Pa.	A	227
Black Lick Coal Mining Co. (Fred McFadden)	Ebensburg Pa.	Commercial No. 5	Pa.	A	149
Blose, C. E.	Punxsutawney Pa.	Blose Dock	Pa.	A	116
Blue Crystal Mines, Inc.	Millersburg O.	Blue Crystal	O.	B	62
Bortz Coal Co.	Uniontown Pa.	Daugherty No. 2	Pa.	A	337
Bowers Coal Co.	Coalport Pa.	Bowers No. 1	Pa.	A	87
Bowman Coal Co.	Leechburg Pa.	Bowman	Pa.	A	347
Bradford Coal Co.	Bigler Pa.	Cooper Smokeless No. 1	Pa.	A	61
Bradford Coal Co.	Bigler Pa.	Militant Smokeless No. 1	Pa.	A	60
Bradford Coal Co.	Bigler Pa.	Shannon Smokeless No. 1	Pa.	A	67
Braughler & Dinger	New Bethlehem Pa.	Wallwork No. 1	Pa.	A	385
Brettell Coal Co.	610 Commercial St., Mingo Jct. O.	Cool Spring	O.	B	9
Bridgeview Coal Co.	97 East Main St., Uniontown Pa.	Donald No. 2	Pa.	A	274
Brockway Fuel Co.	Brockway Pa.	Frances-Leo	Pa.	A	401

Commercial reproduction prohibited
Downloaded from http://PRR.Railfan.net/documents
Scanned by Rob Schoenberg, ©2010

ALPHABETICAL LIST OF OPERATORS OF BITUMINOUS COAL MINES ON THE PENNSYLVANIA RAILROAD AND LATERAL LINES

OPERATOR	P. O. ADDRESS	MINE	STATE	SECTION	INDEX No.
Brown Inc., E. M.	Clearfield Pa.	Young No. 1	Pa.	A	65
Bruns Coal Co.	Lind Arcade, Zanesville O.	Commander	O.	B	49
Bruns Coal Co.	Lind Arcade, Zanesville O.	Ironsport	O.	B	48
Buckeye Coal Co.	Stambaugh Bldg., Youngstown O.	Buckeye	Pa.	B	23
Buckeye Coal Co.	Stambaugh Bldg., Youngstown O.	Nemacolin	Pa.	A	330
Burichin Coal Co.	Dunlo Pa.	Burichin	Pa.	A	186
Burkhart Coal Co.	Cresson Pa.	Burkhart	Pa.	A	74
Burkhart Coal Co.	Cresson Pa.	Plunket No. 1	Pa.	A	73
Butler Junction Coal Co.	Leechburg Pa.	Butler Junction	Pa.	A	363
Butterworth Fuel Co.	Barnesboro Pa.	Cymbria	Pa.	A	129
C. H. & R. Coal Co.	Rimersburg Pa.	Fenton No. 2	Pa.	A	374
Cadiz Mining Co.	Cadiz O.	Cadiz	O.	B	40
Callahan Coal Co.	Reynoldsville Pa.	Callahan	Pa.	A	390
Caltagrone, Paul	Fuller Pa.	Caltagrone	Pa.	A	388
Cambria-Clearfield Mining Co. (Peale, Peacock & Kerr, Inc.)	St. Benedict Pa.	Springfield No. 6	Pa.	A	101
Cambria Smokeless Coal Co. (Imperial Coal Corp.)	Johnstown Pa.	Cambria Smokeless No. 1	Pa.	A	85
Cambria Smokeless Coal Co. (Imperial Coal Corp.)	Johnstown Pa.	Cambria Smokeless No. 1-D	Pa.	A	84
Campbell, Chas. E.	Bridgeville Pa.	Maude	Pa.	B	25
Capizzi Coal Co.	Indiana Pa.	Joseph No. 1	Pa.	A	137
Carlin, Inc., R. S.	Snow Shoe Pa.	Lehigh Valley No. 28	Pa.	A	1
Caro Coal Co.	Point Marion Pa.	Camp Run	Pa.	A	286
Carroll, J. R.	Philadelphia Road O.	Meechan	O.	B	44
Cassella Coal Co.	Box 405, Apollo Pa.	Cassella	Pa.	A	350
Cherry Hill Coal Co.	Morgantown W. Va.	Lucille No. 2	W. Va.	A	306
Cherry Run Coal Mining Co.	Snow Shoe Pa.	Cherry Run No. 4	Pa.	A	3
Chest Coal Co.	Ramey Pa.	McPherson	Pa.	A	103
Chest Coal Co.	Ramey Pa.	Superior No. 1	Pa.	A	109
Chest Creek Coal Co.	Osceola Mills Pa.	Chest Creek No. 1	Pa.	A	94
Chest Creek Coal Co.	Osceola Mills Pa.	Miller Run No. 7	Pa.	A	95
Christopher Coal Co.	Box 100, Osage W. Va.	Arkwright	W. Va.	A	298
Christopher Coal Co.	Box 100, Osage W. Va.	Booth No. 6	W. Va.	A	315
Christopher Coal Co.	Box 100, Osage W. Va.	Brock No. 4	W. Va.	A	297
Christopher Coal Co.	Box 100, Osage W. Va.	Pursglove No. 8	W. Va.	A	295
Christopher Coal Co.	Box 100, Osage W. Va.	Pursglove No. 15	W. Va.	A	294
Clark Mineral Coal Co.	Hastings Pa.	Lanark No. 1	Pa.	A	100
Clean Coal Co.	Bellaire O.	Carnegie	O.	B	33
Clearfield Bituminous Coal Co.	Indiana Pa.	Barr Slope	Pa.	A	145
Clearfield Bituminous Coal Co.	Indiana Pa.	Clymer No. 3	Pa.	A	143
Clyde Coal Co.	Philipsburg Pa.	Clyde No. 28	Pa.	A	29
Clyde Coal Co.	Philipsburg Pa.	Ramey No. 1	Pa.	A	16
Coleman & Co. (Ebensburg Coal Co.)	123 So. Broad St., Philadelphia Pa.	Ebensburg No. 1	Pa.	A	160
Commercial Coal Mining Co. of Twin Rocks	Twin Rocks Pa.	McFadden Dock	Pa.	A	148
Conemaugh Mining Co.	12800 Shaker Blvd., Cleveland O.	Conemaugh	Pa.	A	236
Conrad Coal Co.	Saltsburg Pa.	Conrad	Pa.	A	349
Consolidation Coal Co. (W. Va.)	Fairmont W. Va.	Consolidation No. 93	W. Va.	A	319
Constantino, Jos.	1012 Graham Ave., Windber Pa.	Constantino	Pa.	A	216
Cortright Coal Co. (Hastings Fuel Co.)	12 So. 12th St., Philadelphia Pa.	Hastings No. 1	Pa.	A	96
Covert & Hagerty	Coalport Pa.	Oakland No. 3	Pa.	A	86
Crago Coal Co.	Philipsburg Pa.	Randolph No. 3	Pa.	A	146
Cravotta, J. E.	14 South Keesey St., York Pa.	Penn No. 3	Pa.	A	421
Creekside Coal Co.	Clearfield Pa.	Creekside	Pa.	A	45
Creighton Coal & Coke Co.	Johnstown Pa.	Virginian No. 14	Pa.	A	166
Crucible Fuel Co.	Oliver Bldg., Pittsburgh Pa.	Crucible	Pa.	A	329
D. & S. Coal Co.	R. D. No. 1, Penn Run Pa.	D. & S.	Pa.	A	161
D-11 Coal Co.	Hastings Pa.	Meegan No. 1	Pa.	A	155
Dahlin Brothers	Houtzdale Pa.	Bear Run	Pa.	A	11
Dalton Run Coal Co.	Hillsboro Pa.	Dalton Run No. 2	Pa.	A	212
Dambacher, J. R.	Ridgeway Pa.	Bernadine No. 1	Pa.	A	399
Davidson, J. J.	Black Lick Pa.	Bennett No. 1	Pa.	A	167
Davies Coal Co.	Morgantown W. Va.	Airport	W. Va.	A	304
Deal & Lantzy Coal Co.	Boswell Pa.	Deal & Lantzy	Pa.	A	231
Dean Coal Co.	Ramey Pa.	King No. 1	Pa.	A	80
Dean Coal Co.	Ramey Pa.	King No. 1	Pa.	A	27

ALPHABETICAL LIST OF OPERATORS OF BITUMINOUS COAL MINES ON THE PENNSYLVANIA RAILROAD AND LATERAL LINES

OPERATOR	P. O. ADDRESS	MINE	STATE	SECTION	INDEX No.
Dean Coal Co.	Ramey Pa.	Mountain Top	Pa.	A	31
Delano Coal Co. (Vinton Coal & Coke Co.)	570 Lexington Ave., New York N. Y.	Vinton No. 6	Pa.	A	153
Delmont Fuel Co.	Coulter Building, Greensburg Pa.	Delmont No. 10	Pa.	A	247
De Romo Coal Co., John A.	Houtzdale Pa.	De Romo	Pa.	A	24
Derringer Fuel Co.	Spangler Pa.	Woodland No. 2	Pa.	A	132
Dexter-Carpenter (Leland Coal Mining Co.)	32 Broadway, New York N. Y.	Leland No. 10	Pa.	A	33
Dubena Coal Co.	378 Main St., Follansbee W. Va.	Dubena	W. Va.	B	8
Du Bois Coal Mining Co.	Brookville Pa.	Du Bois No. 3 (Elba)	Pa.	A	408
Dugan Coal Co., James F.	Osceola Mills Pa.	Du Shan No. 3	Pa.	A	8
Duquesne Light Co.	Pittsburgh Pa.	Harwick	Pa.	A	365
Dutch Hill Coal Co.	Kittanning Pa.	Dutch Hill	Pa.	A	372
Eagle Coal Co.	Greensburg Pa.	Atlantic No. 2	Pa.	A	238
East Windber Coal Co.	Johnstown Pa.	East Windber No. 4	Pa.	A	229
Eastern Gas & Fuel Assoc. (Coal Division)	Koppers Bldg., Pittsburgh Pa.	Federal	W. Va.	A	322
Eastern Gas & Fuel Assoc. (Coal Division)	Koppers Bldg., Pittsburgh Pa.	Sonman Slope	Pa.	A	171
Ebensburg Coal Co. (Coleman & Co.)	123 So. Broad St., Phila. Pa.	Ebensburg No. 1	Pa.	A	160
Elizabeth Coal Co.	Box 954, Morgantown W. Va.	Eldridge No. 1	W. Va.	A	312
Elizabeth Coal Co.	Box 954, Morgantown W. Va.	Eldridge No. 2	W. Va.	A	299
Elizabeth Coal Co.	Box 954, Morgantown W. Va.	Eldridge No. 3	W. Va.	A	292
Ella Coal Co.	Greensburg Pa.	Ella	Pa.	A	245
Elliot Coal Mining Co.	Philipsburg Pa.	Coaldale No. 3	Pa.	A	51
Elliot Coal Mining Co.	Philipsburg Pa.	Copelin	Pa.	A	53
Elliot Coal Mining Co.	Philipsburg Pa.	Curtin Nos. 1 & 2 (Penn No. 7)	Pa.	A	5
Elliot Coal Mining Co.	Philipsburg Pa.	Elliot	Pa.	A	47
Elliot Coal Mining Co.	Philipsburg Pa.	Elliot No. 4	Pa.	A	42
Elliot Coal Mining Co.	Philipsburg Pa.	Graham	Pa.	A	58
Elliot Coal Mining Co.	Philipsburg Pa.	Hill No. 1	Pa.	A	6
Elliot Coal Mining Co.	Philipsburg Pa.	Irvona No. 1	Pa.	A	82
Elliot Coal Mining Co.	Philipsburg Pa.	Penn No. 9	Pa.	A	7
Elliot Coal Mining Co.	Philipsburg Pa.	Riley No. 1	Pa.	A	4
Elliot Coal Mining Co.	Philipsburg Pa.	Viola No. 1	Pa.	A	28
Emerald Coal & Coke Co.	Grant Bldg., Pittsburgh Pa.	Emerald No. 1	Pa.	A	328
Emerald Coal & Coke Co.	Grant Bldg., Pittsburgh Pa.	Emerald No. 2	Pa.	A	326
Enoco Collieries Inc.	Indianapolis Ind.	Enoco	Ind.	C	10
Enrico Coal Co.	Box 2188, Morgantown W. Va.	Stewart	W. Va.	A	293
Enrico-Deprospero Coal Co.	Box 2188, Morgantown W. Va.	Robinson Run	W. Va.	A	291
Estep Coal Co.	Central City Pa.	Estep No. 1	Pa.	A	222
Estep Coal Co.	Central City Pa.	Estep No. 2	Pa.	A	221
Eyerly, Albert J.	Philipsburg Pa.	Beaver	Pa.	A	49
Fleck Bros. Coal Co.	Carnegie Pa.	Fleck	Pa.	B	24
Fort Mason Coal Mining Co.	Masontown Pa.	Fort	Pa.	A	272
Fox Coal Co.	Box 353, Morgantown W. Va.	Fox	W. Va.	A	310
Freedom Coal Co.	Flinton Pa.	Colonial No. 6	Pa.	A	81
Friel Coal Mining Co.	Box 421, Indiana Pa.	Friel No. 6	Pa.	A	237
General Coal Co. (Westmoreland Coal Co.)	Fidelity-Phila. Trust Bldg., Phila. Pa.	Hutchinson	Pa.	A	248
George, A.	Masontown Pa.	Sunshine No. 2	Pa.	A	276
Glass Run Coal Co.	P. O. Box 115, Wilson Sta., Clairton Pa.	Alice No. 1	Pa.	A	420
Glen Brooke Coal Co.	Box 560, Cove Sta., Weirton W. Va.	Half Moon	W. Va.	B	29
Gordon Coal Co., J.	Indiana Pa.	Virginian No. 15	Pa.	A	163
Graceton Inc., Coal Mining Co. of	Graceton Pa.	Graceton No. 3	Pa.	A	338
Green Glen Corp.	Du Bois Pa.	Clear Run	Pa.	A	395
Greensburg-Connellsville Coal & Coke Co.	Union Trust Bldg., Pittsburgh Pa.	Francis	Pa.	B	27
Gregg & Riddle	Burnside Pa.	Gregg & Riddle	Pa.	A	112
Grubbs Construction Co.	Karns City Pa.	Kincaid	Pa.	A	415
Gulbranson, W. O.	Houtzdale Pa.	Houtzdale	Pa.	A	23
Gulbranson, W. O.	Houtzdale Pa.	Leland No. 1	Pa.	A	30
Guseman Bros. Coal Co.	113 Main St., Uniontown Pa.	Guseman Works	Pa.	A	334

**ALPHABETICAL LIST OF OPERATORS OF BITUMINOUS COAL MINES ON
THE PENNSYLVANIA RAILROAD AND LATERAL LINES**

OPERATOR	P. O. ADDRESS	MINE	STATE	SECTION	INDEX No.
H. & H. Coal Co.	Dixonville Pa.	Commodore	Pa.	A	135
H. & H. Coal Co.	Dixonville Pa.	Fisher No. 1	Pa.	A	134
Hall Coal Co.	Morgantown W. Va.	Keener-Baker	W. Va.	A	303
Hall & Son, J. M.	Delmont Pa.	Junior No. 4	Pa.	A	240
Hamilton & Trenner Co.	Route No. 6, Cambridge O.	Walnut Hill	O.	B	58
Harchak & Lucas	Houtzdale Pa.	Cortland	Pa.	A	13
Harchak & Lucas	Houtzdale Pa.	Mountain Branch	Pa.	A	12
Harcliff Coal Co.	Oliver Bldg., Pittsburgh Pa.	Harcliff No. 1	Pa.	A	417
Harmar Coal Co.	Harmarville Pa.	Oakmont	Pa.	A	368
Harmar Coal Co.	Harmarville Pa.	Harmar	Pa.	A	364
Harmar Creek Coal Co.	1st National Bank Bldg., Pittsburgh Pa.	Florence	Pa.	B	26
Hastings Fuel Co. (Cortright Coal Co.)	12 So. 12th St., Phila. Pa.	Hastings No. 1	Pa.	A	96
Haws Refractories	407 Main St., Johnstown Pa.	Shaft	Pa.	A	234
Heffelfinger Coal Co.	Cowansville Pa.	Heffelfinger	Pa.	A	418
Henrietta Coal Mining Co.	Dunlo Pa.	Henrietta	Pa.	A	190
Heshbon Coal Co.	Johnstown Pa.	Heshbon No. 2	Pa.	A	165
Hess Coal Co.	Dixonville Pa.	Hess No. 2	Pa.	A	147
Hillcrest Mng. Co.	Foxburg Pa.	Hillcrest	Pa.	A	373
Hillman & Sons Co., J. H.	Grant Bldg., Pittsburgh Pa.	Black Diamond	Pa.	A	259
Hillman & Sons Co., J. H.	Grant Bldg., Pittsburgh Pa.	Clyde No. 2	Pa.	A	324
Hillman & Sons Co., J. H.	Grant Bldg., Pittsburgh Pa.	Poland No. 3	Pa.	A	279
Hillman & Sons Co., J. H.	Grant Bldg., Pittsburgh Pa.	Poland No. 4	Pa.	A	282
Hillman & Sons Co., J. H.	Grant Bldg., Pittsburgh Pa.	Poland No. 5	Pa.	A	283
Hirst Coal Co., J. M.	Salineville O.	Sterling	O.	B	53
Hochman Coal Co.	Lisbon O.	Pitsy	O.	B	51
Hoffer, Fred	Philipsburg Pa.	Bond Hill	Pa.	A	52
Howard Coal Co.	Philipsburg Pa.	Howard No. 6	Pa.	A	54
Hritz, Geo.	Windber Pa.	Hritz No. 1	Pa.	A	218
Hudec Coll. Co., Inc.	Elton Road, R. D. No. 3, Johnstown Pa.	Lloydell No. 2	Pa.	A	189
Hughes & Co., C. A.	Box 28, Cresson Pa.	Lilly No. 3	Pa.	A	170
Hughes & Co., C. A.	Box 28, Cresson Pa.	Lilly No. 8	Pa.	A	76
Imperial Cardiff Coal Co. (Imperial Coal Corp.)	Johnstown Pa.	Cardiff No. 1 (P. R. R.)	Pa.	A	150
Imperial Cardiff Coal Co. (Imperial Coal Corp.)	Johnstown Pa.	Cardiff No. 1 (C. & I.)	Pa.	A	159
Imperial Coal Corp. (Cambria Smokeless Coal Co.)	Johnstown Pa.	Cambria Smokeless No. 1	Pa.	A	85
Imperial Coal Corp. (Cambria Smokeless Coal Co.)	Johnstown Pa.	Cambria Smokeless No. 1-D	Pa.	A	84
Imperial Coal Corp. (Imperial Cardiff Coal Co.)	Johnstown Pa.	Cardiff No. 1 (P. R. R.)	Pa.	A	150
Imperial Coal Corp. (Imperial Cardiff Coal Co.)	Johnstown Pa.	Cardiff No. 1 (C. & I.)	Pa.	A	159
Imperial Coal Corp.	Johnstown Pa.	Diamond Smokeless Nos. 1 & 2	Pa.	A	235
Imperial Coal Corp.	Johnstown Pa.	Imperial No. 10	Pa.	A	224
Imperial Keystone Coal Co.	Johnstown Pa.	Keystone	Pa.	A	141
Iseman Bros.	New Bethlehem Pa.	Iseman No. 2	Pa.	A	384
Island Coal Co.	Uniontown Pa.	Gibson	Pa.	A	254
Ivywood Coal Co.	Butler Pa.	Dew No. 1	Pa.	B	22
J. & J. Coal Equipment Co.	Signal O.	Signal	O.	B	55
Jackson Hill Coal Co. (J. U. McFadden)	Ebensburg Pa.	Shuman Run Dock	Pa.	A	152
James Coal Co.	Kittanning Pa.	Glenside No. 2	Pa.	A	136
Jeff Mining Co.	Presto Pa.	Presto	Pa.	B	20
Jem Coal Co.	306 North Main St., Masontown Pa.	Eagle No. 1	Pa.	A	275
Johnstown Coal & Coke Co.	U. S. National Bank Bldg., Johnstown Pa.	Cortright No. 1	Pa.	A	193
Johnstown Coal & Coke Co.	U. S. National Bank Bldg., Johnstown Pa.	Logan No. 3	Pa.	A	192
Johnstown Coal & Coke Co.	U. S. National Bank Bldg., Johnstown Pa.	Logan No. 4	Pa.	A	194
Johnstown Coal & Coke Co.	U. S. National Bank Bldg., Johnstown Pa.	Portage No. 2	Pa.	A	173
Johnstown Coal & Coke Co.	U. S. National Bank Bldg., Johnstown Pa.	Portage No. 4	Pa.	A	172
Johnstown Coal & Coke Co.	U. S. National Bank Bldg., Johnstown Pa.	Portage No. 10	Pa.	A	174
Jones & Laughlin Steel Corp.	California Pa.	Shannopin	Pa.	A	284

ALPHABETICAL LIST OF OPERATORS OF BITUMINOUS COAL MINES ON THE PENNSYLVANIA RAILROAD AND LATERAL LINES

OPERATOR	P. O. ADDRESS	MINE	STATE	SECTION	INDEX No.
Jones & Laughlin Steel Corp.	California	Pa. Vesta Coal Preparation Plant	Pa.	A	268
Jones & Laughlin Steel Corp.	California	Pa. Vesta Nos. 4 & 5	Pa.	A	260
Jordan Coal Co.	Philipsburg	Pa. McCartney No. 3 (Jordan 1)	Pa.	A	44
Jordan Coal Co.	Philipsburg	Pa. McCartney No. 4 (Jordan 2)	Pa.	A	46
Kann & Gutsie	R. D. No. 2, Punxsutawney	Pa. Kann No. 4	Pa.	A	114
Kimmel Coal Co.	Shelocta	Pa. Dutch Run	Pa.	A	343
Kish Coal Co.	Powhatan	O. Kish	O.	B	36
Kittanning Coal Co.	Osceola Mills	Pa. Stanley	Pa.	A	15
Klink Coal Co.	Point Marion	Pa. Eleanor	W. Va.	A	317
Knox Run Coal Co.	Snow Shoe	Pa. Knox Run No. 8	Pa.	A	2
Konya Coal Co.	Rivesville	W. Va. Byrne	W. Va.	A	320
Kristianson & Johnson	Philipsburg	Pa. Guival No. 1	Pa.	A	57
Krolick Coal Co.	Dixonville	Pa. Krolic No. 1	Pa.	A	342
L. & W. Coal Co.	7 Woodlawn Ave., Uniontown	Pa. Martha	W. Va.	A	302
L. & W. Coal Co.	7 Woodlawn Ave., Uniontown	Pa. Mason Dixon No. 1	W. Va.	A	307
Lake Lynn Fuel Co.	Morgantown	W. Va. Amore	Pa.	A	278
Lake Lynn Fuel Co.	Morgantown	W. Va. Dilliner	Pa.	A	285
Lake Lynn Fuel Co.	Morgantown	W. Va. Lynn	W. Va.	A	300
Lake Lynn Fuel Co.	Morgantown	W. Va. New Geneva	Pa.	A	277
Lampkie Brothers	Glen Campbell	Pa. Lampkie No. 1	Pa.	A	108
Last Chance Coal Co.	Emich	Pa. Spangler No. 3	Pa.	A	130
Leamer Coal Co.	Dunlo	Pa. Leamer No. 1	Pa.	A	191
Leckrone Coal & Coke Co.	McClellandtown	Pa. Puritan No. 1	Pa.	A	335
Leechburg Mng. Co.	Leechburg	Pa. Foster Nos. 4 and 5	Pa.	A	356
Leland Coal Mining Co. (Dexter-Carpenter)	32 Broadway, New York	N. Y. Leland No. 10	Pa.	A	33
Lick Run Coal Co.	Lloydell	Pa. Lick Run	Pa.	A	195
Lindsey Coal Mining Co.	Punxsutawney	Pa. Lindsey No. 8	Pa.	A	119
Litten, I. L.	Clearfield	Pa. Young No. 2	Pa.	A	64
Locksley Fuel Corp.	Box 847, Morgantown	W. Va. Christopher No. 5	W. Va.	A	314
Loyal Hanna Coal & Coke Co.	1100 Commercial Trust Bldg., Philadelphia	Pa. Loyal Hanna No. 6	Pa.	A	205
Lumaghi Coal Co.	St. Louis	Mo. Lumaghi Nos. 2 and 4	Ill.	C	6
Lutz Coal Co.	Clearfield	Pa. Burnsworth	Pa.	A	62
Lutz Coal Co.	Clearfield	Pa. Lutz	Pa.	A	63
McClure Coal Co.	Reynoldsville	Pa. McClure	Pa.	A	392
McCombie Coal Co.	Spangler	Pa. Miller Run No. 5	Pa.	A	124
McCormick Coal Co.	Barnesboro	Pa. Delta No. 2	Pa.	A	131
McFadden, Fred (Black Lick Coal Mining Co.)	Ebensburg	Pa. Commercial No. 5	Pa.	A	149
McFadden, J. U.	Ebensburg	Pa. Mardon No. 4	Pa.	A	154
McFadden, J. U. (Jackson Hill Coal Co.)	Ebensburg	Pa. Shuman Run Dock	Pa.	A	152
McIntosh Coal Co.	Du Bois	Pa. McIntosh No. 2	Pa.	A	394
McLain Coats, R. H.	Box 663, Morgantown	W. Va. Ellis	W. Va.	A	311
McNutt Coal Co., H. M.	P. O. Box 8, Rimersburg	Pa. Fox	Pa.	A	375
Mac Coal Co.	Sligo	Pa. Mac No. 1	Pa.	A	376
Mahaffey, Mrs. F. C.	Mahaffey	Pa. Mahaffey No. 1	Pa.	A	105
Maldenack Coal Co.	P. O. Box 31, Hunker	Pa. Susan	Pa.	A	249
Marco Coal Co.	Box 457, Apollo	Pa. Marco	Pa.	A	352
Marshall Mining Co.	512 Union Bank Bldg., Youngstown	O. Willow Crest	O.	B	54
Marucci, C. B.	53 Connellsville St., Uniontown	Pa. South Union No. 1	Pa.	A	264
Mateer Coal Co.	446 Canal St., Leechburg	Pa. Mateer	Pa.	A	351
Mathies Coal Co.	Library	Pa. Mathies	Pa.	A	253
Matthews, John H.	Grampian	Pa. Matthews No. 7	Pa.	A	68
Maumee Collieries Inc.	Terre Haute	Ind. Airline No. 32	Ind.	C	8
Maumee Collieries Inc.	Terre Haute	Ind. Sullivan No. 27	Ind.	C	7
Menallen Coke Co.	P. O. Box 42, New Salem	Pa. Footedale	Pa.	A	331
Meyer Brothers	Philipsburg	Pa. Meyer No. 1	Pa.	A	9
Middle Pennsylvania Coal Corp.	Madera	Pa. Alexander	Pa.	A	38
Middle Pennsylvania Coal Corp.	Madera	Pa. Cammos No. 1	Pa.	A	88
Middle Pennsylvania Coal Corp.	Madera	Pa. Corona	Pa.	A	41
Middle Pennsylvania Coal Corp.	Madera	Pa. Mid-Penn Nos. 4 and 5	Pa.	A	37

ALPHABETICAL LIST OF OPERATORS OF BITUMINOUS COAL MINES ON THE PENNSYLVANIA RAILROAD AND LATERAL LINES

OPERATOR	P. O. ADDRESS	MINE	STATE	SECTION	INDEX No.
Midway Coal Co.	McCartney Pa.	Midway No. 1	Pa.	A	43
Milchak Coal Co.	Hastings Pa.	Lee Hollow No. 3	Pa.	A	104
Minns Brothers	Du Bois Pa.	Minns	Pa.	A	393
Mon. Valley Coal & Lumber Co.	Box 676, Morgantown W. Va.	Rosedale No. 7	Pa.	A	281
Moore & Son, W. G.	Philipsburg Pa.	Moore No. 5	Pa.	A	14
Moore & Son, W. G.	Philipsburg Pa.	Shirley No. 1	Pa.	A	21
Moore & Son, W. G.	Philipsburg Pa.	Shirley No. 2	Pa.	A	36
Moore & Son, W. J.	R. F. D. No. 3, Warren O.	Moore	O.	B	52
Morrisdale Coal Mining Co.	Fidelity-Phila. Trust Bldg., Philadelphia Pa.	Clymer No. 2	Pa.	A	142
Morrisdale Coal Mining Co.	Fidelity-Phila. Trust Bldg., Philadelphia Pa.	Mapleton No. 5	Pa.	A	50
Moshannon Smithing Coal Corp.	P. O. Box 178, Ramey Pa.	Glenmar No. 1	Pa.	A	32
Mountainside Coal Co.	Windber Pa.	Mountainside	Pa.	A	215
Mountz & Co., S. J.	Smith Mills Pa.	Viola No. 3	Pa.	A	26
National Hocking Coals, Inc.	Box 145, Roseville O.	Golden Oak	O.	B	47
Nassar Coal Co.	Star Jct. Pa.	Nassar	Pa.	A	250
New Bethlehem Contr. Co.	New Bethlehem Pa.	Bostonia No. 1	Pa.	A	382
New Shawmut Mng. Co.	St. Marys Pa.	Brandy Camp No. 5	Pa.	A	400
New Shawmut Mng. Co.	St. Marys Pa.	Proctor No. 3	Pa.	A	397
Nixon Run Coal Co.	Martins Ferry O.	Nixon	O.	B	31
North American Coal Corp.	Shaker Square, Shaker Heights O.	Betsy No. 1	O.	B	10
North Cambria Fuel Co.	Patton Pa.	Pine Ridge No. 5	Pa.	A	98
North Star Coal Co.	Bessemer Bldg., Pittsburgh Pa.	Jean No. 1	Pa.	B	12
Norton Co., David Z.	Hanna Bldg., Cleveland O.	Norton No. 3	O.	B	37
Oak Coal Co.	Route 2, Morgantown W. Va.	Gabbert	W. Va.	A	313
Obreza, T.	Windber Pa.	Kryan	Pa.	A	188
Ogden Coal-Iron-Metal Co.	Morgantown W. Va.	Ridge	W. Va.	A	308
Ogletown Coal Co.	Ogletown Pa.	Ogletown	Pa.	A	219
O'Harrach Mng. Co.	Reynoldsville Pa.	O'Harrach	Pa.	A	389
Ontario Mining Co.	Eighty-four Pa.	Ontario	Pa.	A	257
Orchard Coal Co.	Cambridge O.	Orchard	O.	B	56
P. & G. Coal Co.	Holden Pa.	Fisher	Pa.	A	409
P. & G. Coal Co.	Holden Pa.	P. & G.	Pa.	A	407
P. & K., Inc.	Port Allegany Pa.	P. & K.	Pa.	A	404
P. & N. Coal Co.	Punxsutawney Pa.	P. & N. No. 2	Pa.	A	398
P. & N. Coal Co.	Punxsutawney Pa.	P. & N. No. 7	Pa.	A	111
P. & N. Coal Co.	Punxsutawney Pa.	Summit Dock (Arcadia Coal Co.)	Pa.	A	107
Pamco Coal Co.	Columbus O.	Clover Run	Pa.	A	113
Park Coal Co.	Leechburg Pa.	Park	Pa.	A	361
Passmore Coal Co.	Mahaffey Pa.	Randolph No. 2	Pa.	A	144
Patton Clay Mfg. Co.	Patton Pa.	Patton Clay	Pa.	A	93
Pavelco & Pendersen	Barnesboro Pa.	P. P. & K.	Pa.	A	127
Peaker Run Coal Co.	R. F. D., Elba O.	Elba	O.	B	60
Peale, Peacock & Kerr, Inc. (Springfield Coal Corp.)	St. Benedict Pa.	Springfield No. 4	Pa.	A	126
Peale, Peacock & Kerr, Inc. (Cambria-Clearfield Mng. Co.)	St. Benedict Pa.	Springfield No. 6	Pa.	A	101
Peerless Coal Co.	913 Montgomery Ave., Narberth Pa.	Peerage No. 2	Pa.	A	211
Penn Ohio Coal Co.	Dover O.	Pond Hollow	O.	B	38
Pennsylvania Coal Co.	Uniontown Pa.	Hoover No. 1	Pa.	A	333
Pennsylvania Coal Co.	Uniontown Pa.	Hoover No. 2	Pa.	A	332
Pennsylvania Coal & Coke Corp.	30 Pine St., New York N. Y.	Pennsylvania No. 3	Pa.	A	180
Pennsylvania Coal & Coke Corp.	30 Pine St., New York N. Y.	Pennsylvania No. 8	Pa.	A	181
Pennsylvania Coal & Coke Corp.	30 Pine St., New York N. Y.	Pennsylvania No. 22	Pa.	A	133
Penowa Coal Co.	Grant Bldg., Pittsburgh Pa.	Avella Washery	Pa.	B	2
Penowa Coal Co.	Grant Bldg., Pittsburgh Pa.	Sasso No. 1	W. Va.	B	7
Peters Creek Coal Co.	Grant Bldg., Pittsburgh Pa.	Piney Fork	Pa.	A	251
Pickens Mather	2000 Union Commerce Bldg., Cleveland O.	Mather	Pa.	A	327
Pine Run Co.	Leechburg Pa.	Lewis	Pa.	A	360
Pine Township Coal Co.	Heilwood Pa.	Pine No. 1	Pa.	A	162

ALPHABETICAL LIST OF OPERATORS OF BITUMINOUS COAL MINES ON THE PENNSYLVANIA RAILROAD AND LATERAL LINES

OPERATOR	P. O. ADDRESS	MINE	STATE	SECTION	INDEX No.
Pine Township Coal Co.	Heilwood Pa.	Pine No. 2	Pa.	A	139
Pinto, John	Osceola Mills Pa.	Imperial No. 11	Pa.	A	20
Piper & Co., W. H.	Lilly Pa.	Sonman No. 2	Pa.	A	169
Pittsburgh Coal Co.	Library Pa.	Pittsburgh Coal Co. No. 157 (Russell No. 1)	Pa.	B	14
Pittsburgh Coal Co.	Library Pa.	Pittsburgh Coal Co. No. 158	Pa.	B	18
Pittsburgh Coal Co.	Library Pa.	Renton No. 3	Pa.	A	366
Pittsburgh Coal Co.	Library Pa.	Pittsburgh Coal Co. No. 160 (Champion No. 1 Cleaning Plant)	Pa.	B	15
Pittsburgh Coal Co.	Library Pa.	Pittsburgh Coal Co. No. 164	Pa.	B	19
Pittsburgh Coal Co.	Library Pa.	Pittsburgh Coal Co. No. 167	Pa.	B	17
Pittsburgh Consolidation Coal Co. (Hanna Division)	Leader Bldg., Cleveland O.	Georgetown (Pittsburgh Consolidation Coal Co. Cleaning and Preparation Plant)	O.	B	41
Pittsburgh Consolidation Coal Co.	Koppers Bldg., Pittsburgh Pa.	Jamison No. 21	Pa.	A	239
Pittsburgh Consolidation Coal Co.	Koppers Bldg., Pittsburgh Pa.	Loveridge Mine (Fairview)	W. Va.	A	323
Pittsburgh & Fairmont Coal Co.	First National Bank Bldg., Pittsburgh Pa.	Rich Hill	Pa.	A	422
Polen Coal Co.	Box 248, Hopedale O.	Hopedale	O.	B	11
Poole Coal Co.	Delmont Pa.	Poole No. 3	Pa.	A	241
Portage-Kittanning Coal Co.	Portage Pa.	Martindale	Pa.	A	178
Portersville Coal Co.	Clarion Pa.	Portersville	Pa.	B	21
Powell Coal Co.	R. D. No. 2, Kittanning Pa.	Decker No. 2	Pa.	A	369
Powell Coal Co., C. E.	Blandburg Pa.	Bellsena	Pa.	A	40
Powell Coal Co., C. E.	Blandburg Pa.	Bland No. 4	Pa.	A	78
Powell Coal Co., C. E.	Blandburg Pa.	Powell No. 1	Pa.	A	75
Powell Coal Co., C. E.	Blandburg Pa.	Powell No. 3	Pa.	A	91
Powell Coal Co., C. E.	Blandburg Pa.	Powell No. 5	Pa.	A	71
Powell Coal Co., C. E.	Blandburg Pa.	Powell No. 6	Pa.	A	92
Powell Coal Co., C. E.	Blandburg Pa.	Sterling No. 3	Pa.	A	77
Powhatan Mining Co.	12800 Shaker Blvd., Cleveland O.	Betsy No. 2	O.	B	43
Powhatan Mining Co.	12800 Shaker Blvd., Cleveland O.	Fulton No. 3	O.	B	39
Powhatan Mining Co.	12800 Shaker Blvd., Cleveland O.	Powhatan Nos. 1 and 2	O.	B	35
Powhatan Mining Co.	12800 Shaker Blvd., Cleveland O.	Powhatan No. 3	O.	B	34
Press Coal Co.	Barnesboro Pa.	Thermal No. 7	Pa.	A	128
Preston By-Product Coal Co.	Box 828, Morgantown W. Va.	Indian	W. Va.	A	318
Prospect Coal Co.	Portage Pa.	Prospect No. 1	Pa.	A	176
Pursglove Coal Sales, W. L.	Morgantown W. Va.	Virginia	W. Va.	A	309
Quality Coal Co.	Terre Haute Ind.	Quality No. 2	Ind.	C	1
R. & F. Coal Co.	Box 282, Cadiz O.	Healy No. 1	O.	B	42
Ragalini, Joseph	Homer City Pa.	Ragalini	Pa.	A	340
Raines, George M.	Philipsburg Pa.	Garland	Pa.	A	56
Raines, George M.	Philipsburg Pa.	Loch Lomond	Pa.	A	55
Red Top Coal Co.	Spangler Pa.	Red Top	Pa.	A	97
Reeves, Major L.	R. D. No. 2, Chicora Pa.	Mahood No. 4	Pa.	A	412
Reitz Coal Co.	Windber Pa.	Reitz No. 3	Pa.	A	208
Reitz Coal Co.	Windber Pa.	Reitz No. 4	Pa.	A	207
Reitz Coal Co.	Windber Pa.	Reitz No. 5	Pa.	A	198
Republic Steel Corp.	Republic Building, Cleveland O.	Clyde No. 1	Pa.	A	265
Republic Steel Corp.	Republic Building, Cleveland O.	Clyde No. 3	Pa.	A	325
Republic Steel Corp.	Republic Building, Cleveland O.	Newfield	Pa.	A	367
Rice Brothers Coal Co.	Philipsburg Pa.	Banner	Pa.	A	10
Rich Hill Coal Mining Corp.	Cresson Pa.	Rich Hill Nos. 1 and 2	Pa.	A	99
River Smokeless Coal Co.	Clearfield Pa.	Pine Run No. 1	Pa.	A	83
Rochester & Pittsburgh Coal Co.	Indiana Pa.	Ernest Nos. 1 and 2	Pa.	A	344
Rochester & Pittsburgh Coal Co.	Indiana Pa.	Kent Nos. 1 and 2	Pa.	A	345
Rochester & Pittsburgh Coal Co.	Indiana Pa.	Kent Nos. 3 and 4	Pa.	A	346
Rochester & Pittsburgh Coal Co.	Indiana Pa.	Lucerne	Pa.	A	339
Rochester & Pittsburgh Coal Co.	Indiana Pa.	Watson	Pa.	A	348
Rock Tunnel Coal Co.	Portage Pa.	Rock Tunnel	Pa.	A	177
Rosedale Coal Co.	Morgantown W. Va.	Rosedale No. 1	W. Va.	A	289
Rosedale Coal Co.	Morgantown W. Va.	Rosedale No. 1-S	W. Va.	A	288

ALPHABETICAL LIST OF OPERATORS OF BITUMINOUS COAL MINES ON THE PENNSYLVANIA RAILROAD AND LATERAL LINES

OPERATOR	P. O. ADDRESS	MINE	STATE	SECTION	INDEX No.
Rosedale Coal Co.	Morgantown W. Va.	Rosedale No. 3	W. Va.	A	287
Rowland, Howard	Philipsburg Pa.	Sterling No. 3	Pa.	A	22
Royal Smokeless Coal Co.	Johnstown Pa.	Lens No. 1	Pa.	A	70
Rydesky, John E.	Emporium Pa.	Sterling Run	Pa.	A	403
S. & U. Coal Co.	Box 297, Wyland Pa.	Marchand	Pa.	A	244
Saul, Craig G.	R. D. No. 5, Butler Pa.	Egal	Pa.	A	411
Scott Bros.	Glasgow Pa.	Troxell No. 2	Pa.	A	89
Seanor Coal Corp.	Saltsburg Pa.	Seanor-Loyal	Pa.	A	242
Seckinger Coal Co.	Madera Pa.	Seckinger No. 1	Pa.	A	39
Shaffer, Foster	Windber Pa.	Windber No. 2	Pa.	A	210
Shaffer, Myron	Rummell Pa.	Shaffer-Myron	Pa.	A	220
Shasta Coal Corp.	Box 278, Bicknell Ind.	Shasta	Ind.	C	9
Sherman Co., Jos. F.	Hawthorn Pa.	Sherman No. 2	Pa.	A	386
Sherman Co., Jos. F.	Hawthorn Pa.	Sherman No. 5	Pa.	A	383
Shuster Coal Co.	9th St., Windber Pa.	Shuster	Pa.	A	209
Silhol Coal Co.	Bridgeville Pa.	Silhol	Pa.	B	1
Sloan, Dr. F. C.	Barnsboro Pa.	F. C. Sloan Dock	Pa.	A	120
Smith & Son, W. A.	Glen Campbell Pa.	Smith Nos. 1 and 2	Pa.	A	110
Smith Coal Co.	Brisbin Pa.	Ashland	Pa.	A	18
Smith Estate	Clearfield Pa.	Amesville 30	Pa.	A	25
Snow Hill Coal Corp.	Terre Haute Ind.	Green Valley	Ind.	C	4
Snow Hill Coal Corp.	Terre Haute Ind.	Wabash	Ind.	C	5
Snyder Coal Co.	107 Glenburn Drive, Pittsburgh Pa.	Elrama	Pa.	A	252
South Union Coal Co.	Edna W. Va.	South Union No. 11	W. Va.	A	316
Speer Coal Corp., Clyde E.	Koppers Bldg., Pittsburgh Pa.	Pea Vine	Pa.	B	4
Speer Coal Corp., Clyde E.	Koppers Bldg., Pittsburgh Pa.	Speer No. 4	Pa.	B	5
Springfield Coal Corp. (Peale, Peacock & Kerr, Inc.)	St. Benedict Pa.	Springfield No. 4	Pa.	A	126
Stahlman Coal Co.	Corsica Pa.	Stahlman No. 1	Pa.	A	405
Stahlman Coal Co.	Corsica Pa.	Stahlman No. 2	Pa.	A	406
State Line Coal Co.	Marion Ave., Oakdale Pa.	Waverly	Pa.	B	6
Sterling Coal Co.	Elmora Pa.	Sterling No. 1	Pa.	A	123
Sterling Coal Co.	Elmora Pa.	Sterling No. 6	Pa.	A	122
Stickel, H. Clay	Cairnbrook Pa.	Berkey	Pa.	A	206
Stiles Coal Co., G. A.	Tylersburg Pa.	Huey	Pa.	A	378
Stineman Coal & Coke Co.	Suburban Station Bldg., Philadelphia 3 Pa.	Stineman Nos. 1 and 3	Pa.	A	183
Stineman Coal & Coke Co.	Suburban Station Bldg., Philadelphia 3 Pa.	Stineman No. 4	Pa.	A	182
Stineman Coal & Coke Co.	259 Grove Ave., Johnstown Pa.	Stineman No. 12	Pa.	A	226
Stoker Coal Co.	Lloydell Pa.	Penker No 1	Pa.	A	175
Sunbeam Coal Co.	North Washington Pa.	Sunbeam	Pa.	A	413
Sunnyhill Coal Co.	150 East Broad St., Columbus O.	Sunnyhill No. 8	O.	B	50
Taylor Bros.	Hawthorn Pa.	Taylor	Pa.	A	387
Ten X Coal Co.	Roseville O.	Ten X	O.	B	46
Thermal Run Coal Mng. Co.	Windber Pa.	Thermal Nos. 6 & 8	Pa.	A	202
Thompson Coal Co.	Philipsburg Pa.	F. C. M.	Pa.	A	59
Thompson Coal Co.	Blairsville Pa.	Thompson No. 1	Pa.	A	164
Toy, Edwin W.	R. D. No. 3, Kittanning Pa.	Edwin W Toy	Pa.	A	414
Toy Coal Co., P. L.	Box 169, Kittanning Pa.	Toy No. 10	Pa.	A	416
Tri-K Mining Co.	Terre Haute Ind.	Tri-K-Mine	Ind.	C	3
Trone Coal Co.	101 Hillcrest Ave., Johnstown Pa.	Yeager	Pa.	A	225
Trotter Coal Co.	Box 859, Morgantown W. Va.	Bunker	W. Va.	A	296
Underhill Coal Mining Co.	St. Marys Pa.	Tyler No. 14	Pa.	A	396
Union Carbide & Carbon Co. (Electro Metallurgical Div.)	Dexter City O.	Electromet	O.	B	61
United Collieries Co.	Hippodrome Bldg., Cleveland O.	Aurora	Pa.	B	3
United States Steel Corp.	525 Wm. Penn Place, Pittsburgh Pa.	Bridgeport No. 1	Pa.	A	266
United States Steel Corp.	525 Wm. Penn Place, Pittsburgh Pa.	Collier	Pa.	A	336
United States Steel Corp.	525 Wm. Penn Place, Pittsburgh Pa.	Colonial	Pa.	A	261
United States Steel Corp.	525 Wm. Penn Place, Pittsburgh Pa.	Leisenring No. 2	Pa.	A	263

ALPHABETICAL LIST OF OPERATORS OF BITUMINOUS COAL MINES ON THE PENNSYLVANIA RAILROAD AND LATERAL LINES

OPERATOR	P. O. ADDRESS	MINE	STATE	SECTION	INDEX No.
United States Steel Corp.	525 Wm. Penn Place, Pittsburgh . Pa.	Leisenring No. 3	Pa.	A	262
United States Steel Corp.	525 Wm. Penn Place, Pittsburgh . Pa.	Maxwell	Pa.	A	267
United States Steel Corp.	525 Wm. Penn Place, Pittsburgh . Pa.	Palmer	Pa.	A	270
United States Steel Corp.	525 Wm. Penn Place, Pittsburgh . Pa.	Ronco	Pa.	A	271
Valley Camp Coal Co.	Morgantown W. Va.	Maiden	W. Va.	A	290
Valley Coal Co.	Brockway Pa.	Henderson	Pa.	A	410
Valley Coal Co.	Heilwood Pa.	Valley No. 4	Pa.	A	138
Venturini Bros.	Leechburg Pa.	Venturini	Pa.	A	362
Verna Coal Sales, A. F.	Windber Pa.	Superior No. 1	Pa.	A	223
Vinton Coal & Coke Co. (Delano Coal Co.)	570 Lexington Ave., New York . N. Y.	Vinton No. 6	Pa.	A	153
Virginia & Pittsburgh Coal Co.	Fairmont W. Va.	Morgan	W. Va.	A	321
Virginia Mining Co.	Cambridge O.	Carol No. 2	O.	B	59
Wallin Estate, J. H.	Philipsburg Pa.	Henrietta No. 6	Pa.	A	17
Wallwork Coal Co.	Summerville Pa.	Mosgrove	Pa.	A	371
Warroquier Coal Co.	Clearfield Pa.	Warroquier	Pa.	A	66
Webco Coal Co.	Box 2, Hunker Pa.	Webco	Pa.	A	246
Weirton Steel Co.	Isabella Pa.	Isabella Works	Pa.	A	269
Weise Bros.	627 Oliver Bldg., Pittsburgh . Pa.	Morris	Pa.	B	16
Werry Coal Co.	Vineland N. J.	Werry No. 11	Pa.	A	213
Wertz Coal Co., D. G.	Greensburg Pa.	Westport	Pa.	A	402
West Freedom Mng. Co.	4 Glass St., Carnegie Pa.	West Freedom Nos. 1 and 2	Pa.	A	380
Westmoreland Coal Co. (General Coal Co.)	Fidelity Phila.-Trust Bldg., Phila- delphia Pa. }	Hutchinson	Pa.	A	248
West Virginia-Pittsburgh Coal Co.	1031 Main St., Wellsburg W. Va.	Locust Grove	W. Va.	B	28
Whiteley Mining Co.	Mt. Pleasant Pa.	Maple No. 3	Pa.	A	280
Wilkes Coal Co.	Houtzdale Pa.	Imperial Nos. 10 and 12	Pa.	A	19
Williamson, H. D.	Millersburg O.	Williamson	O.	B	63
Wilmore Fuel Co.	Johnstown Pa.	Mack No. 2	Pa.	A	140
Willowbrook Coal Co.	R. F. D. No. 5, Coshocton O.	Willowbrook	O.	B	45
Windber Hi-Grade Coal Co.	Windber Pa.	Wyatt Nos. 1 and 3	Pa.	A	214
Wingert Contracting Co.	Butler Pa.	Lloyd No. 3	Pa.	A	381
Yakubisin Coal Co.	R. D. 6, Box 45, Cambridge O.	Gill	O.	B	57
Yale Mining Co.	Morgantown W. Va.	Provins	W. Va.	A	301
Yobbagy, Joseph E.	Ebensburg Pa.	Lincoln No. 1	Pa.	A	157
Yorkshire Coal Co., Inc.	Madera Pa.	Homestead	Pa.	A	35
Yorkshire Coal Co., Inc.	Madera Pa.	Yorkshire	Pa.	A	34
Youghiogheny & Ohio Coal Co.	Hanna Bldg., Cleveland O.	Dorothy No. 1	O.	B	30
Youghiogheny & Ohio Coal Co.	Hanna Bldg., Cleveland O.	Florence	O.	B	32



**ALPHABETICAL LIST OF BITUMINOUS COAL MINES ON
THE PENNSYLVANIA RAILROAD AND LATERAL LINES**

**PENNSYLVANIA AND WEST VIRGINIA
EAST OF PITTSBURGH**

INDEX No.	MAP A	MINE	STATE	INDEX No.	MAP A	MINE	STATE
243	H-5	Adamsburg	Pa.	363	E-5	Butler Junction	Pa.
304	M-3	Airport	W. Va.	320	M-3	Byrne	W. Va.
38		Alexander	Pa.				
420	H-4	Alice No. 1	Pa.				
419		Alice No. 2	Pa.				
379		Allison No. 12	Pa.	390		Callahan	Pa.
353		Altmire	Pa.	388		Caltagrone	Pa.
25		Amesville 30	Pa.	90	E-11	Cambria Mills No. 2	Pa.
278	L-3	Amore	Pa.	79	E-10	Cambria Mills No. 3	Pa.
377		Amos No. 6	Pa.	85	E-10	Cambria Smokeless No. 1	Pa.
117	C-8	Anita Dock	Pa.	84		Cambria Smokeless No. 1-D	Pa.
118	C-8	Anita No. 1	Pa.	88	E-11	Cammos No. 1	Pa.
341	F-8	Appalcha	Pa.	286	L-3	Camp Run	Pa.
107	D-9	Arcadia Coal Co. (Summit Dock)	Pa.	150	G-9	Cardiff No. 1 (P. R. R.)	Pa.
298	L-3	Arkwright	W. Va.	159	G-9	Cardiff No. 1 (C & I.)	Pa.
203	I-9	Arrow	Pa.	350	F-5	Cassela	Pa.
18	D-12	Ashland	Pa.	354	F-5	Cherry Run	Pa.
238	H-7	Atlantic No. 2	Pa.	3		Cherry Run No. 4	Pa.
				94	E-10	Chest Creek No. 1	Pa.
				314	M-3	Christopher No. 5	W. Va.
				395	B-9	Clear Run	Pa.
217	I-9	"B" Quality No. 8	Pa.	113		Clover Run	Pa.
201	I-9	"B" Quality No. 9	Pa.	265	J-3	Clyde No. 1	Pa.
305	M-3	Baker Ridge Mine	W. Va.	324	J-3	Clyde No. 2	Pa.
273	K-4	Baker Siding, C. H.	Pa.	325	J-3	Clyde No. 3	Pa.
10	D-12	Banner	Pa.	29	E-11	Clyde No. 28	Pa.
115		Barilar	Pa.	142	E-8	Clymer No. 2	Pa.
145	E-8	Barr Slope	Pa.	143	E-8	Clymer No. 3	Pa.
11	D-12	Bear Run	Pa.	51		Coaldale No. 3	Pa.
49		Beaver	Pa.	336	K-4	Collier	Pa.
358	F-5	Beck	Pa.	261	J-4	Colonial	Pa.
199	I-9	Beechnut No. 1	Pa.	81	E-10	Colonial No. 6	Pa.
69		Belfast No. 2	Pa.	149	G-9	Commercial No. 5	Pa.
40		Bellsena	Pa.	135	E-9	Commodore	Pa.
102	D-10	Benjamin No. 3	Pa.	236	G-8	Conemaugh	Pa.
167	G-7	Bennett No. 1	Pa.	349		Conrad	Pa.
168	G-11	Bennington "B"	Pa.	319	M-3	Consolidation No. 93	W. Va.
228	H-9	Bens Creek No. 1	Pa.	216		Constantino	Pa.
206	I-9	Berkey	Pa.	61		Cooper Smokeless No. 1	Pa.
399		Bernadine No. 1	Pa.	53		Copelin	Pa.
255	I-3	Bethlehem No. 51	Pa.	41		Corona	Pa.
258	J-2	Bethlehem No. 58	Pa.	13	D-12	Cortland	Pa.
256	I-3	Bethlehem No. 60	Pa.	193	H-10	Cortright No. 1	Pa.
233	H-9	Bethlehem No. 72	Pa.	45	D-10	Creekside	Pa.
232	H-9	Bethlehem No. 73	Pa.	329	K-3	Crucible	Pa.
230	H-9	Bethlehem No. 74	Pa.	5		Curtin Nos. 1 and 2 (Penn No. 7)	Pa.
204		Bigan Nos. 22 & 23	Pa.	129	E-10	Cymbria	Pa.
48	D-12	Bigelow Run	Pa.			D. & S.	Pa.
227	H-9	Bird No. 3	Pa.	161		Dalton Run No. 2	Pa.
259	I-4	Black Diamond	Pa.	212		Daugherty No. 2	Pa.
78		Bland No. 4	Pa.	337	K-4	Deal & Lantzy	Pa.
359	F-5	Bleriot	Pa.	231		Decca Nos. 2 & 3	Pa.
116		Blose Dock	Pa.	200	I-9	Decker No. 2	Pa.
52	D-12	Bond Hill	Pa.	369	D-5	Delmont No. 10	Pa.
315	M-3	Booth No. 6	W. Va.	247	I-5	Delta No. 2	Pa.
382		Bostonia No. 1	Pa.	131	E-9	De Romo	Pa.
87		Bowers No. 1	Pa.	24		Diamond Smokeless Nos. 1 & 2	Pa.
347	G-6	Bowman	Pa.	235	G-8	Dilliner	Pa.
106		Brady Run Dock	Pa.	285	L-3	Donald No. 2	Pa.
400	A-10	Brandy Camp No. 5	Pa.	274	K-3	Du Bois No. 3 (Elba)	Pa.
266	J-3	Bridgeport No. 1	Pa.	408		Du Shan No. 3	Pa.
297	L-2	Brock No. 4	W. Va.	8	D-12	Dutch Hill	Pa.
296	L-3	Bunker	W. Va.	372	C-5	Dutch Run	Pa.
186	H-10	Burichin	Pa.	343	F-7		
74	F-11	Burkhart	Pa.				
62		Burnsworth	Pa.				

**ALPHABETICAL LIST OF BITUMINOUS COAL MINES ON
THE PENNSYLVANIA RAILROAD AND LATERAL LINES**

**PENNSYLVANIA AND WEST VIRGINIA
EAST OF PITTSBURGH**

INDEX No.	MAP A	MINE	STATE	INDEX No.	MAP A	MINE	STATE
275	K-3	Eagle No. 1	Pa.	333	K-4	Hoover No. 1	Pa.
229		East Windber No. 4	Pa.	332	K-4	Hoover No. 2	Pa.
160	F-9	Ebensburg No. 1	Pa.	23		Houtzdale	Pa.
411	C-3	Egal	Pa.	54		Howard No. 6	Pa.
408		Elba (Du Bois No. 3)	Pa.	218	I-9	Hritz No. 1	Pa.
312	M-3	Eldridge No. 1	W. Va.	378		Huey	Pa.
299	L-3	Eldridge No. 2	W. Va.	248	H-4	Hutchinson	Pa.
292	L-3	Eldridge No. 3	W. Va.				
317	M-3	Eleanor	W. Va.				
245	I-5	Ella	Pa.				
47	D-12	Elliot	Pa.	224	H-9	Imperial No. 10	Pa.
42		Elliot No. 4	Pa.	19	D-12	Imperial Nos. 10 & 12	Pa.
311	M-3	Ellis	W. Va.	20		Imperial No. 11	Pa.
252		Elrama	Pa.	318	M-3	Indian	W. Va.
328	J-3	Emerald No. 1	Pa.	82		Irvona No. 1	Pa.
326	J-3	Emerald No. 2	Pa.	269	J-3	Isabella Works	Pa.
344	E-7	Ernest Nos. 1 & 2	Pa.	384		Iseman No. 2	Pa.
222	I-9	Estep No. 1	Pa.				
221	I-9	Estep No. 2	Pa.				
197	H-9	Eureka No. 37	Pa.				
196	H-9	Eureka No. 40	Pa.				
				239	H-6	Jamison No. 21	Pa.
59		F. C. M.	Pa.	44	D-10	Jordan No. 1 (McCartney No. 3)	Pa.
322	M-2	Federal	W. Va.	46	D-10	Jordan No. 2 (McCartney No. 4)	Pa.
374		Fenton No. 2	Pa.	137	E-8	Joseph No. 1	Pa.
134	E-9	Fisher No. 1	Pa.	357	F-6	June	Pa.
409		Fisher	Pa.	240		Junior No. 4	Pa.
331	K-4	Footedale	Pa.				
272	K-4	Fort	Pa.	114		Kann No. 4	Pa.
356	F-6	Foster Nos. 4 & 5	Pa.	303	M-3	Keener-Baker	W. Va.
375		Fox	Pa.	345	F-7	Kent Nos. 1 & 2	Pa.
310	M-3	Fox	W. Va.	346	F-7	Kent Nos. 3 & 4	Pa.
401		Frances-Leo	Pa.	141	E-8	Keystone	Pa.
237		Friel No. 6	Pa.	415	C-4	Kincaid	Pa.
				27		King No. 1	Pa.
				80		King No. 1	Pa.
				2	C-13	Knox Run No. 8	Pa.
313	M-3	Gabbert	W. Va.	342	F-7	Krolic No. 1	Pa.
56		Garland	Pa.	188	H-10	Kryan	Pa.
370		Garrett Run	Pa.				
254	I-3	Gibson	Pa.				
32	E-11	Glenmar No. 1	Pa.				
136	E-8	Glenmar No. 2	Pa.	108	D-9	Lampkie No. 1	Pa.
338	F-7	Graceton No. 3	Pa.	100		Lanark No. 1	Pa.
58		Graham	Pa.	125	F-9	Lancashire No. 15	Pa.
112		Gregg & Riddle	Pa.	121	F-10	Lancashire No. 20	Pa.
57		Guiwal No. 1	Pa.	72		Laurel Run No. 1	Pa.
334	K-4	Guseman Works	Pa.	191		Leamer No. 1	Pa.
				104	D-10	Lee Hollow No. 3	Pa.
				1		Lehigh Valley No. 28	Pa.
				263	J-5	Leisenring No. 2	Pa.
417		Harcliff No. 1	Pa.	262	J-5	Leisenring No. 3	Pa.
364	F-4	Harmar	Pa.	30	E-11	Leland No. 1	Pa.
365	F-4	Harwick	Pa.	33	E-11	Leland No. 10	Pa.
96	E-10	Hastings No. 1	Pa.	70		Lens No. 1	Pa.
418		Heffelfinger	Pa.	360	F-5	Lewis	Pa.
410		Henderson	Pa.	195	H-10	Lick Run	Pa.
190		Henrietta	Pa.	170	G-10	Lilly No. 3	Pa.
17		Henrietta No. 6	Pa.	76		Lilly No. 8	Pa.
165	G-8	Heshbon No. 2	Pa.	157		Lincoln No. 1	Pa.
147	E-8	Hess No. 2	Pa.	119	C-8	Lindsey No. 8	Pa.
373		Hillcrest	Pa.	381		Lloyd No. 3	Pa.
6		Hill No. 1	Pa.	189	H-10	Lloydell No. 2	Pa.
35	D-11	Homestead	Pa.	55		Loch Lomond	Pa.

**ALPHABETICAL LIST OF BITUMINOUS COAL MINES ON
THE PENNSYLVANIA RAILROAD AND LATERAL LINES**

**PENNSYLVANIA AND WEST VIRGINIA
EAST OF PITTSBURGH**

INDEX No.	MAP A	MINE	STATE	INDEX No.	MAP A	MINE	STATE
192	H-10	Logan No. 3	Pa.	86	E-10	Oakland No. 3	Pa.
194	H-10	Logan No. 4	Pa.	368	F-4	Oakmont	Pa.
323	M-2	Loveridge Mine (Fairview)	W. Va.	219	I-9	Ogletown	Pa.
205	I-9	Loyal Hanna No. 6	Pa.	389		O'Harrach	Pa.
339	F-8	Lucerne	Pa.	257	I-3	Ontario	Pa.
306	M-3	Lucille No. 2	W. Va.				
63		Lutz	Pa.				
300	M-3	Lynn	W. Va.				
				407		P. & G.	Pa.
				404		P. & K.	Pa.
				398		P. & N. No. 2	Pa.
44	D-10	McCartney No. 3 (Jordan No. 1)	Pa.	111	D-9	P. & N. No. 7	Pa.
46	D-10	McCartney No. 4 (Jordan No. 2)	Pa.	127	E-9	P. P. & K.	Pa.
392		McClure	Pa.	270	K-3	Palmer	Pa.
148	G-9	McFadden Dock	Pa.	361	F-5	Park	Pa.
394		McIntosh No. 2	Pa.	93	F-10	Patton Clay	Pa.
103		McPherson	Pa.	211	I-9	Peerage No. 2	Pa.
140	E-8	Mack No. 2	Pa.	175	H-10	Penker No. 1	Pa.
376		Mac No. 1	Pa.	421		Penn No. 3	Pa.
105	D-9	Mahaffey No. 1	Pa.	5		Penn No. 7 (Curtin Nos. 1 & 2)	Pa.
412		Mahood No. 4	Pa.	7	D-12	Penn No. 9	Pa.
290	L-3	Maiden	W. Va.	180	G-9	Pennsylvania No. 3	Pa.
280	L-3	Maple No. 3	Pa.	181	G-9	Pennsylvania No. 8	Pa.
50		Mapleton No. 5	Pa.	133	E-9	Pennsylvania No. 22	Pa.
244	H-4	Marchand	Pa.	162	F-9	Pine No. 1	Pa.
352	F-5	Marco	Pa.	139	F-9	Pine No. 2	Pa.
154		Mardon No. 4	Pa.	98		Pine Ridge No. 5	Pa.
302	M-3	Martha	W. Va.	83	E-10	Pine Run No. 1	Pa.
178	H-10	Martindale	Pa.	251		Piney Fork	Pa.
185	H-9	Maryland Shaft	Pa.	73		Plunket No. 1	Pa.
179	G-10	Maryland Shaft No. 2	Pa.	279	L-3	Poland No. 3	Pa.
307	M-3	Mason Dixon No. 1	W. Va.	282	L-3	Poland No. 4	Pa.
351	F-5	Mateer	Pa.	283	L-3	Poland No. 5	Pa.
327	J-3	Mather	Pa.	241	G-5	Poole No. 3	Pa.
68		Matthews No. 7	Pa.	173	H-10	Portage No. 2	Pa.
253	I-3	Mathies	Pa.	172	H-10	Portage No. 4	Pa.
267	J-3	Maxwell	Pa.	174		Portage No. 10	Pa.
155	G-9	Meegan No. 1	Pa.	75		Powell No. 1	Pa.
9		Meyer No. 1	Pa.	91		Powell No. 3	Pa.
37	D-11	Mid-Penn Nos. 4 & 5	Pa.	71		Powell No. 5	Pa.
43	D-10	Midway No. 1	Pa.	92		Powell No. 6	Pa.
60		Militant Smokeless No. 1	Pa.	397		Proctor No. 3	Pa.
124		Miller Run No. 5	Pa.	176		Prospect No. 1	Pa.
95	E-10	Miller Run No. 7	Pa.	301	M-3	Provins	W. Va.
393		Minns	Pa.	335	K-4	Puritan No. 1	Pa.
156	G-9	Monroe 31	Pa.	295	L-3	Pursglove No. 8	W. Va.
158	G-9	Monroe 32	Pa.	294	L-3	Pursglove No. 15	W. Va.
14		Moore No. 5	Pa.				
321	M-3	Morgan	W. Va.				
371	D-6	Mosgrove	Pa.				
12	D-12	Mountain Branch	Pa.				
215		Mountainside	Pa.				
31		Mountain Top	Pa.				
				340		Ragalini	Pa.
				16	D-11	Ramey No. 1	Pa.
				144		Randolph No. 2	Pa.
				146		Randolph No. 3	Pa.
				97	E-10	Red Top	Pa.
				208	J-9	Reitz No. 3	Pa.
250		Nassar	Pa.	207	J-9	Reitz No. 4	Pa.
330	K-3	Nemacolin	Pa.	198	I-9	Reitz No. 5	Pa.
277	K-4	New Geneva	Pa.	355	F-6	Relco	Pa.
367	G-4	Newfield	Pa.	151		Renglo	Pa.

**ALPHABETICAL LIST OF BITUMINOUS COAL MINES ON
THE PENNSYLVANIA RAILROAD AND LATERAL LINES**

**PENNSYLVANIA AND WEST VIRGINIA
EAST OF PITTSBURGH**

INDEX No.	MAP A	MINE	STATE	INDEX No.	MAP A	MINE	STATE
366	G-4	Renton No. 3	Pa.	109	D-9	Superior No. 1	Pa.
422		Rich Hill	Pa.	223	I-9	Superior No. 1	Pa.
99	E-10	Rich Hill Nos. 1 & 2	Pa.	249	I-5	Susan	Pa.
308	M-3	Ridge	W.Va.				
4		Riley No. 1	Pa.				
184	H-9	Riverside No. 2	Pa.				
291	L-3	Robinson Run	W. Va.				
177	H-10	Rock Tunnell	Pa.	387		Taylor	Pa.
271	K-3	Ronco	Pa.	202		Thermal Nos. 6 & 8	Pa.
289	L-3	Rosedale No. 1	W. Va.	128	E-9	Thermal No. 7	Pa.
288	L-3	Rosedale No. 1-S	W. Va.	164	G-8	Thompson No. 1	Pa.
287	L-3	Rosedale No. 3	W. Va.	414		Toy, Edwin W.	Pa.
281	L-3	Rosedale No. 7	Pa.	416		Toy No. 10	Pa.
				89	E-11	Troxell No. 2	Pa.
				396	A-10	Tyler No. 14	Pa.
242	G-6	Seanor-Loyal	Pa.				
39		Seckinger No. 1	Pa.				
220	I-9	Shaffer-Myron	Pa.	138		Valley No. 4	Pa.
234	H-9	Shaft	Pa.	362	E-5	Venturini	Pa.
67		Shannon Smokeless No. 1	Pa.	268	J-3	Vesta Coal Preparation Plant	Pa.
284	L-3	Shannopin	Pa.	260	J-3	Vesta Nos. 4 & 5	Pa.
386		Sherman No. 2	Pa.	153	G-9	Vinton No. 6	Pa.
383		Sherman No. 5	Pa.	28	E-11	Viola No. 1	Pa.
21		Shirley No. 1	Pa.	26		Viola No. 3	Pa.
36		Shirley No. 2	Pa.	309	M-3	Virginia	W. Va.
152		Shuman Run Dock	Pa.	166	G-8	Virginian No. 14	Pa.
209	I-9	Shuster	Pa.	163	G-8	Virginian No. 15	Pa.
120		Sloan Dock, F. C.	Pa.				
110	D-9	Smith Nos. 1 & 2	Pa.				
169	G-10	Sonman No. 2	Pa.				
171	G-10	Sonman Slope	Pa.				
264		South Union No. 1	Pa.				
316	M-3	South Union No. 11	W. Va.	385		Wallwork No. 1	Pa.
130	E-9	Spangler No. 3	Pa.	66		Warroquier	Pa.
391	B-9	Spencer & Mauk	Pa.	348	G-6	Watson	Pa.
126	F-9	Springfield No. 4	Pa.	246	I-5	Webco	Pa.
101	E-10	Springfield No. 6	Pa.	213	I-9	Werry No. 11	Pa.
405		Stahlman No. 1	Pa.	380		West Freedom Nos. 1 & 2	Pa.
406		Stahlman No. 2	Pa.	402		Westport	Pa.
15		Stanley	Pa.	187	H-10	Windber Hi-Standard	Pa.
123	F-9	Sterling No. 1	Pa.	210	I-9	Windber No. 2	Pa.
22		Sterling No. 3	Pa.	132	E-9	Woodland No. 2	Pa.
77		Sterling No. 3	Pa.	214	I-9	Wyatt Nos. 1 & 3	Pa.
122		Sterling No. 6	Pa.				
403		Sterling Run	Pa.				
293	L-3	Stewart	W. Va.				
183	H-9	Stineman Nos. 1 & 3	Pa.				
182	H-9	Stineman No. 4	Pa.				
226	H-9	Stineman No. 12	Pa.	225	H-9	Yeager	Pa.
107	D-9	Summit Dock (Arcadia Coal Co.)	Pa.	34	D-11	Yorkshire	Pa.
413		Sunbeam	Pa.	65		Young No. 1	Pa.
276	K-3	Sunshine No. 2	Pa.	64		Young No. 2	Pa.

**GREENWICH PIERS, PHILADELPHIA, PENNA.
Tidewater Coal Dumping Facilities**



Greenwich, Philadelphia, tidewater coal facilities are the most modern transshipping facilities along the Atlantic Seaboard. These facilities were expressly designed for the handling of Coal and Coke in volume in all seasons and under all conditions of weather and are conveniently located to serve the entire Philadelphia Harbor as well as all coastwise and export trade.

The facilities consist of two of the latest type rotary coal dumpers, one on each side of a pier, 1,100 feet long and 168 feet wide, with sufficient berthing space for all types of vessels.

These dumpers are equipped with conveyors and tele-

scopic chutes so that the coal slides into the hold of vessel without dropping, thus preventing breakage.

These combined facilities are capable of handling approximately 25,000 tons per day (24 hours).

Modern bunker facilities equipped with scales are also provided for coaling tugs and other small vessels.

There is also provided a modern thawing plant of 60 cars capacity for thawing frozen coal during extremely cold weather.

Ample and conveniently located supporting track storage facilities are available to make possible the most rapid movement of loaded cars to the dumpers.

Dimensions and gross weight of cars which can be handled over these dumpers are:

<i>Maximum Length Over Couplers</i>	<i>Maximum Height</i>	<i>Minimum Height</i>	<i>Maximum Width</i>	<i>Maximum Gross Weight</i>
54'0"	12'0"	7'0"	10'6"	324,000 lbs.

MAIL ADDRESS:

Agent, Pennsylvania Railroad,
Greenwich Coal Piers,
Philadelphia 48, Pa.
Telephone: FULton 9-0340

Commercial reproduction prohibited
Downloaded from http://PRR.Railfan.net/documents
Scanned by Rob Schoenberg, ©2010

CANTON PIERS, BALTIMORE, MARYLAND

Tidewater Coal Dumping Facilities



Baltimore tidewater coal facilities are conveniently located so as to be accessible to all coastwise and export trade, as well as the entire Baltimore Harbor district.

The facilities consisting of one Mead-Morrison car dumper, the coal being dumped into a 100-ton capacity receiving hopper and from there conveyed to the loading machines on the pier by means of four-ton capacity cars operated on an endless cable.

The pier is 925 feet long and 66 feet wide, with ample berthing space to accommodate any type of vessel.

The pier is equipped with four movable loaders, one of which is also equipped with a standard scale to weigh all coal passing through it and is especially adapted for bunkering tugs and other small vessels.

This pier is capable of handling 20,000 tons per day (24 hours).

Facilities are provided for the efficient thawing of frozen coal during extremely cold weather.

Ample and conveniently located supporting track facilities are also available to make possible the most rapid movement of loaded cars to the dumper.

Dimensions and gross weight of cars which can be handled over this dumper are:

<i>Maximum Length Over Couplers</i>	<i>Maximum Height</i>	<i>Minimum Height</i>	<i>Maximum Width</i>	<i>Maximum Gross Weight</i>
54'0"	12'4"	6'0"	12'0"	280,000 lbs.

Agent, Pennsylvania Railroad,
Canton Coal Piers,
2204 S. Clinton Street,
Baltimore 24, Md.

MAIL ADDRESS: 2204 S. Clinton Street,
Baltimore 24, Md.
Telephone: Mulberry 4800, Extension 346

Commercial reproduction prohibited
Downloaded from http://PRR.Railfan.net/documents
Scanned by Rob Schoenberg, ©2010

**GEOGRAPHICAL LIST OF BITUMINOUS COAL MINES ON
THE PENNSYLVANIA RAILROAD AND LATERAL LINES**

**PENNSYLVANIA AND WEST VIRGINIA
EAST OF PITTSBURGH**

INDEX No.	MAP A	MINE	LOCATION OF MINE AT OR NEAR	OPERATOR	P. O. ADDRESS
		PENNSYLVANIA RAILROAD			
		Pittsburgh Region			
		Middle District			
		Snow Shoe Branch			
		Sugar Camp Branch			
1		Lehigh Valley No. 28	Snow Shoe Pa.	R. S. Carlin, Inc.	Snow Shoe Pa.
2	C-13	Knox Run No. 8	Snow Shoe Pa.	Knox Run Coal Co.	Snow Shoe Pa.
3		Cherry Run No. 4	Snow Shoe Pa.	Cherry Run Coal Mining Co.	Snow Shoe Pa.
		Clearfield Branch			
4		Riley No. 1	Osceola Mills Pa.	Elliot Coal Mining Co.	Philipsburg Pa.
		Moshannon Branch			
5		Curtin Nos. 1 & 2 (Penn No. 7)	Osceola Mills Pa.	Elliot Coal Mining Co.	Philipsburg Pa.
6		Hill No. 1	Osceola Mills Pa.	Elliot Coal Mining Co.	Philipsburg Pa.
7	D-12	Penn No. 9	Osceola Mills Pa.	Elliot Coal Mining Co.	Philipsburg Pa.
		Trout Run Branch			
8	D-12	Du Shan No. 3	Trout Run Jct. Pa.	James F. Dugan Coal Co.	Osceola Mills Pa.
		Big Run Branch			
9		Meyer No. 1	Big Run Jct. Pa.	Meyer Bros.	Philipsburg Pa.
		Moshannon & Clearfield Br.			
10	D-12	Banner	Osceola Mills Pa.	Rice Brothers Coal Co.	Philipsburg Pa.
11	D-12	Bear Run	Osceola Mills Pa.	Dahlin Brothers	Houtzdale Pa.
		Ednie Branch			
12	D-12	Mountain Branch	Osceola Mills Pa.	Harchak & Lucas	Houtzdale Pa.
13	D-12	Cortland	Osceola Mills Pa.	Harchak & Lucas	Houtzdale Pa.
14		Moore No. 5	Osceola Mills Pa.	W. G. Moore & Son	Philipsburg Pa.
15		Stanley	Houtzdale Pa.	Kittanning Coal Co.	Osceola Mills Pa.
16	D-11	Ramey No. 1	Houtzdale Pa.	Clyde Coal Co.	Philipsburg Pa.
17		Henrietta No. 6	Houtzdale Pa.	J. H. Wallin Estate	Philipsburg Pa.
		Coal Run Branch			
18	D-12	Ashland	Coal Run Jct. Pa.	Smith Coal Co.	Brisbin Pa.
19	D-12	Imperial Nos. 10 & 12	Coal Run Jct. Pa.	Wilkes Coal Co.	Houtzdale Pa.
20		Imperial No. 11	Coal Run Jct. Pa.	John Pinto	Osceola Mills Pa.
		Burley Branch			
21		Shirley No. 1	Coal Run Jct. Pa.	W. G. Moore & Son	Philipsburg Pa.
22		Sterling No. 3	Houtzdale Pa.	Howard Rowland	Philipsburg Pa.
		Houtzdale Branch			
23		Houtzdale	Houtzdale Pa.	W. O. Gulbranson	Houtzdale Pa.
		Amesville Branch			
24		De Romo	Houtzdale Pa.	John A. De Romo Coal Co.	Houtzdale Pa.
25		Amesville 30	Houtzdale Pa.	Smith Estate	Clearfield Pa.
		Little Muddy Run Branch			
		Janesville Branch			
26		Viola No. 3	Smoke Run Pa.	S. J. Mountz & Co.	Smith Mills Pa.
27		King No. 1	Smoke Run Pa.	Dean Coal Co.	Ramey Pa.
28	E-11	Viola No. 1	Smoke Run Pa.	Elliot Coal Mining Co.	Philipsburg Pa.
29	E-11	Clyde No. 28	Smoke Run Pa.	Clyde Coal Co.	Philipsburg Pa.
		Muddy Run Branch			
30	E-11	Leland No. 1	Beccaria Pa.	W. O. Gulbranson	Houtzdale Pa.
31		Mountain Top	Beccaria Pa.	Dean Coal Co.	Ramey Pa.
32	E-11	Glenmar No. 1	Beccaria Pa.	Moshannon Smithing Coal Corp.	{ P. O. Box 178, Ramey Pa.
33	E-11	Leland No. 10	Beccaria Pa.	Leland Coal Mining Co. (Dexter-Carpenter)	{ 32 Broadway, New York N.Y.
		Banian Branch			
34	D-11	Yorkshire	Banian Jct. Pa.	Yorkshire Coal Co., Inc.	Madera Pa.
35	D-11	Homestead	Banian Jct. Pa.	Yorkshire Coal Co., Inc.	Madera Pa.
36		Shirley No. 2	Banian Jct. Pa.	W. G. Moore & Son	Philipsburg Pa.
37	D-11	Mid Penn Nos. 4 & 5	Madera Pa.	Middle Penna. Coal Corp.	Madera Pa.
38		Alexander	Madera Pa.	Middle Penna. Coal Corp.	Madera Pa.
39		Seckinger No. 1	Madera Pa.	Seckinger Coal Co.	Madera Pa.
40		Bellsena	Madera Pa.	C. E. Powell Coal Co.	Blandburg Pa.
41		Corona	McCartney Pa.	Middle Penna. Coal Corp.	Madera Pa.
42		Elliot No. 4	McCartney Pa.	Elliot Coal Mining Co.	Philipsburg Pa.
43	D-10	Midway No. 1	McCartney Pa.	Midway Coal Co.	McCartney Pa.
44	D-10	McCartney No. 3 (Jordan No. 1)	McCartney Pa.	Jordan Coal Co.	Philipsburg Pa.
45	D-10	Creekside	McCartney Pa.	Creekside Coal Co.	Clearfield Pa.
46	D-10	McCartney No. 4 (Jordan No. 2)	McCartney Pa.	Jordan Coal Co.	Philipsburg Pa.

**GEOGRAPHICAL LIST OF BITUMINOUS COAL MINES ON
THE PENNSYLVANIA RAILROAD AND LATERAL LINES**

**PENNSYLVANIA AND WEST VIRGINIA
EAST OF PITTSBURGH**

INDEX No.	MAP A	MINE	LOCATION OF MINE AT OR NEAR	OPERATOR	P. O. ADDRESS
		PENNSYLVANIA RAILROAD (cont'd)			
		Pittsburgh Region (cont'd)			
		Clearfield Branch (cont'd)			
47	D-12	Elliot	Osceola Mills Pa.	Elliot Coal Mining Co.	Philipsburg Pa.
48	D-12	Bigelow Run	Osceola Mills Pa.	Bigelow Run Coal Co.	Philipsburg Pa.
49		Beaver	Osceola Mills Pa.	Albert J. Eyerly	Philipsburg Pa.
		Mapleton Branch No. 1			
		Mapleton Branch No. 2			
50		Mapleton No. 5	Boynton Pa.	Morrisdale Coal Mining Co.	{ Fidelity-Phila. Trust Bldg., Phila. Pa.
		Coaldale No. 3			
51		Coaldale No. 3	Boynton Pa.	Elliot Coal Mining Co.	Philipsburg Pa.
52	D-12	Bond Hill	Philipsburg Pa.	Fred Hoffer	Philipsburg Pa.
53		Copelin	Philipsburg Pa.	Elliot Coal Mining Co.	Philipsburg Pa.
54		Howard No. 6	Philipsburg Pa.	Howard Coal Co.	Philipsburg Pa.
55		Loch Lomond	Philipsburg Pa.	Raines, George M.	Philipsburg Pa.
56		Garland	Sanford Jct. Pa.	Raines, George M.	Philipsburg Pa.
57		Guival No. 1	Sanford Jct. Pa.	Kristianson & Johnson	Philipsburg Pa.
		Graham Branch			
58		Graham	Graham Pa.	Elliot Coal Mining Co.	Philipsburg Pa.
59		F. C. M.	Wallaceton Pa.	Thompson Coal Co.	Philipsburg Pa.
60		Militant Smokeless No. 1	Bigler Pa.	Bradford Coal Co.	Bigler Pa.
61		Cooper Smokeless No. 1	Bigler Pa.	Bradford Coal Co.	Bigler Pa.
62		Burnsworth	Woodland Pa.	Lutz Coal Co.	Clearfield Pa.
63		Lutz	Woodland Pa.	Lutz Coal Co.	Clearfield Pa.
64		Young No. 2	Clearfield Pa.	Litten, J. L.	Clearfield Pa.
65		Young No. 1	Clearfield Pa.	E. M. Brown, Inc.	Clearfield Pa.
66		Warroquier	Clearfield Pa.	Warroquier Coal Co.	Clearfield Pa.
67		Shannon Smokeless No. 1	Curwensville Pa.	Bradford Coal Co.	Bigler Pa.
68		Mathews No. 7	Grampian Pa.	John H. Mathews	Grampian Pa.
69		Belfast No. 2	Grampian Pa.	Belfast Coal Co.	Clearfield Pa.
		Ironva Branch			
70		Lens No. 1	Ashville Pa.	Royal Smokeless Coal Co.	Johnstown Pa.
71		Powell No. 5	Dysart Pa.	C. E. Powell Coal Co.	Blandburg Pa.
72		Laurel Run No. 1	Dysart Pa.	Bailey and Caskey	Coalport Pa.
73		Plunket No. 1	Dean Pa.	Burkhart Coal Co.	Cresson Pa.
74	F-11	Burkhart	Dean Pa.	Burkhart Coal Co.	Cresson Pa.
75		Powell No. 1	Frugality Pa.	C. E. Powell Coal Co.	Blandburg Pa.
76		Lilly No. 8	Van Ormer Pa.	C. A. Hughes & Co.	Box 28, Cresson Pa.
77		Sterling No. 3	Van Ormer Pa.	C. E. Powell Coal Co.	Blandburg Pa.
78		Bland No. 4	Fallen Timber Pa.	C. E. Powell Coal Co.	Blandburg Pa.
79	E-10	Cambria Mills No. 3	Fallen Timber Pa.	Apple Coal Mining Co.	Fallen Timber Pa.
80		King No. 1	Flinton Pa.	Dean Coal Co.	Ramey Pa.
81	E-10	Colonial No. 6	Flinton Pa.	Freedom Coal Co.	Flinton Pa.
82		Irvona No. 1	Irvona Pa.	Elliot Coal Mining Co.	Philipsburg Pa.
		Bellwood Branch			
		Pine Run Branch			
83	E-10	Pine Run No. 1	Irvona Pa.	River Smokeless Coal Co.	Clearfield Pa.
84		Cambria Smokeless 1-D	Blain City Pa.	Imperial Coal Corp. (Cambria Smokeless Coal Co.)	Johnstown Pa.
85	E-10	Cambria Smokeless No. 1	Coalport Pa.	Imperial Coal Corp. (Cambria Smokeless Coal Co.)	Johnstown Pa.
86	E-10	Oakland No. 3	Coalport Pa.	Covert & Hagerty	Coalport Pa.
87		Bowers No. 1	Coalport Pa.	Bowers Coal Co.	Coalport Pa.
88	E-11	Cammos No. 1	Coalport Pa.	Middle Penna. Coal Corp.	Madera Pa.
89	E-11	Troxell No. 2	Glasgow Pa.	Scott Bros.	Glasgow Pa.
90	E-11	Cambria Mills No. 2	Glasgow Pa.	Apple Coal Mining Co.	Fallen Timber Pa.
91		Powell No. 3	Blandburg Pa.	C. E. Powell Coal Co.	Blandburg Pa.
92		Powell No. 6	Blandburg Pa.	C. E. Powell Coal Co.	Blandburg Pa.
		Cresson Branch			
		Patton Branch No. 1			
93	F-10	Patton Clay	Patton Pa.	Patton Clay Mfg. Co.	Patton Pa.
94	E-10	Chest Creek No. 1	Thomas Mill Pa.	Chest Creek Coal Co.	Osceola Mills Pa.
		Hastings Branch			
95	E-10	Miller Run No. 7	Garway Pa.	Chest Creek Coal Co.	Osceola Mills Pa.
96	E-10	Hastings No. 1	Hastings Pa.	Cortright Coal Co. (Hastings Fuel Co.)	12 So. 12th St., Phila. Pa.

**GEOGRAPHICAL LIST OF BITUMINOUS COAL MINES ON
THE PENNSYLVANIA RAILROAD AND LATERAL LINES**

**PENNSYLVANIA AND WEST VIRGINIA
EAST OF PITTSBURGH**

INDEX No.	MAP A	MINE	LOCATION OF MINE AT OR NEAR	OPERATOR	P. O. ADDRESS
		PENNSYLVANIA RAILROAD (cont'd)			
		Pittsburgh Region (cont'd)			
		Cresson Branch (cont'd)			
		Hastings Branch (cont'd)			
97	E-10	Red Top	Hastings	Red Top Coal Co.	Spangler
98		Pine Ridge No. 5	Hastings	North Cambria Fuel Co. .	Patton
99	E-10	Rich Hill Nos. 1 & 2	Hastings	Rich Hill Coal Mining Corp.	Cresson
100		Lanark No. 1	Hastings	Clark Mineral Coal Co. .	Hastings
		Kings Run Branch			
101	E-10	Springfield No. 6	Westover	Cambria-Clearfield Mng. Co. (Peale, Peacock & Kerr Inc.)	St. Benedict
102	D-10	Benjamin No. 3	Five Points	Benjamin Coal Co.	Ansonville
		La Jose Branch			
103		McPherson	La Jose	Chest Coal Co.	Ramey
104	D-10	Lee Hollow No. 3	La Jose	Milchak Coal Co.	Hastings
		Mahaffey Branch			
105	D-9	Mahaffey No. 1	Mahaffey	Mrs. F. C. Mahaffey	Mahaffey
		McGees Branch			
		Brady Run Branch			
106		Brady Run Dock	Glen Campbell ..	Anita Coal Mining Co. .	Punxsutawney
		Glen Campbell Branch			
107	D-9	Summit Dock (Arcadia Coal Co.)	Glen Campbell ..	P. & N. Coal Co.	Punxsutawney
		McCoy Run Branch			
108	D-9	Lampkie No. 1	Glen Campbell ..	Lampkie Bros.	Glen Campbell
		Bear Run Branch			
109	D-9	Superior No. 1	Lockvale	Chest Coal Co.	Ramey
110	D-9	Smith Nos. 1 & 2	Lockvale	W. A. Smith & Son	Glen Campbell
111	D-9	P. & N. No. 7	Hillman	P. & N. Coal Co.	Punxsutawney
		Hillman Branch			
112		Gregg & Riddle	Hillman	Gregg & Riddle	Burnside
113		Clover Run	Hillman	Pamco Coal Co.	Columbus
114		Kann No. 4	Bowersville	Kann & Gutsie	{ R. D. No. 2, Punxsutawney
115		Barilar	Punxsutawney ..	Barilar Coal Co., Inc. .	Anita
116		Blose Dock	Punxsutawney ..	C. E. Blose	Punxsutawney
		Elk Run Branch			
117	C-8	Anita Dock	Punxsutawney ..	Anita Coal Mining Co. .	Punxsutawney
118	C-8	Anita No. 1	Anita	Anita Coal Mining Co. .	Punxsutawney
119	C-8	Lindsey No. 8	Horatio	Lindsey Coal Mining Co. .	Punxsutawney
		Susquehanna Extension			
120		F. C. Sloan Dock	Carrolltown	Dr. F. C. Sloan	Barnesboro
121	F-10	Lancashire No. 20	Carrolltown	Barnes & Tucker Co. .	Barnesboro
		Luther Branch			
122		Sterling No. 6	Bakerton	Sterling Coal Co.	Elmora
		Sterling Branch			
123	F-9	Sterling No. 1	Bakerton	Sterling Coal Co.	Elmora
124		Miller Run No. 5	Bakerton	McCombie Coal Co.	Spangler
125	F-9	Lancashire No. 15	Bakerton	Barnes & Tucker Co. .	Barnesboro
126	F-9	Springfield No. 4	Spangler	Springfield Coal Corp. (Peale, Peacock & Kerr Inc.)	St. Benedict
		Walnut Run Branch			
127	E-9	P. P. & K.	Barnesboro	Pavelca & Pendersen .	Barnesboro
128	E-9	Thermal No. 7	Barnesboro	Press Coal Co.	Barnesboro
129	E-10	Cymbria	Barnesboro	Butterworth Fuel Co. .	Barnesboro
130	E-9	Spangler No. 3	Barnesboro	Last Chance Coal Co. .	Emich
		Porter Run Branch			
131	E-9	Delta No. 2	Barnesboro	McCormick Coal Co. .	Barnesboro
		Moss Creek Branch			
132	E-9	Woodland No. 2	Garman	Derringer Fuel Co.	Spangler
133	E-9	Pennsylvania No. 22	Garman	Pennsylvania Coal & Coke Corp.	{ 30 Pine St., New York

Commercial reproduction prohibited
Downloaded from http://PRR.Railfan.net/documents
Scanned by Rob Schoenberg, ©2010

GEOGRAPHICAL LIST OF BITUMINOUS COAL MINES ON THE PENNSYLVANIA RAILROAD AND LATERAL LINES

PENNSYLVANIA AND WEST VIRGINIA EAST OF PITTSBURGH

INDEX No.	MAP A	MINE	LOCATION OF MINE AT OR NEAR	OPERATOR	P. O. ADDRESS
CHERRY TREE & DIXONVILLE RAILROAD					
134	E-9	Fisher No. 1	Fleming Summit Pa.	H. & H. Coal Co.	Dixonville Pa.
135	E-9	Commodore	Commodore Pa.	H. & H. Coal Co.	Dixonville Pa.
136	E-8	Glenside No. 2	Starfield Pa.	James Coal Co.	Kittanning Pa.
137	E-8	Joseph No. 1	Shanktown Pa.	Capizzi Coal Co.	Indiana Pa.
138		Valley No. 4	Heilwood Pa.	Valley Coal Co.	Heilwood Pa.
139	F-9	Pine No. 2	Heilwood Pa.	Pine Township Coal Co.	Heilwood Pa.
140	E-8	Mack No. 2	Diamondville Pa.	Wilmore Fuel Co.	Johnstown Pa.
141	E-8	Keystone	Clymer Pa.	Imperial Keystone Coal Co.	Johnstown Pa.
142	E-8	Clymer No. 2	Clymer Pa.	Morrisdale Coal Mining Co.	{ Fidelity-Phila. Trust Bldg., Phila. Pa.
143	E-8	Clymer No. 3	Clymer Pa.	Clearfield Bituminous Coal Co.	Indiana Pa.
144		Randolph No. 2	Dixonville Pa.	Passmore Coal Co.	Mahaffey Pa.
145	E-8	Barr Slope	Dixonville Pa.	Clearfield Bituminous Coal Co.	Indiana Pa.
146		Randolph No. 3	Dixonville Pa.	Crago Coal Co.	Philipsburg Pa.
147	E-8	Hess No. 2	Dixonville Pa.	Hess Coal Co.	Dixonville Pa.
PENNSYLVANIA RAILROAD (cont'd)					
Pittsburgh Region (cont'd)					
Cresson Branch (cont'd)					
Black Lick Branch					
Coal Pit Run Branch					
148	G-9	McFadden Dock	Twin Rocks Pa.	Commercial Coal Mng. Co. of Twin Rocks	Twin Rocks Pa.
149	G-9	Commercial No. 5	Twin Rocks Pa.	Black Lick Coal Mng. Co. (Fred McFadden)	Edensburg Pa.
150	G-9	Cardiff No. 1	Twin Rocks Pa.	Imperial Cardiff Coal Co. (Imperial Coal Corp.)	Johnstown Pa.
151		Renglo	Twin Rocks Pa.	Barnes & Tucker Co.	Barnesboro Pa.
Shuman Run Branch					
152		Shuman Run Dock	Vintondale Pa.	Jackson Hill Coal Co. (J. U. McFadden)	Edensburg Pa.
153	G-9	Vinton No. 6	Vintondale Pa.	Vinton Coal & Coke Co. (Delano Coal Co.)	{ 570 Lexington Ave., New York N.Y.
CAMBRIA & INDIANA RAILROAD					
154		Mardon No. 4	Nanty-Glo Pa.	J. U. McFadden	Edensburg Pa.
155	G-9	Meegan No. 1	Nanty-Glo Pa.	D-11 Coal Co.	Hastings Pa.
156	G-9	Monroe 31	Nanty-Glo Pa.	Bethlehem Mines Corp. (Bethlehem Steel Co.)	Bethlehem Pa.
157		Lincoln No. 1	Nanty-Glo Pa.	Joseph E. Yobbagy	Edensburg Pa.
158	G-9	Monroe 32	Revloc Pa.	Bethlehem Mines Corp. (Bethlehem Steel Co.)	Bethlehem Pa.
159	G-9	Cardiff No. 1 (Also Served Direct by P.R.R.)	Cardiff Pa.	Imperial Cardiff Coal Co. (Imperial Coal Corp.)	Johnstown Pa.
160	F-9	Ebensburg No. 1	Colver Pa.	Ebensburg Coal Co. (Coleman & Co.)	{ 123 So. Broad St., Phila. Pa.
161		D. & S.	White Mills Pa.	D. & S. Coal Co.	{ R. D. No. 1, Penn Run Pa.
162	F-9	Pine No. 1	Sides Pa.	Pine Township Coal Co.	Heilwood Pa.
PENNSYLVANIA RAILROAD (cont'd)					
Pittsburgh Region (cont'd)					
Cresson Branch (cont'd)					
Black Lick Branch (cont'd)					
163	G-8	Virginian No. 15	Dias Pa.	J. Gordon Coal Co.	Indiana Pa.
164	G-8	Thompson No. 1	Dias Pa.	Thompson Coal Co.	Blairsville Pa.
165	G-8	Heshbon No. 2	Heshbon Pa.	Heshbon Coal Co.	Johnstown Pa.
166	G-8	Virginian No. 14	Heshbon Pa.	Crichton Coal & Coke Co.	Johnstown Pa.
167	G-7	Bennett No. 1	Josephine Pa.	J. J. Davidson	Black Lick Pa.
New Portage Branch					
168	G-11	Bennington "B"	Gallitzin Pa.	Argyle Coal Co.	{ 1st National Bank Bldg., Johnstown Pa.
Lilly Branch					
169	G-10	Sonman No. 2	Lilly Pa.	W. H. Piper & Co.	Lilly Pa.
170	G-10	Lilly No. 3	Lilly Pa.	C. A. Hughes & Co.	Box 28, Cresson Pa.

Commercial reproduction prohibited
Downloaded from http://PRR.Railfan.net/documents
Scanned by Rob Schoenberg, ©2010

**GEOGRAPHICAL LIST OF BITUMINOUS COAL MINES ON
THE PENNSYLVANIA RAILROAD AND LATERAL LINES**

**PENNSYLVANIA AND WEST VIRGINIA
EAST OF PITTSBURGH**

INDEX No.	MAP A	MINE	LOCATION OF MINE AT OR NEAR	OPERATOR	P. O. ADDRESS
PENNSYLVANIA RAILROAD (cont'd)					
Pittsburgh Region (cont'd)					
Bens Creek Branch					
Sonman Branch					
171	G-10	Sonman Slope	Portage Pa.	Eastern Gas & Fuel Assoc.	{ Koppers Bldg., Pittsburgh Pa.
Martin Branch					
172	H-10	Portage No. 4	Portage Pa.	Johnstown Coal & Coke Co.	{ U. S. National Bank Bldg., Johnstown .. Pa.
173	H-10	Portage No. 2	Portage Pa.	Johnstown Coal & Coke Co.	{ U. S. National Bank Bldg., Johnstown .. Pa.
174		Portage No. 10	Portage Pa.	Johnstown Coal & Coke Co.	{ U. S. National Bank Bldg., Johnstown .. Pa.
175	H-10	Penker No. 1	Portage Pa.	Stoker Coal Co.	Lloydell Pa.
176		Prospect No. 1	Portage Pa.	Prospect Coal Co.	Portage Pa.
177	H-10	Rock Tunnel	Portage Pa.	Rock Tunnel Coal Co. ...	Portage Pa.
178	H-10	Martindale	Portage Pa.	Portage-Kittanning Coal Co.	Portage Pa.
179	G-10	Maryland Shaft No. 2	Wilmore Pa.	Berwind-White Coal Mining Co.	{ Pennsylvania Bldg., Philadelphia 2 Pa.
Summerhill Branch					
180	G-9	Pennsylvania No. 3	Ehrenfeld Pa.	Pennsylvania Coal & Coke Corp.	{ 30 Pine St., New York N. Y.
181	G-9	Pennsylvania No. 8	Ehrenfeld Pa.	Pennsylvania Coal & Coke Corp.	{ 30 Pine St., New York N. Y.
South Fork Branch					
Stineman Siding					
182	H-9	Stineman No. 4	South Fork Pa.	Stineman Coal & Coke Co.	{ Suburban Station Bldg., Phila. Pa.
183	H-9	Stineman Nos. 1 & 3	South Fork Pa.	Stineman Coal & Coke Co.	{ Suburban Station Bldg., Phila. Pa.
184	H-9	Riverside No. 2	South Fork Pa.	Adams Fuel Corp.	South Fork Pa.
185	H-9	Maryland Shaft	St. Michael Pa.	Berwind-White Coal Mining Co.	{ Pennsylvania Bldg., Phila. 2 Pa.
Beaver Branch					
Llanfair Branch					
186	H-10	Burichin	Dunlo Pa.	Burichin Coal Co.	Dunlo Pa.
187	H-10	Windber Hi-Standard	Dunlo Pa.	Beechnut Coal Co.	{ 118 Graham St., Windber Pa.
188	H-10	Kryan	Dunlo Pa.	T. Obreza	Windber Pa.
189	H-10	Lloydell No. 2	Dunlo Pa.	Hudec Collieries Co., Inc.	{ Elton Road, R. D. No. 3, Johnstown .. Pa.
190		Henrietta	Dunlo Pa.	Henrietta Coal Mining Co.	Dunlo Pa.
191		Leamer No. 1	Dunlo Pa.	Leamer Coal Co.	Dunlo Pa.
192	H-10	Logan No. 3	Lloydell Pa.	Johnstown Coal & Coke Co.	{ U. S. National Bank Bldg., Johnstown .. Pa.
193	H-10	Cortright No. 1	Lloydell Pa.	Johnstown Coal & Coke Co.	{ U. S. National Bank Bldg., Johnstown .. Pa.
194	H-10	Logan No. 4	Lloydell Pa.	Johnstown Coal & Coke Co.	{ U. S. National Bank Bldg., Johnstown .. Pa.
195	H-10	Lick Run	Lloydell Pa.	Lick Run Coal Co.	Lloydell Pa.
Paint Creek Branch					
Eureka Branch No. 37					
196	H-9	Eureka No. 40	Windber Pa.	Berwind-White Coal Mining Co.	{ Pennsylvania Bldg., Phila. 2 Pa.
197	H-9	Eureka No. 37	Windber Pa.	Berwind-White Coal Mining Co.	{ Pennsylvania Bldg., Phila. 2 Pa.
Shade Creek Branch					
198	I-9	Reitz No. 5	Scalp Level Pa.	Reitz Coal Co.	Windber Pa.
199	I-9	Beechnut No. 1	Hillsboro Pa.	Beechnut Coal Co.	{ 118 Graham St., Windber Pa.
200	I-9	Decca Nos. 2 & 3	Hillsboro Pa.	Apple Coal Mining Co. ...	Fallen Timber Pa.
201	I-9	"B" Quality No. 9	Hillsboro Pa.	"B" Quality Coal Co. ...	Windber Pa.

Commercial reproduction prohibited
Downloaded from http://PRR.Railfan.net/documents
Scanned by Rob Schoenberg, ©2010

GEOGRAPHICAL LIST OF BITUMINOUS COAL MINES ON THE PENNSYLVANIA RAILROAD AND LATERAL LINES

PENNSYLVANIA AND WEST VIRGINIA EAST OF PITTSBURGH

INDEX No.	MAP A	MINE	LOCATION OF MINE AT OR NEAR	OPERATOR	P. O. ADDRESS
PENNSYLVANIA RAILROAD (cont'd)					
Pittsburgh Region (cont'd)					
South Fork Branch (cont'd)					
Paint Creek Branch (cont'd)					
Shade Creek Branch (cont'd)					
202		Thermal Nos. 6 & 8	Miller Run Pa.	Thermal Run Coal Mining Co.	Windber Pa.
203	I-9	Arrow	Miller Run Pa.	Arrow Coal Corp.	Windber Pa.
204		Bigan Nos. 22 & 23	Miller Run Pa.	Bigan Coal Co.	Windber Pa.
205	I-9	Loyal Hanna No. 6	Cairnbrook Pa.	Loyal Hanna Coal & Coke Co.	{ 1100 Commercial Trust Bldg., Phila. 2. Pa.
206	I-9	Berkey	Cairnbrook Pa.	H. Clay Stickel	Cairnbrook Pa.
207	J-9	Reitz No. 4	Central City Pa.	Reitz Coal Co.	Windber Pa.
208	J-9	Reitz No. 3	Central City Pa.	Reitz Coal Co.	Windber Pa.
Windber Siding					
209	I-9	Shuster	Windber Pa.	Shuster Coal Co.	9th St., Windber Pa.
210	I-9	Windber No. 2	Windber Pa.	Foster Shaffer	Windber Pa.
211	I-9	Peerage No. 2	Windber Pa.	Peerless Coal Co.	{ 913 Montgomery Ave., Narberth Pa.
212		Dalton Run No. 2	Windber Pa.	Dalton Run Coal Co.	Hillsboro Pa.
213	I-9	Werry No. 11	Windber Pa.	Werry Coal Co.	Vineland N.J.
214	I-9	Wyatt Nos. 1 & 3	Windber Pa.	Windber Hi-Grade Coal Co.	Windber Pa.
215		Mountainside	Windber Pa.	Mountainside Coal Co.	Windber Pa.
216		Constantino	Windber Pa.	Jos. Constantino	{ 1012 Graham Ave., Windber Pa.
217	I-9	"B" Quality No. 8	Windber Pa.	"B" Quality Coal Co.	Windber Pa.
218	I-9	Hritz No. 1	Windber Pa.	Geo. Hritz	Windber Pa.
219	I-9	Ogletown	Windber Pa.	Ogletown Coal Co.	Ogletown Pa.
220	I-9	Shaffer-Myron	Windber Pa.	Myron Shaffer	Rummell Pa.
221	I-9	Estep No. 2	Windber Pa.	Estep Coal Co.	Central City Pa.
222	I-9	Estep No. 1	Windber Pa.	Estep Coal Co.	Central City Pa.
223	I-9	Superior No. 1	Windber Pa.	A. F. Verna Coal Sales	Windber Pa.
JOHNSTOWN & STONY CREEK R.R.					
224	H-9	Imperial No. 10	Johnstown Pa.	Imperial Coal Corp.	Johnstown Pa.
225	H-9	Yeager	Johnstown Pa.	Trone Coal Co.	{ 101 Hillcrest Ave., Johnstown Pa.
226	H-9	Stineman No. 12	Johnstown Pa.	Stineman Coal & Coke Co.	{ 259 Grove Ave., Johnstown Pa.
227	H-9	Bird No. 3	Johnstown Pa.	Bird Coal Co.	Tire Hill Pa.
228	H-9	Bens Creek No. 1	Ferndale Pa.	Bens Creek Coal Co.	Johnstown Pa.
229	H-9	East Windber No. 4	Johnstown Pa.	East Windber Coal Co.	Johnstown Pa.
CONEMAUGH & BLACK LICK R.R.					
230	H-9	Bethlehem No. 74	Johnstown Pa.	Bethlehem Mines Corp. (Bethlehem Steel Co.)	Bethlehem Pa.
231		Deal & Lantzy	Johnstown Pa.	Deal & Lantzy Coal Co.	Boswell Pa.
232	H-9	Bethlehem No. 73	Johnstown Pa.	Bethlehem Mines Corp. (Bethlehem Steel Co.)	Bethlehem Pa.
233	H-9	Bethlehem No. 72	Johnstown Pa.	Bethlehem Mines Corp. (Bethlehem Steel Co.)	Bethlehem Pa.
PENNSYLVANIA RAILROAD (cont'd)					
Pittsburgh Region (cont'd)					
234	H-9	Shaft	Johnstown Pa.	Haws Refractories	{ 407 Main St., Johnstown Pa.
Sang Hollow Extension					
235	G-8	Diamond Smokeless Nos. 1 & 2	Seward Pa.	Imperial Coal Corp.	Johnstown Pa.
236	G-8	Conemaugh	Seward Pa.	Conemaugh Mining Co.	{ 12800 Shaker Blvd., Cleveland O.
237		Friel No. 6	Bolivar Pa.	Friel Coal Mining Co.	Box 421, Indiana Pa.
Brandenville Branch					
238	H-7	Atlantic No. 2	Atlantic Colliery No. 2 Pa.	Eagle Coal Co.	Greensburg Pa.
Unity Branch					
Lippincott Branch					
239	H-6	Jamison No. 21	Hostetter Pa.	Pittsburgh Consolidation Coal Co.	{ Koppers Bldg., Pittsburgh Pa.
Manor Branch					
240		Junior No. 4	Manor Pa.	J. M. Hall & Son	Delmont Pa.

**GEOGRAPHICAL LIST OF BITUMINOUS COAL MINES ON
THE PENNSYLVANIA RAILROAD AND LATERAL LINES**

**PENNSYLVANIA AND WEST VIRGINIA
EAST OF PITTSBURGH**

INDEX No.	MAP A	MINE	LOCATION OF MINE AT OR NEAR	OPERATOR	P. O. ADDRESS
PENNSYLVANIA RAILROAD (cont'd)					
Pittsburgh Region (cont'd)					
Turtle Creek Branch					
241	G-5	Poole No. 3	Export Pa.	Poole Coal Co.	Delmont Pa.
242	G-6	Seanor-Loyal	Slickville Pa.	Seanor Coal Corp.	Saltsburg Pa.
Southwest Branch					
Radebaugh Branch					
Hempfield Branch					
Adamsburg Branch					
243	H-5	Adamsburg	Eisaman Pa.	Adamsburg Coal Co.	Adamsburg Pa.
244	H-4	Marchand	Gratztown Pa.	S. & U. Coal Co.	Box 297, Wyland Pa.
Yukon Branch					
245	I-5	Ella	Hunker Pa.	Ella Coal Co.	Greensburg Pa.
246	I-5	Webco	Hunker Pa.	Webco Coal Co.	Box 2, Hunker Pa.
247	I-5	Delmont No. 10	Yukon Pa.	Delmont Fuel Co.	{ Coulter Building, Greensburg Pa.
248	H-4	Hutchinson	Hutchinson Pa.	Westmoreland Coal Co. (General Coal Co.)	{ Fidelity-Phila. Trust Bldg., Phila. Pa. P. O. Box 31, Hunker Pa. Star Jct. Pa.
249	I-5	Susan	Hunker Pa.	Maldenack Coal Co.	
250		Nassar	Connellsville Pa.	Nassar Coal Co.	
Peters Creek Branch					
251		Piney Fork	Large Pa.	Peters Creek Coal Co.	{ Grant Bldg., Pittsburgh Pa. 107 Glenburn Dr., Pittsburgh Pa. Library Pa.
252		Elrama	Elrama Pa.	Snyder Coal Co.	
253	I-3	Mathies	Courtney Pa.	Mathies Coal Co.	
Ellsworth Branch					
254	I-3	Gibson	Bentleyville Pa.	Island Coal Co.	Uniontown Pa.
255	I-3	Bethlehem No. 51	Ellsworth Pa.	Bethlehem Mines Corp. (Bethlehem Steel Co.)	Bethlehem Pa.
Cokesburg Branch					
256	I-3	Bethlehem No. 60	Ellsworth Pa.	Bethlehem Mines Corp. (Bethlehem Steel Co.)	Bethlehem Pa.
Ontario Branch					
257	I-3	Ontario	Cokesburg Pa.	Ontario Mining Co.	Eighty Four Pa.
258	J-2	Bethlehem No. 58	Marianna Pa.	Bethlehem Mines Corp. (Bethlehem Steel Co.)	Bethlehem Pa.
259	I-4	Black Diamond	Monongahela Pa.	J. H. Hillman & Sons Co.	{ Grant Bldg., Pittsburgh Pa.
260	J-3	Vesta Nos. 4 & 5	California Pa.	Jones & Laughlin Steel Corp.	California Pa.
Redstone Branch					
261	J-4	Colonial	Grindstone Pa.	United States Steel Corp.	{ 525 Wm. Penn Place, Pittsburgh Pa.
Vance Mill Branch					
262	J-5	Leisenring No. 3	Bute Pa.	United States Steel Corp.	{ 525 Wm. Penn Place, Pittsburgh Pa.
263	J-5	Leisenring No. 2	Bute Pa.	United States Steel Corp.	{ 525 Wm. Penn Place, Pittsburgh Pa.
264		South Union No. 1	Uniontown Pa.	C. B. Marucci	{ 53 Connellsville St., Uniontown Pa.
265	J-3	Clyde No. 1	Fredericktown Pa.	Republic Steel Corp.	{ Republic Building, Cleveland O.
MONONGAHELA RAILWAY					
266	J-3	Bridgeport No. 1	South Brownsville Pa.	United States Steel Corp.	{ 525 Wm. Penn Place, Pittsburgh Pa.
267	J-3	Maxwell	Maxwell Pa.	United States Steel Corp.	{ 525 Wm. Penn Place, Pittsburgh Pa.
268	J-3	Vesta Coal Preparation Plant	La Belle Pa.	Jones & Laughlin Steel Corp.	California Pa.
269	J-3	Isabella Works	Isabella Pa.	Weirton Steel Co.	Isabella Pa.
270	K-3	Palmer	Antram Pa.	United States Steel Corp.	{ 525 Wm. Penn Place, Pittsburgh Pa.
271	K-3	Ronco	Ronco Pa.	United States Steel Corp.	{ 525 Wm. Penn Place, Pittsburgh Pa.

Commercial reproduction prohibited

Downloaded from http://PRR.Railfan.net/documents

Scanned by Rob Schoenberg, ©2010

**GEOGRAPHICAL LIST OF BITUMINOUS COAL MINES ON
THE PENNSYLVANIA RAILROAD AND LATERAL LINES**

**PENNSYLVANIA AND WEST VIRGINIA
EAST OF PITTSBURGH**

INDEX No.	MAP A	MINE	LOCATION OF MINE AT OR NEAR	OPERATOR	P. O. ADDRESS
MONONGAHELA RAILWAY (cont'd)					
272	K-4	Cats Run Branch Fort	Ifield Pa.	Fort Mason Coal Mining Co.	Masontown Pa. Box 243, Uniontown Pa.
273	K-4	C. H. Baker Siding	Ifield Pa.	C. H. Baker	{ 97 East Main St., Uniontown Pa.
274	K-3	Donald No. 2	Grays Landing ... Pa.	Bridgeview Coal Co.	{ 306 North Main St., Masontown Pa.
275	K-3	Eagle No. 1	Martin Pa.	Jem Coal Co.	Masontown Pa.
276	K-3	Sunshine No. 2	Martin Pa.	George, A.	Morgantown W. Va.
277	K-4	New Geneva	New Geneva ... Pa.	Lake Lynn Fuel Co.	Morgantown W. Va.
278	L-3	Amore	New Geneva ... Pa.	Lake Lynn Fuel Co.	Morgantown W. Va.
279	L-3	Poland No. 3	Poland Pa.	J. H. Hillman & Sons Co.	{ Grant Bldg., Pitts- burgh Pa.
280	L-3	Maple No. 3	Poland Pa.	Whiteley Mining Co.	{ Mt. Pleasant Pa. Box 676, Morgan- town W. Va.
281	L-3	Rosedale No. 7	Poland Pa.	Mon. Valley C. & L. Co.	{ Grant Bldg., Pitts- burgh Pa.
282	L-3	Poland No. 4	Poland Pa.	J. H. Hillman & Sons Co.	{ Grant Bldg., Pitts- burgh Pa.
283	L-3	Poland No. 5	Poland Pa.	J. H. Hillman & Sons Co.	{ Grant Bldg., Pitts- burgh Pa.
284	L-3	Shannopin	Poland Pa.	Jones & Laughlin Steel Corp.	California Pa.
285	L-3	Dilliner	Dilliner Pa.	Lake Lynn Fuel Co.	Morgantown W. Va.
286	L-3	Camp Run	Dilliner Pa.	Caro Coal Co.	Point Marion Pa.
287	L-3	Rosedale No. 3	West Van Voorhis W. Va.	Rosedale Coal Co.	Morgantown W. Va.
288	L-3	Rosedale No. 1-S	West Van Voorhis W. Va.	Rosedale Coal Co.	Morgantown W. Va.
289	L-3	Rosedale No. 1	Maidsville W. Va.	Rosedale Coal Co.	Morgantown W. Va.
290	L-3	Maiden	Maidsville W. Va.	Valley Camp Coal Co.	Morgantown W. Va.
291	L-3	Robinson Run	Maidsville W. Va.	Enrico Deprospero Coal Co.	{ Box 2188, Morgan- town W. Va.
292	L-3	Eldridge No. 3	Maidsville W. Va.	Elizabeth Coal Co.	{ Box 954, Morgantown W. Va.
Scotts Run Branch					
293	L-3	Stewart	Osage W. Va.	Enrico Coal Co.	{ Box 2188, Morgantown W. Va.
294	L-3	Pursglove No. 15	Pursglove W. Va.	Christopher Coal Co.	Box 100, Osage W. Va.
295	L-3	Pursglove No. 8	Pursglove W. Va.	Christopher Coal Co.	Box 100, Osage W. Va.
296	L-3	Bunker	Cassville W. Va.	Trotter Coal Co.	{ Box 859, Morgan- town W. Va.
297	L-2	Brock No. 4	Cassville W. Va.	Christopher Coal Co.	Box 100, Osage W. Va.
298	L-3	Arkwright	Granville W. Va.	Christopher Coal Co.	Box 100, Osage W. Va.
299	L-3	Eldridge No. 2	Granville W. Va.	Elizabeth Coal Co.	{ P. O. Box 954, Morgantown W. Va.
300	M-3	Lynn	Morgantown W. Va.	Lake Lynn Fuel Co.	Morgantown W. Va.
301	M-3	Provins	Morgantown W. Va.	Yale Mining Co.	Morgantown W. Va.
302	M-3	Martha	Morgantown W. Va.	L. & W. Coal Co.	{ 7 Woodlawn Ave., Uniontown Pa.
303	M-3	Keener-Baker	Morgantown W. Va.	Hall Coal Co.	Morgantown W. Va.
304	M-3	Airport	Morgantown W. Va.	Davies Coal Co.	Morgantown W. Va.
305	M-3	Baker Ridge Mine	Morgantown W. Va.	Baker Ridge Coal Co.	{ 816 Madison Ave., Morgantown W. Va.
306	M-3	Lucille No. 2	Morgantown W. Va.	Cherry Hill Coal Co.	Morgantown W. Va.
307	M-3	Mason Dixon No. 1	Morgantown W. Va.	L. & W. Coal Co.	{ 7 Woodlawn Ave., Uniontown Pa.
308	M-3	Ridge	Morgantown W. Va.	Ogden Coal-Iron-Metal Co.	Morgantown W. Va.
309	M-3	Virginia	Morgantown W. Va.	W. L. Pursglove Coal Sales	Morgantown W. Va.
310	M-3	Fox	Morgantown W. Va.	Fox Coal Co.	{ Box 353, Morgan- town W. Va.
311	M-3	Ellis	Morgantown W. Va.	R. H. McLain Coals	{ Box 663, Morgan- town W. Va.
312	M-3	Eldridge No. 1	Morgantown W. Va.	Elizabeth Coal Co.	{ Box 954, Morgan- town W. Va.

Commercial reproduction prohibited
Downloaded from http://PRR.Railfan.net/documents
Scanned by Rob Schoenberg, ©2010

GEOGRAPHICAL LIST OF BITUMINOUS COAL MINES ON THE PENNSYLVANIA RAILROAD AND LATERAL LINES

PENNSYLVANIA AND WEST VIRGINIA EAST OF PITTSBURGH

INDEX No.	MAP A	MINE	LOCATION OF MINE AT OR NEAR	OPERATOR	P. O. ADDRESS
MONONGAHELA RAILWAY (cont'd)					
313	M-3	Gabbert	Hildebrand .. W. Va.	Oak Coal Co.	{ Route 2, Morgan- town .. W. Va.
314	M-3	Christopher No. 5	National .. W. Va.	Locksley Fuel Corp.	{ Box 847, Morgan- town .. W. Va.
315	M-3	Booth No. 6	Edna .. W. Va.	Christopher Coal Co.	Box 100, Osage .. W. Va.
316	M-3	South Union No. 11	Edna .. W. Va.	South Union Coal Co.	Edna .. W. Va.
Indian Creek Branch					
317	M-3	Eleanor	Lowville .. W. Va.	Klink Coal Co.	Point Marion .. Pa.
318	M-3	Indian	Lowville .. W. Va.	Preston By-Products Coal Co.	{ Box 828, Morgantown .. W. Va.
319	M-3	Consolidation No. 93	Byrne .. W. Va.	Consolidation Coal Co. (W. Va.) ..	Fairmont .. W. Va.
320	M-3	Byrne	Byrne .. W. Va.	Konya Coal Co.	Rivesville .. W. Va.
Rivesville Branch					
321	M-3	Morgan	Rivesville .. W. Va.	Virginia & Pittsburgh Coal Co.	Fairmont .. W. Va.
Paw Paw Branch					
322	M-2	Federal	Grant Town .. W. Va.	Eastern Gas & Fuel Assoc. (Coal Division) ..	{ Koppers Bldg., Pitts- burgh .. Pa.
323	M-2	Loveridge Mine (Fairview)	Loveridge Mine (Fairview) .. W. Va.	Pittsburgh Consolidation Coal Co.	{ Koppers Bldg., Pitts- burgh .. Pa.
Ten Mile Run Branch					
324	J-3	Clyde No. 2	Besco .. Pa.	J. H. Hillman & Sons Co..	{ Grant Bldg., Pittsburgh .. Pa.
325	J-3	Clyde No. 3	Clyde No. 3 .. Pa.	Republic Steel Corp ..	{ Republic Bldg., Cleveland .. O.
326	J-3	Emerald No. 2	Clarksville .. Pa.	Emerald Coal & Coke Co.	{ Grant Bldg., Pitts- burgh .. Pa.
327	J-3	Mather	Mather .. Pa.	Pickands Mather ..	{ 2000 Union Commerce Bldg., Cleveland .. O.
Nemacolin Branch					
328	J-3	Emerald No. 1	Rice's Landing .. Pa.	Emerald Coal & Coke Co.	{ Grant Bldg., Pitts- burgh .. Pa.
329	K-3	Crucible	Crucible .. Pa.	Crucible Fuel Co.	{ Oliver Bldg., Pittsburgh .. Pa.
330	K-3	Nemacolin	Nemacolin .. Pa.	Buckeye Coal Co.	{ Stambaugh Bldg., Youngstown .. O.
331	K-4	Footedale	Footedale .. Pa.	Menallen Coke Co.	{ P. O. Box 42, New Salem .. Pa.
332	K-4	Hoover No. 2	Ache .. Pa.	Pennsylvania Coal Co. ..	Uniontown .. Pa.
333	K-4	Hoover No. 1	Ache .. Pa.	Pennsylvania Coal Co. ..	Uniontown .. Pa.
334	K-4	Guseman Works	Ache .. Pa.	Guseman Bros. Coal Co..	{ 113 Main St., Union- town .. Pa.
335	K-4	Puritan No. 1	Ache .. Pa.	Leckrone Coal & Coke Co.	McClellandtown .. Pa.
SMITHFIELD & MASONTOWN BRANCH					
336	K-4	Collier	Collier .. Pa.	United States Steel Corp.	{ 525 Wm. Penn Place, Pittsburgh .. Pa.
337	K-4	Daugherty No. 2	Smithfield .. Pa.	Bortz Coal Co.	Uniontown .. Pa.
PENNSYLVANIA RAILROAD (cont'd)					
Pittsburgh Region (cont'd)					
Indiana Branch					
338	F-7	Graceton No. 3	Graceton .. Pa.	Coal Mng. Co. of Grace- ton, Inc.	Graceton .. Pa.
Yellow Creek Branch					
339	F-8	Lucerne	Homer City .. Pa.	Rochester & Pittsburgh Coal Co.	Indiana .. Pa.
340		Ragalini	Homer City .. Pa.	Joseph Ragalini	Homer City .. Pa.
341	F-8	Appalacha	Homer City .. Pa.	Appalacha Coal Co.	Box 51, Indiana .. Pa.
342	F-7	Krolic No. 1	Homer City .. Pa.	Krolick Coal Co.	Dixonville .. Pa.
343	F-7	Dutch Run	Indiana .. Pa.	Kimmel Coal Co.	Shelocta .. Pa.
344	E-7	Ernest Nos. 1 and 2	Ernest .. Pa.	Rochester & Pittsburgh Coal Co.	Indiana .. Pa.
345	F-7	Kent Nos. 1 and 2	McIntyre .. Pa.	Rochester & Pittsburgh Coal Co.	Indiana .. Pa.

**GEOGRAPHICAL LIST OF BITUMINOUS COAL MINES ON
THE PENNSYLVANIA RAILROAD AND LATERAL LINES**

**PENNSYLVANIA AND WEST VIRGINIA
EAST OF PITTSBURGH**

INDEX No.	MAP A	MINE	LOCATION OF MINE AT OR NEAR	OPERATOR	P. O. ADDRESS
		PENNSYLVANIA RAILROAD (cont'd)			
		Pittsburgh Region (cont'd)			
		Indiana Branch (cont'd)			
346	F-7	Kent Nos. 3 and 4	Coal Run Pa.	Rochester & Pittsburgh Coal Co.	Indiana Pa.
347	G-6	Bowman	Tunnelton Pa.	Bowman Coal Co.	Leechburg Pa.
348	G-6	Watson	White Pa.	Rochester & Pittsburgh Coal Co.	Indiana Pa.
349		Conrad	Saltsburg Pa.	Conrad Coal Co.	Saltsburg Pa.
		Apollo Branch			
350	F-5	Cassella	Apollo Pa.	Cassella Coal Co.	Box 405, Apollo Pa.
351	F-5	Mateer	Apollo Pa.	Mateer Coal Co.	446 Canal St., Leechburg Pa.
352	F-5	Marco	Apollo Pa.	Marco Coal Co.	Box 457, Apollo Pa.
353		Altmire	Apollo Pa.	Altmire Bros. Coal Co.	Vandergrift Pa.
354	F-5	Cherry Run	Apollo Pa.	Altmire Bros. Coal Co.	Vandergrift Pa.
355	F-6	Relco	Apollo Pa.	Altmire Bros. Coal Co.	Vandergrift Pa.
356	F-6	Foster Nos. 4 & 5	Apollo Pa.	Leechburg Mining Co.	Leechburg Pa.
357	F-6	June	Apollo Pa.	Altmire Bros. Coal Co.	Vandergrift Pa.
358	F-5	Beck	Apollo Pa.	Altmire Bros. Coal Co.	Vandergrift Pa.
359	F-5	Bleriot	Vandergrift Pa.	Altmire Bros. Coal Co.	Vandergrift Pa.
360	F-5	Lewis	Vandergrift Pa.	Pine Run Co.	Leechburg Pa.
		Schenley Branch			
361	F-5	Park	Leechburg Pa.	Park Coal Co.	Leechburg Pa.
362	E-5	Venturini	Kiskiminetas Jct. Pa.	Venturini Bros.	Leechburg Pa.
		Butler Branch			
363	E-5	Butler Junction	Lane Pa.	Butler Junction Coal Co.	Leechburg Pa.
364	F-4	Harmar	Harmarville Pa.	Harmar Coal Co.	Harmarville Pa.
		CHESWICK & HARMAR RAILROAD			
365	F-4	Harwick	Cheswick Pa.	Duquesne Light Co.	Pittsburgh Pa.
		UNITY RAILWAYS			
366	G-4	Renton No. 3	Renton Pa.	Pittsburgh Coal Co.	Library Pa.
		PENNSYLVANIA RAILROAD (cont'd)			
		Pittsburgh Region (cont'd)			
		Plum Creek Branch			
367	G-4	Newfield	Unity Pa.	Republic Steel Corp.	{ Republic Building, Cleveland O.
368	F-4	Oakmont	Barking Pa.	Harmar Coal Co.	Harmarville Pa.
369	D-5	Decker No. 2	Kittanning Pa.	Powell Coal Co.	{ R. D. No. 2, Kittanning Pa.
370		Garrett Run	Kittanning Pa.	B. & V. Coal Co.	{ 1303 Airport Road, R. D. No. 6, Pittsburgh 27 Pa.
371	D-6	Mosgrove	Mosgrove Pa.	Wallwork Coal Co.	Summerville Pa.
		Northern Region			
372	C-5	Dutch Hill	Sarah Furnace Pa.	Dutch Hill Coal Co.	Kittanning Pa.
373		Hillcrest	Foxburg Pa.	Hillcrest Mining Co.	Foxburg Pa.
		Low Grade Branch			
		Sligo Branch			
374		Fenton No. 2	Rimersburg Pa.	C. H. & R. Coal Co.	Rimersburg Pa.
375		Fox	Rimersburg Pa.	H. M. McNutt Coal Co.	{ P. O. Box 8, Rimersburg Pa.
376		Mac No. 1	Rimersburg Pa.	Mac Coal Co.	Sligo Pa.
377		Amos No. 6	Huey Pa.	C. L. Amos Coal Corp.	{ 220 East Washington St., Syracuse 1 N. Y.
378		Huey	Sligo Pa.	G. A. Stiles Coal Co.	Tylersburg Pa.
379		Allison No. 12	Sligo Pa.	Allison Engr. Co.	Allison Park Pa.
380		West Freedom Nos. 1 & 2	Sligo Pa.	West Freedom Mining Co.	4 Glass St., Carnegie Pa.
381		Lloyd No. 3	Sligo Pa.	Wingert Contracting Co.	Butler Pa.
		Bostonia Branch			
382		Bostonia No. 1	New Bethlehem Pa.	New Bethlehem Contr. Co.	New Bethlehem Pa.
383		Sherman No. 5	New Bethlehem Pa.	Jos. F. Sherman Co.	Hawthorn Pa.
384		Iseman No. 2	New Bethlehem Pa.	Iseman Bros.	New Bethlehem Pa.

**GEOGRAPHICAL LIST OF BITUMINOUS COAL MINES ON
THE PENNSYLVANIA RAILROAD AND LATERAL LINES
PENNSYLVANIA AND WEST VIRGINIA
EAST OF PITTSBURGH**

INDEX No.	MAP A	MINE	LOCATION OF MINE AT OR NEAR	OPERATOR	P. O. ADDRESS
PENNSYLVANIA RAILROAD (cont'd)					
Northern Region (cont'd)					
Low Grade Branch (cont'd)					
385		Wallwork No. 1	Hawthorn Pa.	Braugler & Dinger	New Berhlehem Pa.
386		Sherman No. 2	Hawthorn Pa.	Jos. F. Sherman Co.	Hawthorn Pa.
387		Taylor	Hawthorn Pa.	Taylor Bros.	Hawthorn Pa.
388		Caltagrone	Fuller Pa.	Paul Caltagrone	Fuller Pa.
389		O'Harran	Reynoldsville Pa.	O'Harran Mng. Co.	Reynoldsville Pa.
390		Callahan	Reynoldsville Pa.	Callahan Coal Co.	Reynoldsville Pa.
391	B-9	Spencer & Mauk	Reynoldsville Pa.	Anita Coal Mining Co.	Punxsutawney Pa.
392		McClure	Reynoldsville Pa.	McClure Coal Co.	Reynoldsville Pa.
393		Minns	Falls Creek Pa.	Minns Bros.	Du Bois Pa.
394		McIntosh No. 2	Du Bois Pa.	McIntosh Coal Co.	Du Bois Pa.
395	B-9	Clear Run	Du Bois Pa.	Green Glen Corp.	Du Bois Pa.
396	A-10	Tyler No. 14	Tyler Pa.	Underhill Coal Mining Co.	St. Mary's Pa.
397		Proctor No. 3	Tyler Pa.	New Shawmut Mng. Co.	St. Mary's Pa.
398		P. & N. No. 2	Medix Run Pa.	P. & N. Coal Co.	Punxsutawney Pa.
Ridgeway Branch					
399	A-10	Bernadine No. 1	Brockway Pa.	J. R. Dambacher	Ridgeway Pa.
400		Brandy Camp No. 5	Brockway Pa.	New Shawmut Mng. Co.	St. Mary's Pa.
401		Frances-Leo	Brockway Pa.	Brockway Fuel Co.	Brockway Pa.
402		Westport	Westport Pa.	D. G. Wertz Coal Co.	Greensburg Pa.
403		Sterling Run	Sterling Run Pa.	John E. Rydesky	Emporium Pa.
404		P. & K.	Keating Summit Pa.	P. & K. Inc.	Port Allegany Pa.
LAKE ERIE, FRANKLIN & CLARION R. R.					
405		Stahlman No. 1	Holden Pa.	Stahlman Coal Co.	Corsica Pa.
406		Stahlman No. 2	Holden Pa.	Stahlman Coal Co.	Corsica Pa.
407		P. & G.	Holden Pa.	P. & G. Coal Co.	Holden Pa.
408		Du Bois No. 3 (Elba)	Strattonville Pa.	Du Bois Coal Mining Co.	Brookville Pa.
409		Fisher	Strattonville Pa.	P. & G. Coal Co.	Holden Pa.
410		Henderson	Strattonville Pa.	Valley Coal Co.	Brockway Pa.
WESTERN ALLEGHENY RAILROAD					
411	C-3	Egal	Queen Jct. Pa.	Craig G. Saul	R. D. No. 5, Butler Pa.
412		Mahood No. 4	Queen Jct. Pa.	Major I. Reeves	R. D. No. 2, Chicora Pa.
413		Sunbeam	Hooker Pa.	Sunbeam Coal Co.	North Washington Pa.
414		Edwin W. Toy	Hooker Pa.	Edwin W. Toy	{ R. D. No. 3, Kittanning Pa.
415	C-4	Kincaid	Fairmont Pa.	Grubbs Construction Co.	Karns City Pa.
416		Toy No. 10	Blacksburg Pa.	P. L. Toy Coal Co.	Box 169, Kittanning Pa.
417		Harcliff No. 1	East Brady Pa.	Harcliff Coal Co.	{ Oliver Bldg., Pittsburgh Pa.
418		Heffelfinger	Kaylor Pa.	Heffelfinger Coal Co.	Cowansville Pa.
PITTSBURGH & WEST VIRGINIA RY.					
419		Alice No. 2	Large Pa.	Apex Coal Co., Inc.	{ Fourth & Border Sts., West Elizabeth Pa.
420	H-4	Alice No. 1	Clairton Pa.	Glass Run Coal Co.	{ P. O. Box 115, Wilson Sta., Clairton Pa.
421		Penn No. 3	Connellsville Pa.	J. E. Cravotta	{ 14 South Keesey St., York Pa.
422		Rich Hill	Connellsville Pa.	Pittsburgh & Fairmont Coal Co.	{ First National Bank Bldg., Pittsburgh Pa.

Commercial reproduction prohibited
Downloaded from http://PRR.Railfan.net/documents
Scanned by Rob Schoenberg, ©2010

SOUTH AMBOY, NEW YORK HARBOR

Tidewater Coal Dumping Facilities



This pier is conveniently located to serve the entire New York Harbor territory, with ample harbor facilities to accommodate an unlimited number of boats.

The facilities consist of two McMyler car dumpers with a combined capacity of 40,000 tons per day (24 hours). Mechanical devices are provided for the trimming of cargo in barges and other vessels.

Sufficient depth of water is maintained to accommodate vessels drawing not in excess of 25 feet of water.

Thawing plant facilities are also provided for thawing coal during extremely cold weather, with 86 car capacity.

Ample and conveniently located supporting track facilities are also available to make possible the most rapid movement of loaded cars to the dumpers.

Dimensions and gross weight of cars which can be handled over these dumpers are:

	Maximum Length Over Couplers	Maximum Height	Minimum Height	Maximum Width	Maximum Gross Weight
No. 1 Machine	45'0"	11'4"	6'6"	10'5"	225,000 lbs.
No. 2 Machine	49'0"	12'0"	6'6"	10'6"	225,000 lbs.

MAIL ADDRESS:
 Agent, Howard P. Johnson,
 South Amboy Coal Piers,
 South Amboy, N. J.
 Telephone: South Amboy 1-1959

Commercial reproduction prohibited. Downloaded from http://PRR.Railfan.net/documents. Scanned by Rob Schoenberg, ©2010

SODUS POINT, N. Y.

Lake Ontario Coal Dumping Facilities



Sodus Point transshipping facilities are so situated that they can conveniently serve all ports on the Great Lakes and St. Lawrence River.

These facilities consist of a trestle with eight pockets, four on each side, so as to permit more than one vessel to load simultaneously.

The pier is equipped with electrically operated chutes and trimmers that can be regulated, so as to reduce the breakage of coal to a minimum.

The facility is equipped with electrically operated shake

outs to expedite the unloading of extremely fine sizes of coal, thereby facilitating dispatch of vessels.

This pier is capable of handling 20,000 tons per day (24 hours).

There is also provided ample and conveniently located track storage facilities to make possible the most rapid movement of loaded cars to the trestle.

Ample harbor facilities are also available for berthing any number of vessels.

This pier is capable of handling all self-clearing hopper cars.

MAIL ADDRESS: Agent, Pennsylvania Railroad,
Sodus Point, New York
Telephone: Sodus 3551

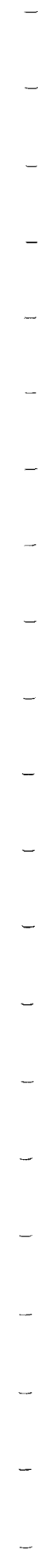

Map A
BITUMINOUS COAL MINES
PENNSYLVANIA AND WEST VIRGINIA
East of Pittsburgh

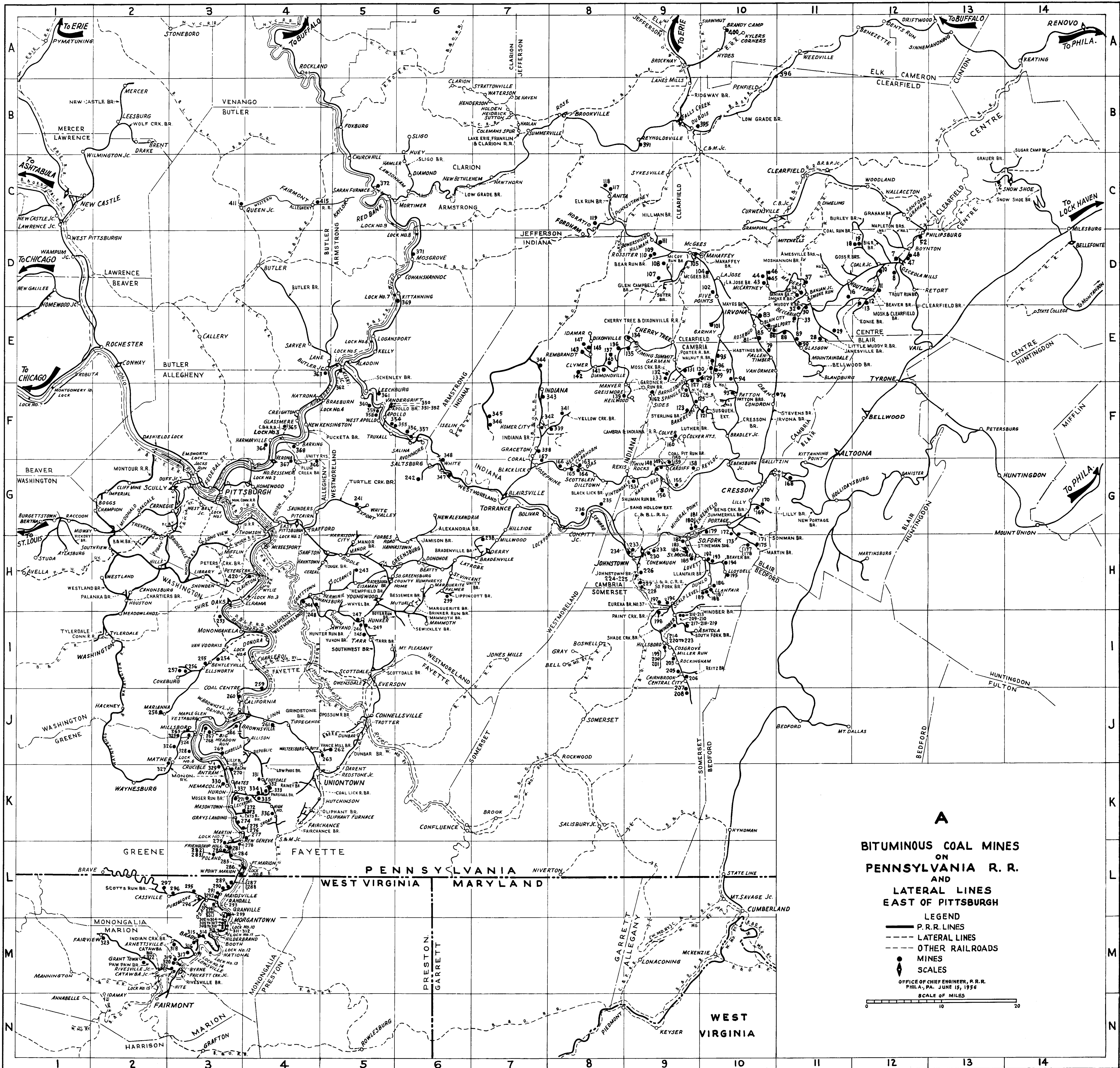

A

**BITUMINOUS COAL MINES
ON
PENNSYLVANIA R. R.
AND
LATERAL LINES
EAST OF PITTSBURGH**

LEGEND

- P. R. R. LINES
- - - LATERAL LINES
- - - OTHER RAILROADS
- MINES
- ⊙ SCALES

OFFICE OF CHIEF ENGINEER, P. R. R.
PHILA., PA. JUNE 19, 1926

SCALE OF MILES

0 10 20

Scanned by Rob Schoenberg, ©2010. Downloaded from http://www.kalifornia.net/documents/

**ALPHABETICAL LIST OF BITUMINOUS COAL MINES ON
THE PENNSYLVANIA RAILROAD AND LATERAL LINES**

**OHIO, PENNSYLVANIA AND WEST VIRGINIA
WEST OF PITTSBURGH**

INDEX No.	MAP B	MINE	STATE	INDEX No.	MAP B	MINE	STATE
3		Aurora	Pa.	25	H-16	Maude	Pa.
2	H-15	Avella Washery	Pa.	44		Meechan	O.
				52		Moore	O.
10	H-13	Betsy No. 1	O.	16	H-16	Morris	Pa.
43		Betsy No. 2	O.				
62		Blue Crystal	O.	31	I-13	Nixon	O.
23		Buckeye	Pa.	37	K-13	Norton No. 3	O.
40		Cadiz	O.	56	J-9	Orchard	O.
33	J-13	Carnegie	O.				
59		Carol No. 2	O.	4		Pea Vine	Pa.
15	G-16	Champion No. 1 Cleaning Plant (Pittsburgh Coal Co. No. 160)	Pa.	51		Pitsy	O.
49		Commander	O.	41	H-12	Pittsburgh Consol. Coal Co. Cleaning & Preparation Plant (Georgetown)	O.
9		Cool Spring	O.	14		Pittsburgh Coal Co. No. 157 (Russell No. 1)	Pa.
				18	H-16	Pittsburgh Coal Co. No. 158	Pa.
22		Dew No. 1	Pa.	15	G-16	Pittsburgh Coal Co. No. 160 (Champion No. 1 Cleaning Plant)	Pa.
30	I-13	Dorothy No. 1	O.	19	H-17	Pittsburgh Coal Co. No. 164	Pa.
8	H-14	Dubena	W. Va.	17	H-16	Pittsburgh Coal Co. No. 167	Pa.
				38		Pond Hollow	O.
60		Elba	O.	21		Portersville	Pa.
61		Electromet	O.	35	K-13	Powhatan Nos. 1 & 2	O.
				34	J-13	Powhatan No. 3	O.
24		Fleck	Pa.	20	G-17	Presto	Pa.
32	I-13	Florence	O.				
26	G-15	Florence	Pa.	13		Rider No. 4	Pa.
27	G-15	Francis	Pa.	14		Russell No. 1 (Pittsburgh Coal Co. No. 157)	Pa.
39		Fulton No. 3	O.				
				7		Sasso No. 1	W. Va.
41	H-12	Georgetown (Pittsburgh Consol. Coal Co. Cleaning & Prep. Plant)	O.	55		Signal	O.
57	J-9	Gill	O.	1		Sihol	Pa.
47	K-6	Golden Oak	O.	5		Speer No. 4	Pa.
				53	F-13	Sterling	O.
29		Half Moon	W. Va.	50		Sunnyhill No. 8	O.
42		Healy No. 1	O.				
11		Hopedale	O.	46	K-6	Ten X	O.
48		Ironspot	O.	58	J-9	Walnut Hill	O.
				6	H-14	Waverly	Pa.
12		Jean No. 1	Pa.	63		Williamson	O.
				45		Willowbrook	O.
36	K-13	Kish	O.	54		Willow Crest	O.
28	G-14	Locust Grove	W. Va.				

**GEOGRAPHICAL LIST OF BITUMINOUS COAL MINES ON
THE PENNSYLVANIA RAILROAD AND LATERAL LINES**

**OHIO, PENNSYLVANIA AND WEST VIRGINIA
WEST OF PITTSBURGH**

INDEX No.	MAP B	MINE	LOCATION OF MINE AT OR NEAR	OPERATOR	P. O. ADDRESS
PITTSBURGH & WEST VIRGINIA RAILWAY					
1		Sihol	Gladden Pa.	Sihol Coal Co.	Bridgeville Pa.
2	H-15	Avella Washery	Acme Pa.	Penowa Coal Co.	Grant Bldg., Pgh. Pa.
3		Aurora	Avella Pa.	United Collieries Co.	Hippodrome Bldg., Clev.O.
4		Pea Vine	Acme Pa.	Clyde E. Speer Coal Co..	Koppers Bldg., Pgh. Pa.
5		Speer No. 4	Avella Pa.	Clyde E. Speer Coal Co..	Koppers Bldg., Pgh. Pa.
6	H-14	Waverly	Penowa Pa.	State Line Coal Co.	Marion Ave., Oakdale.Pa.
7		Sasso No. 1	Virginia W. Va.	Penowa Coal Co.	Grant Bldg., Pgh. Pa.
8	H-14	Dubena	Cliftonville ... W. Va.	Dubena Coal Co.	{ 378 Main St., Follansbee ... W. Va.
9		Cool Spring	Mingo Jct. O.	Brettell Coal Co.	{ 610 Commercial St., Mingo Jct. O.
10	H-13	Betsy No. 1	Smithfield O.	North American Coal Corp.	{ Shaker Square, Shaker Heights O.
11		Hopedale	Wayco O.	Polen Coal Co.	Box 248, Hopedale...O.
MONTOUR RAILROAD					
12		Jean No. 1	Boggs Pa.	North Star Coal Co.	{ Bessemer Bldg., Pittsburgh Pa.
13		Rider No. 4	Boggs Pa.	Wm. Aloe Coal Co.	Imperial Pa.
14		Pittsburgh Coal Co. No. 157 (Russell No. 1)	Champion Pa.	Pittsburgh Coal Co.	Library Pa.
15	G-16	Pittsburgh Coal Co. No. 160 (Champion No. 1 Cleaning Plant)	Champion Pa.	Pittsburgh Coal Co.	Library Pa.
16	H-16	Morris	Southview Pa.	Weise Bros.	{ 627 Oliver Bldg., Pittsburgh Pa.
17	H-16	Pittsburgh Coal Co. No. 167	Southview Pa.	Pittsburgh Coal Co.	Library Pa.
18	H-16	Pittsburgh Coal Co. No. 158	Hyland Pa.	Pittsburgh Coal Co.	Library Pa.
19	H-17	Pittsburgh Coal Co. No. 164	Library Pa.	Pittsburgh Coal Co.	Library Pa.
PITTSBURGH, CHARTIERS & YOUGHIOGHENY RY.					
20	G-17	Presto	Presto Pa.	Jeff Mining Co.	Presto Pa.
PENNSYLVANIA RAILROAD					
Lake Region					
New Castle Branch					
21		Portersville	Leesburg Pa.	Portersville Coal Co.	Clarion Pa.
22		Dew No. 1	Leesburg Pa.	Ivywood Coal Co.	Butler Pa.
23		Buckeye	Houston Jct. Pa.	Buckeye Coal Co.	{ Stambaugh Bldg., Youngstown O.
Pittsburgh Region					
Bridgeville & McDonald Branch					
24		Fleck	Carnegie Pa.	Fleck Bros. Coal Co.	Carnegie Pa.
25	H-16	Maude	Treveskyn Pa.	Chas. E. Campbell	Bridgeville Pa.
26	G-15	Florence	Burgettstown ... Pa.	Harmon Creek Coal Co..	{ 1st National Bank Bldg., Pittsburgh ... Pa.
27	G-15	Francis	Burgettstown ... Pa.	Greenville - Connelsville Coal & Coke Co.	{ Union Trust Bldg., Pittsburgh Pa.
28	G-14	Locust Grove	Collier W. Va.	West Virginia - Pittsburgh Coal Co.	{ 1031 Main St., Wellsburg W. Va.
New Cumberland Branch					
29		Half Moon	Weirton W. Va.	Glen Brooke Coal Co.	{ Box 560, Cove Station, Weirton.W. Va.
River Branch					
Little Short Creek Industrial Track					
30	I-13	Dorothy No. 1	Rayland O.	Youghiogheny & Ohio Coal Co.	{ Hanna Bldg., Cleveland O.
31	I-13	Nixon	Martins Ferry O.	Nixon Run Coal Co.	Martins Ferry O.
32	I-13	Florence	Martins Ferry O.	Youghiogheny & Ohio Coal Co.	{ Hanna Bldg., Cleveland O.

Commercial reproduction prohibited
Downloaded from http://PRR.Railfan.net/documents
Scanned by Rob Schoenberg, ©2010

**GEOGRAPHICAL LIST OF BITUMINOUS COAL MINES ON
THE PENNSYLVANIA RAILROAD AND LATERAL LINES**

**OHIO, PENNSYLVANIA AND WEST VIRGINIA
WEST OF PITTSBURGH**

INDEX No.	MAP B	MINE	LOCATION OF MINE AT OR NEAR	OPERATOR	P. O. ADDRESS	
		PENNSYLVANIA RAILROAD (cont'd)				
		Pittsburgh Region (cont'd)				
		River Branch (cont'd)				
		Little Short Creek Industrial Track (cont'd)				
33	J-13	Carnegie	Bellaire O.	Clean Coal Co.	Bellaire O.	
34	J-13	Powhatan No. 3	Aults O.	Powhatan Mining Co. ..	{ 12800 Shaker Blvd., Cleveland O.	
35	K-13	Powhatan Nos. 1 & 2	Powhatan O.	Powhatan Mining Co. ..	{ 12800 Shaker Blvd., Cleveland O.	
36	K-13	Kish	Powhatan O.	Kish Coal Co.	Powhatan O.	
37	K-13	Norton No. 3	Onco O.	David Z. Norton Co.	{ Hanna Bldg., Cleveland O.	
		Lake Region				
		Tuscarawas Branch				
38		Pond Hollow	Dover O.	Penn Ohio Coal Co.	Dover O.	
		Buckeye Region				
		Cadiz Branch				
39		Fulton No. 3	Narva O.	Powhatan Mng. Co.	{ 12800 Shaker Blvd., Cleveland O.	
40		Cadiz	Cadiz O.	Cadiz Mining Co.	Cadiz O.	
41	H-12	Georgetown (Pittsburgh Consolidation Coal Co.—Coal Cleaning and Preparation Plant)	Georgetown O.	Pittsburgh Consolidation Coal Co. (Hanna Coal Division)	{ Leader Bldg., Cleveland O.	
42		Healy No. 1	Cadiz O.	R. & F. Coal Co.	Box 282, Cadiz O.	
43		Betsy No. 2	Fernwood O.	Powhatan Mng. Co.	{ 12800 Shaker Blvd., Cleveland O.	
44		Meechan	Philadelphia Road .. O.	J. R. Carroll	Philadelphia Road .. O.	
45		Willowbrook	Coshocton O.	Willowbrook Coal Co. ..	{ R. F. D. No. 5, Coshocton O.	
		Zanesville Branch				
46	K-6	Ten X	Roseville O.	Ten X Coal Co.	Roseville O.	
47	K-6	Golden Oak	Roseville O.	National Hocking Coals Inc.	Box 145, Roseville ... O.	
48		Ironspot	Roseville O.	Bruns Coal Co.	{ Lind Arcade, Zanesville O.	
49		Commander	Roseville O.	Bruns Coal Co.	{ Lind Arcade, Zanesville O.	
50		Sunnyhill No. 8	New Lexington ... O.	Sunnyhill Coal Co.	{ 150 East Broad St., Columbus O.	
		Lake Region (cont'd)				
		Pitsy				
		Salineville Railroad				
52		Moore	Salineville O.	W. J. Moore & Son	R. F. D. 3, Warren ... O.	
53	F-13	Sterling	Salineville O.	J. M. Hirst Coal Co.	Salineville O.	
		YOUNGSTOWN & SOUTHERN RAILWAY				
54		Willow Crest	Willow Crest O.	Marshall Mining Co.	{ 512 Union Bank Bldg., Youngstown .. O.	
55		Signal	Signal O.	J. & J. Coal Equipment Co.	Signal O.	
		PENNSYLVANIA RAILROAD (cont'd)				
		Lake Region (cont'd)				
		Marietta Branch				
56	J-9	Orchard	Cambridge O.	Orchard Coal Co.	Cambridge O.	
57	J-9	Gill	Cambridge O.	Yakubisin Coal Co.	{ R. D. 6, Box 45, Cambridge O.	
58	J-9	Walnut Hill	Byesville O.	Hamilton & Trenner Co... ..	{ Route No. 6, Cambridge O.	
59		Carol No. 2	Byesville O.	Virginia Mining Co.	Cambridge O.	
60		Elba	Warner O.	Peaker Run Coal Co.	R. F. D., Elba O.	
61		Electromet	Dexter City O.	Union Carbide & Carbon Co. (Electro Metallurgical Division)	Dexter City O.	
		Buckeye Region				
		Dresden Branch				
62		Blue Crystal	Killbuck O.	Blue Crystal Mines, Inc... ..	Millersburg O.	
63		Williamson	Blissfield O.	H. D. Williamson	Millersburg O.	

Commercial reproduction prohibited
Downloaded from http://PRR.Railfan.net/documents
Scanned by Rob Schoenberg, ©2010

VERNER DOCK – PITTSBURGH (JACKS RUN), PA.
Ohio River Coal Dumping Facilities

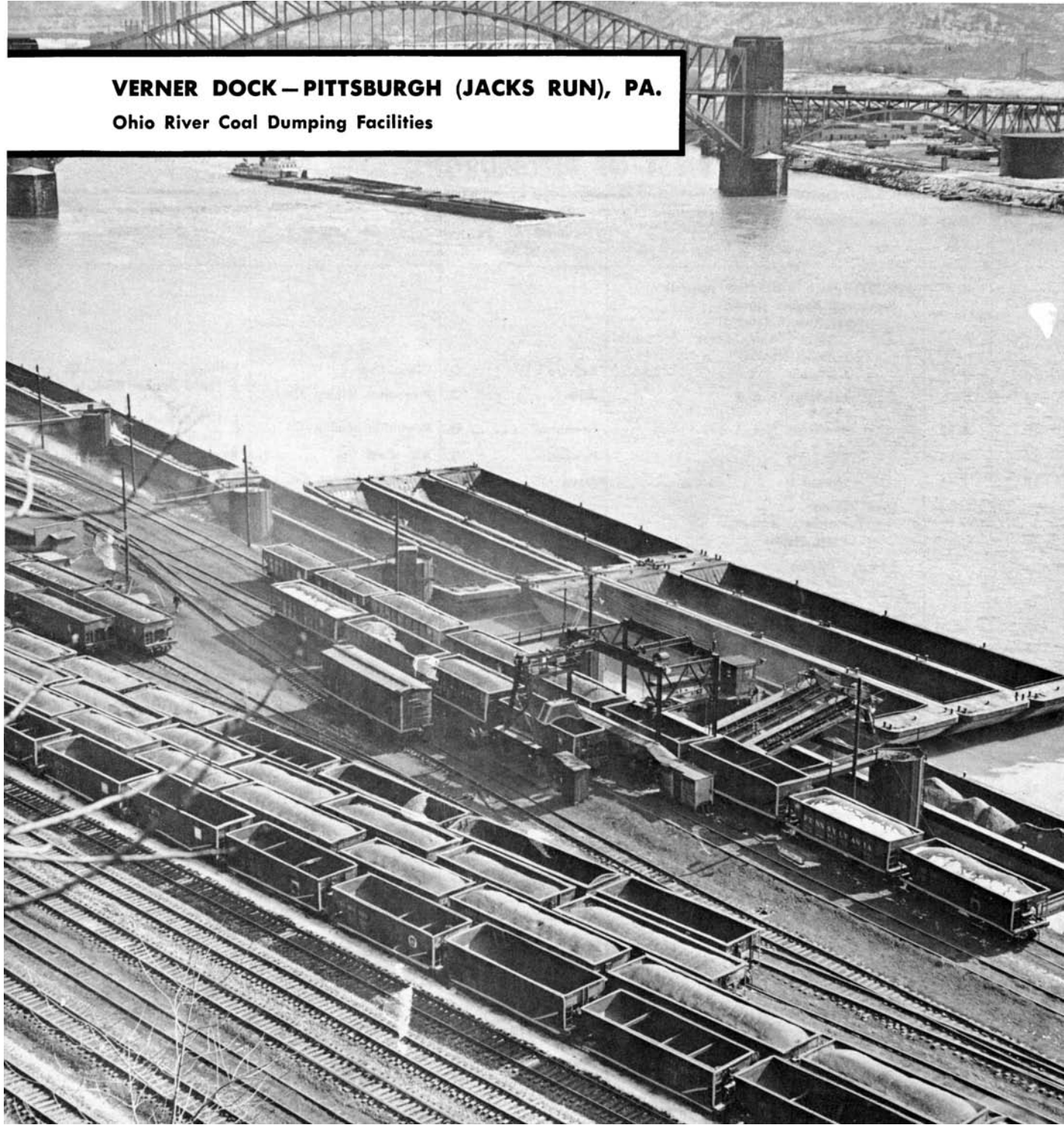

This facility located on the Ohio River 3.6 miles west of the "point" consists of two hoppers equipped with Shake-outs and electrically operated conveyor belts for transferring coal from cars to barges.

This dock is capable of handling 8,000 tons per day (24 hours).

All self-clearing hopper cars can be handled at this facility.

MAIL ADDRESS:

Agent,
Pennsylvania Railroad Company,
Federal Street,
Pittsburgh, Pa.

CONWAY COAL DOCK — CONWAY, PA.
Ohio River Coal Transfer Facilities (Barges to Cars)

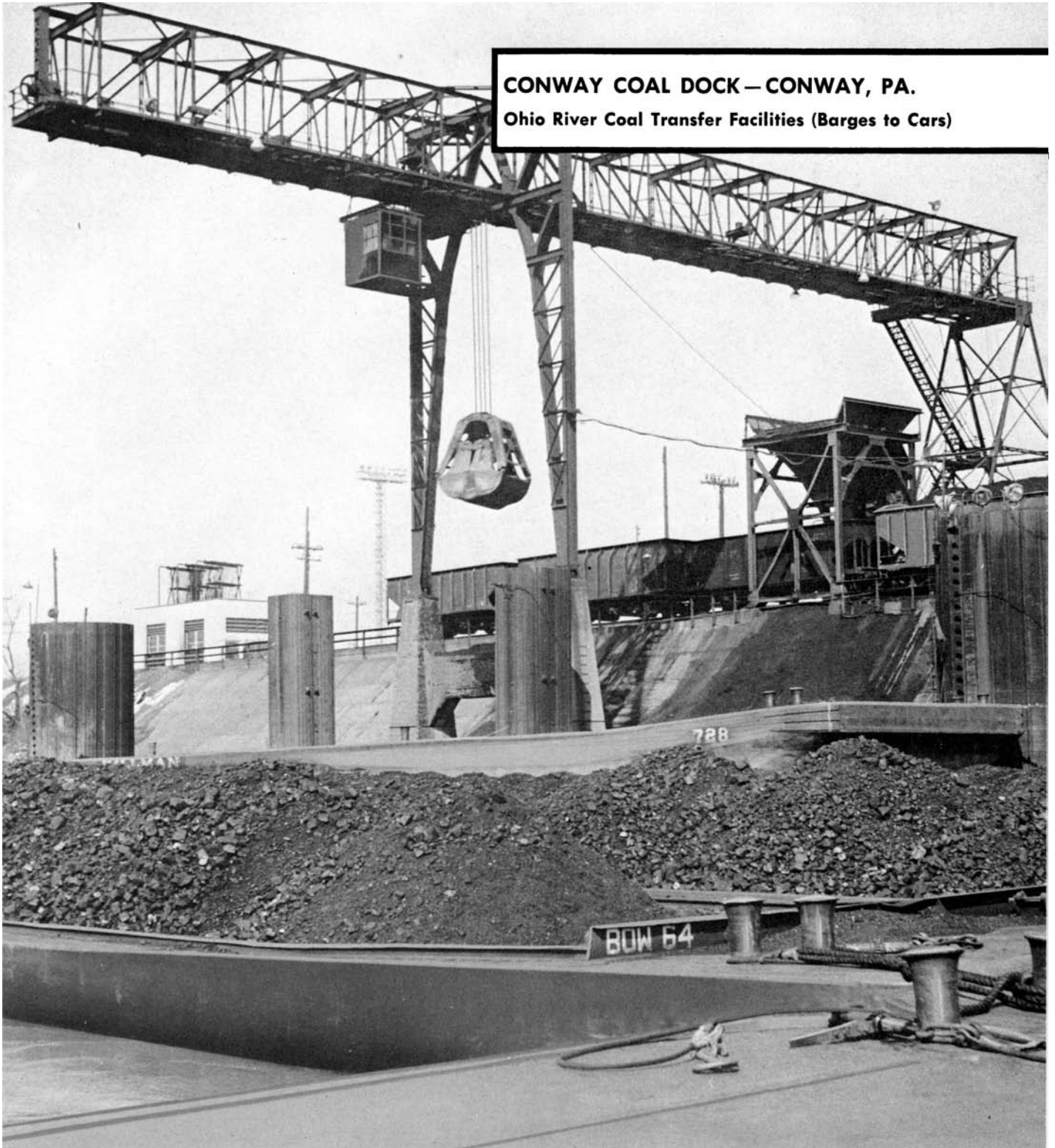

This Dock is located adjacent to the new Conway Yard. The facilities include one Dravo Whirler and one Heyl & Patterson Straight Line Machine with a combined capacity of 8,500 tons per day (24 hours).

Track Scales are located immediately adjacent to the dock.

MAIL ADDRESS:

J. P. Carr,
General Foreman,
P. R. R. Engine House,
Conway, Pa.

Map B
BITUMINOUS COAL MINES
OHIO, PENNSYLVANIA AND WEST VIRGINIA
West of Pittsburgh

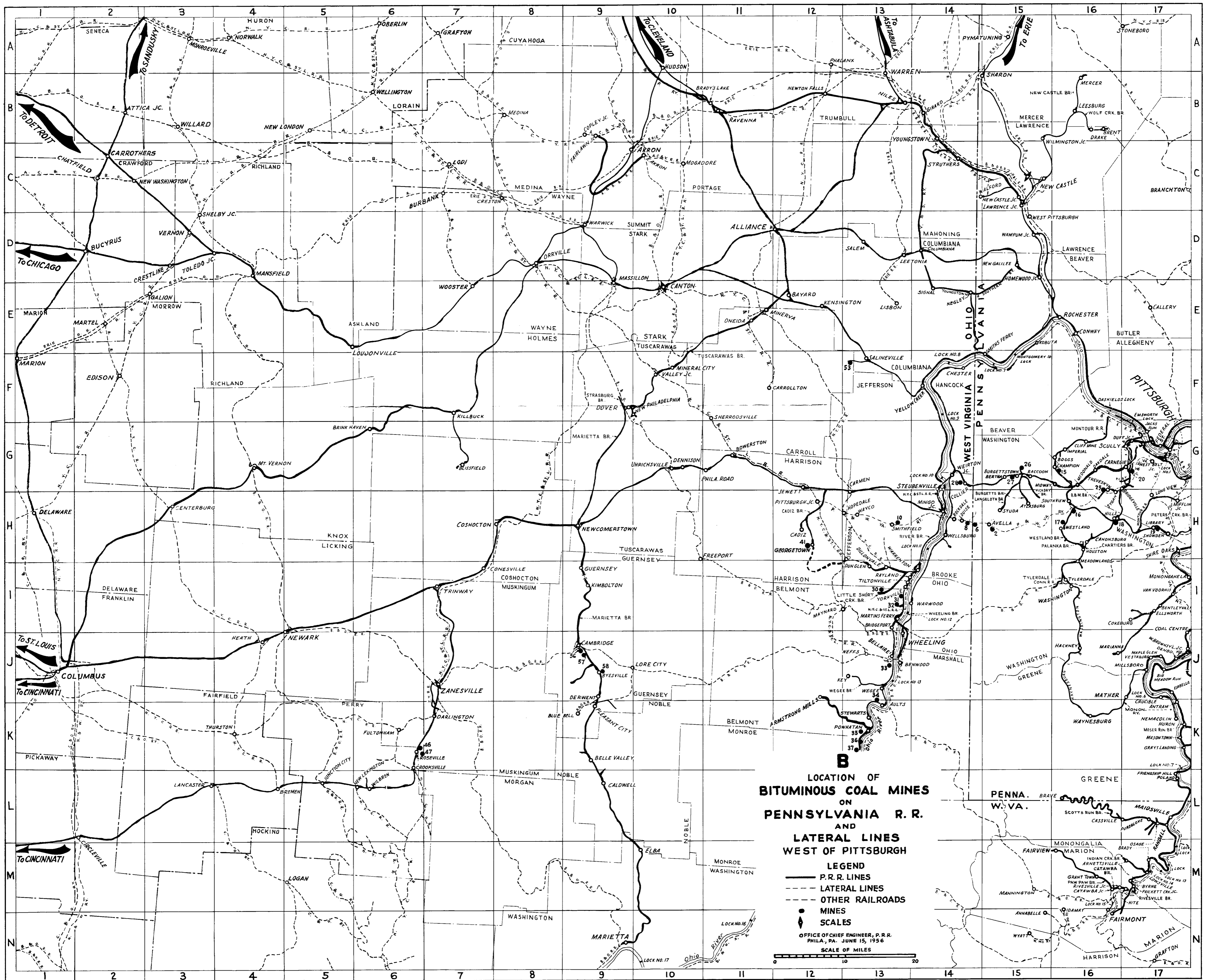

B
LOCATION OF
BITUMINOUS COAL MINES
ON
PENNSYLVANIA R. R.
AND
LATERAL LINES
WEST OF PITTSBURGH

LEGEND
— P.R.R. LINES
- - - LATERAL LINES
· · · OTHER RAILROADS
● MINES
○ SCALES

OFFICE OF CHIEF ENGINEER, P.R.R.
PHILA., PA. JUNE 15, 1956
SCALE OF MILES

0 10 20

CLEVELAND DOCK, CLEVELAND, OHIO

Lake Erie Coal Dumping Facilities



This dock is equipped with a Wellman-Seaver-Morgan type car dumper with gates on the telescope, sprinkling system, and retarder on the pan to assure careful and efficient handling of the coal. It has a dumping capacity of 40,000 tons per day (24 hours).

All boats have easy access to the slip which is 855 feet

in length, and is protected by a government break wall. The depth of water, 25 feet, is sufficient to accommodate the largest boats operating on the Lakes.

Available track space back of the machine has a capacity of approximately 475 cars, with supporting yard for 5,000 cars.

Dimensions and gross weight of cars which can be handled over this dumper are:

<i>Maximum Length Over Couplers</i>	<i>Maximum Height</i>	<i>Minimum Height</i>	<i>Maximum Width</i>	<i>Minimum Gross Weight</i>
52'6"	12'0"	6'6"	11'0"	280,000 lbs.

MAIL ADDRESS:
Agent, Pennsylvania Railroad,
1477 Davenport Avenue,
Cleveland 14, Ohio
Telephone: ENdicott 1-2121, Line 291

ERIE DOCKS, ERIE, PA.
Lake Erie Coal Dumping Facilities



These docks are served by a slip 1,200 feet long with depth of water 26 feet.

The facilities consist of a McMyler car dumper equipped with a sprinkling system, and modern telescope gates to assure careful and efficient handling of the coal, with an

average dumping capacity of 36,000 tons per day (24 hours).

The yard serving this machine has a capacity of 200 cars with additional supporting yard facilities for 2,600 cars.

Dimensions and gross weight of cars which can be handled over this dumper are:

<i>Maximum Length Over Couplers</i>	<i>Maximum Height</i>	<i>Minimum Height</i>	<i>Maximum Width</i>	<i>Maximum Gross Weight</i>
48'0"	12'0"	6'6"	10'6"	210,000 lbs.

MAIL ADDRESS:
 Agent, Pennsylvania Railroad,
 P. O. Box 304, Erie, Pa.
 Telephones: { Erie 22541
 Erie 25631

Commercial reproduction prohibited
 Downloaded from http://PRR.Railfan.net/documents
 Scanned by Rob Schoenberg, ©2010

ASHTABULA DOCK, ASHTABULA HARBOR, OHIO

Lake Erie Coal Dumping Facilities

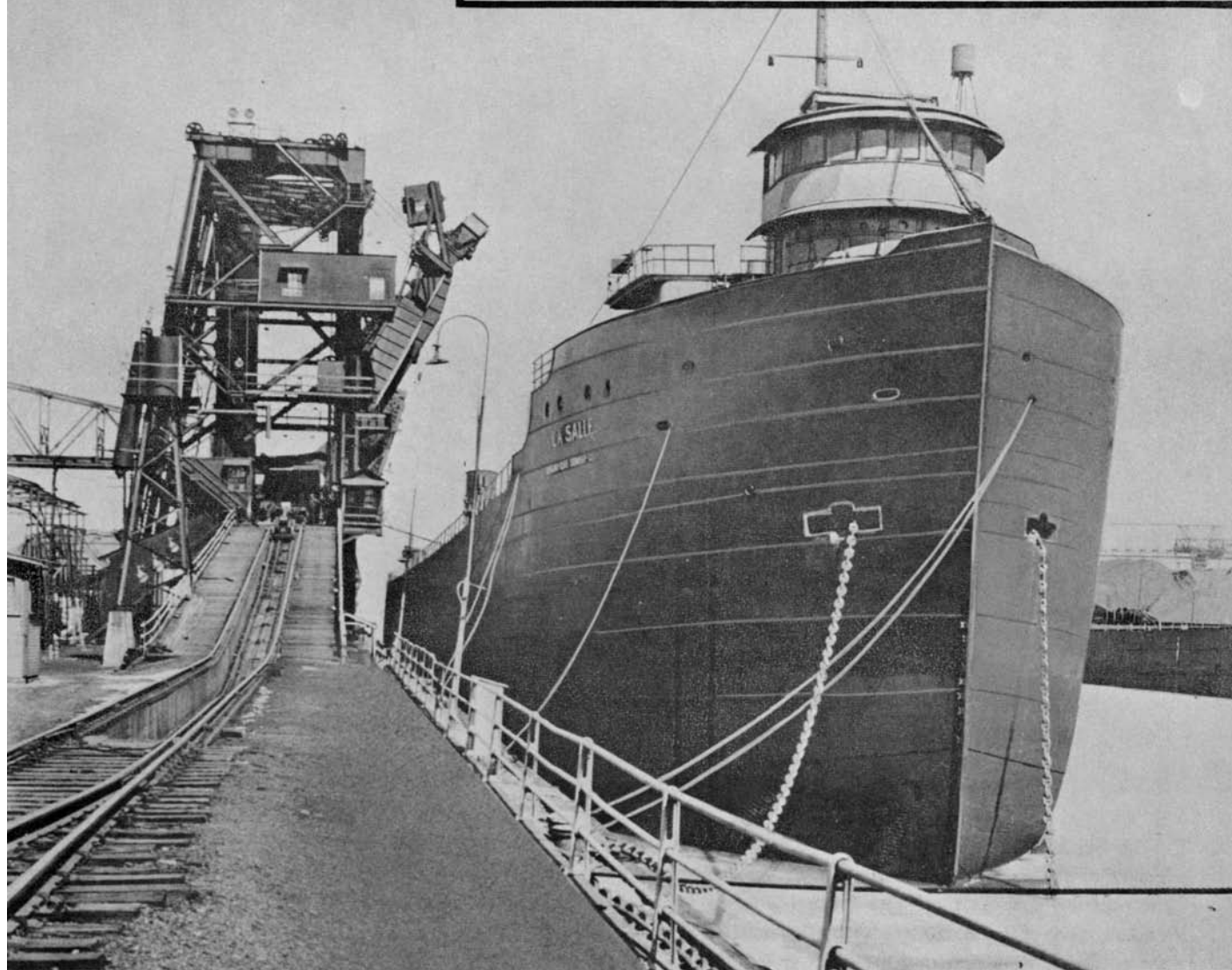

The facilities at this dock consist of a McMyler car dumper which is equipped with a sprinkling system, and gates on the telescope to assure careful handling of the coal, with an average dumping capacity of 48,000 tons per day (24 hours).

A depth of 25 feet of water at the dock is sufficient to

take care of any loading desired. It is located on the Ashtabula River about one-eighth mile from the lake protected by a government breakwall.

Yard space adjacent to the machine has a capacity of about 1,200 cars, and the supporting yards will handle the same number.

Dimensions and gross weight of cars which can be handled over this dumper are:

<i>Maximum Length Over Couplers</i>	<i>Maximum Height</i>	<i>Minimum Height</i>	<i>Maximum Width</i>	<i>Maximum Gross Weight</i>
52'6"	13'0"	6'6"	10'4"	240,000 lbs.

MAIL ADDRESS:

Agent, Pennsylvania Railroad,
753 West 48th Street
Ashtabula, Ohio
Telephone: Ashtabula 45376

SANDUSKY DOCKS, SANDUSKY, OHIO

Lake Erie Coal Dumping Facilities

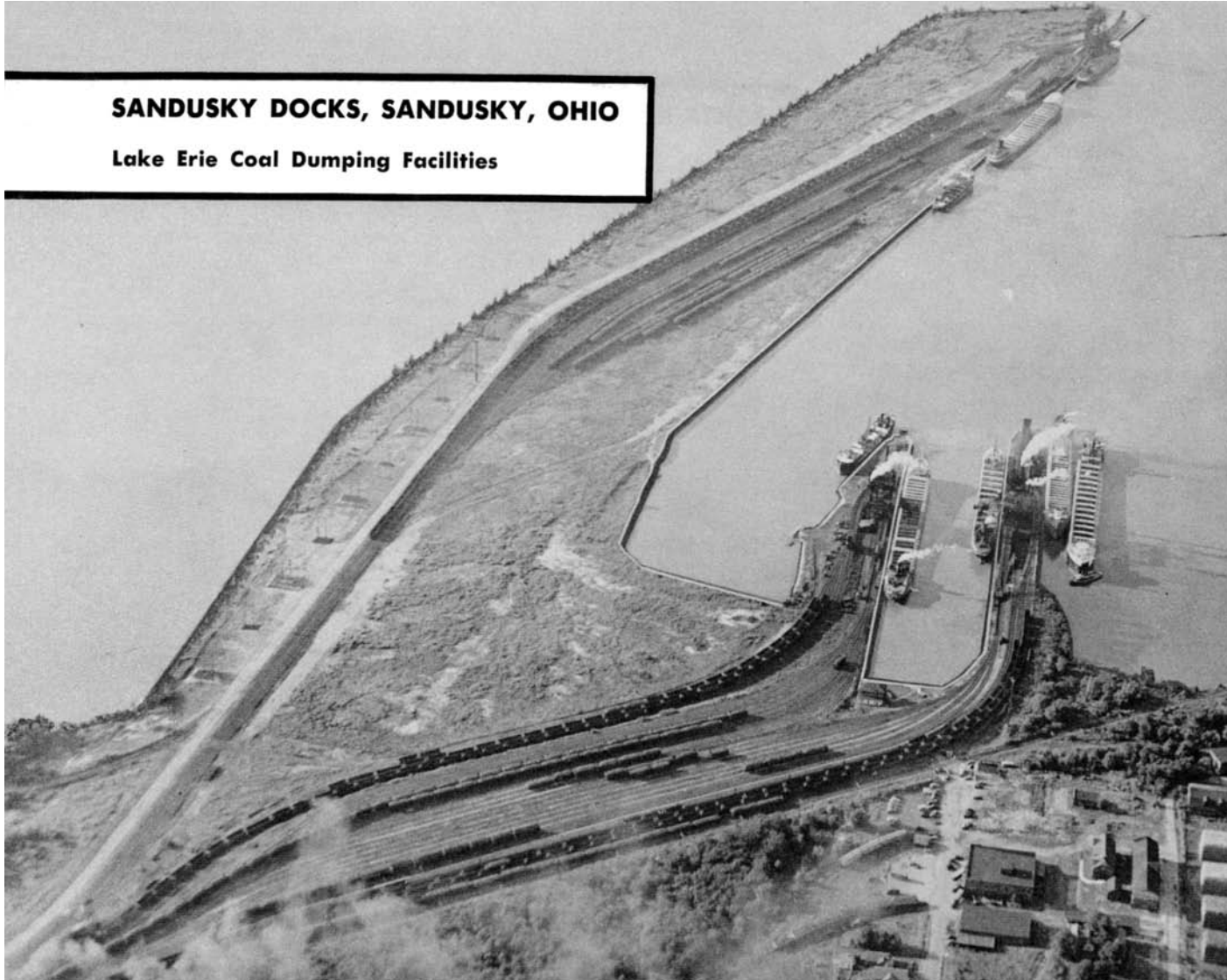

The Sandusky docks comprise the largest transshipping facility of the Pennsylvania Railroad on the Great Lakes. The equipment consists of three lift-and-turnover type unloaders, two of them modern steam operated machines, one a Heyl & Patterson and the other a Wellman-Seaver-Morgan; the third unloader is an electrically operated Heyl & Patterson machine into which have been incorporated all the latest developments in car dumper design, making it one of the most modern and efficient of its kind in the world.

Telescope gates and retarders are provided to assure careful dumping as well as automatic sprinkling and facilities for de-dusting coal.

The two steam operated machines have a combined dumping capacity of 100,000 tons per day (24 hours), and the new electric machine a capacity of an additional 86,000 tons per day (24 hours).

The steam machines are located on opposite sides of a slip approximately 1,000 feet long, 200 feet wide, and 22 feet deep. The electric machine is located on a dock 4,500 feet long served by a channel 400 feet wide and 22 feet deep. It is possible for vessels to enter and leave this dock channel without being turned.

The total yard capacity for the three machines is 10,215 cars.

Dimensions and gross weights of cars that can be handled over the car dumpers here are:

Dumper	Maximum Length Over Couplers	Maximum Height	Minimum Height	Maximum Width	Maximum Gross Weight
No. 1	64'0"	13'0"	6'6"	11'0"	330,000 lbs.
No. 2	53'0"	13'0"	6'6"	11'0"	280,000 lbs.
No. 3	64'0"	13'0"	6'6"	11'0"	333,000 lbs.

MAIL ADDRESS: Agent, Pennsylvania Railroad,
Sandusky, Ohio
Telephone: Sandusky 1558

**ALPHABETICAL LIST OF BITUMINOUS COAL MINES ON
THE PENNSYLVANIA RAILROAD
INDIANA AND ILLINOIS**

INDEX No.	MAP C	MINE	STATE	INDEX No.	MAP C	MINE	STATE
8	H-6	Airline No. 32	Ind.	1	H-5	Quality No. 2	Ind.
2	H-5	Chinook	Ind.	9	H-6	Shasta	Ind.
10	G-7	Enoco	Ind.	7	H-6	Sullivan No. 27	Ind.
4	G-5	Green Valley	Ind.	3	G-5	Tri-K-Mine	Ind.
6	B-7	Lumaghi Nos. 2 & 4	Ill.	5	G-4	Wabash	Ind.

**GEOGRAPHICAL LIST OF BITUMINOUS COAL MINES ON
THE PENNSYLVANIA RAILROAD
INDIANA AND ILLINOIS**

INDEX No.	MAP C	MINE	LOCATION OF MINE AT OR NEAR	OPERATOR	P. O. ADDRESS
PENNSYLVANIA RAILROAD					
Southwestern Region					
Center Point Branch					
1	H-5	Quality No. 2	Center Point Ind.	Quality Coal Co.	Terre Haute Ind.
2	H-5	Chinook	Staunton Ind.	Ayrshire Patoka Collieries	Indianapolis Ind.
3	G-5	Tri-K-Mine	Terre Haute Ind.	Tri-K-Mining Co.	Terre Haute Ind.
4	G-5	Green Valley	West Terre Haute Ind.	Snow Hill Coal Corp.	Terre Haute Ind.
5	G-4	Wabash	West Terre Haute Ind.	Snow Hill Coal Corp.	Terre Haute Ind.
6	B-7	Lumaghi Nos. 2 & 4	Collinsville Ill.	Lumaghi Coal Co.	St. Louis Mo.
Vincennes Branch					
Green County Coal Branch					
7	H-6	Sullivan No. 27	Linton Ind.	Maumee Collieries, Inc.	Terre Haute Ind.
8	H-6	Airline No. 32	Linton Ind.	Maumee Collieries, Inc.	Terre Haute Ind.
9	H-6	Shasta	Edwardsport Ind.	Shasta Coal Corp.	Box 278, Bicknell Ind.
10	G-7	Enoco	Bicknell Ind.	Enoco Collieries, Inc.	Indianapolis Ind.



Map C
BITUMINOUS COAL MINES
Illinois—Indiana

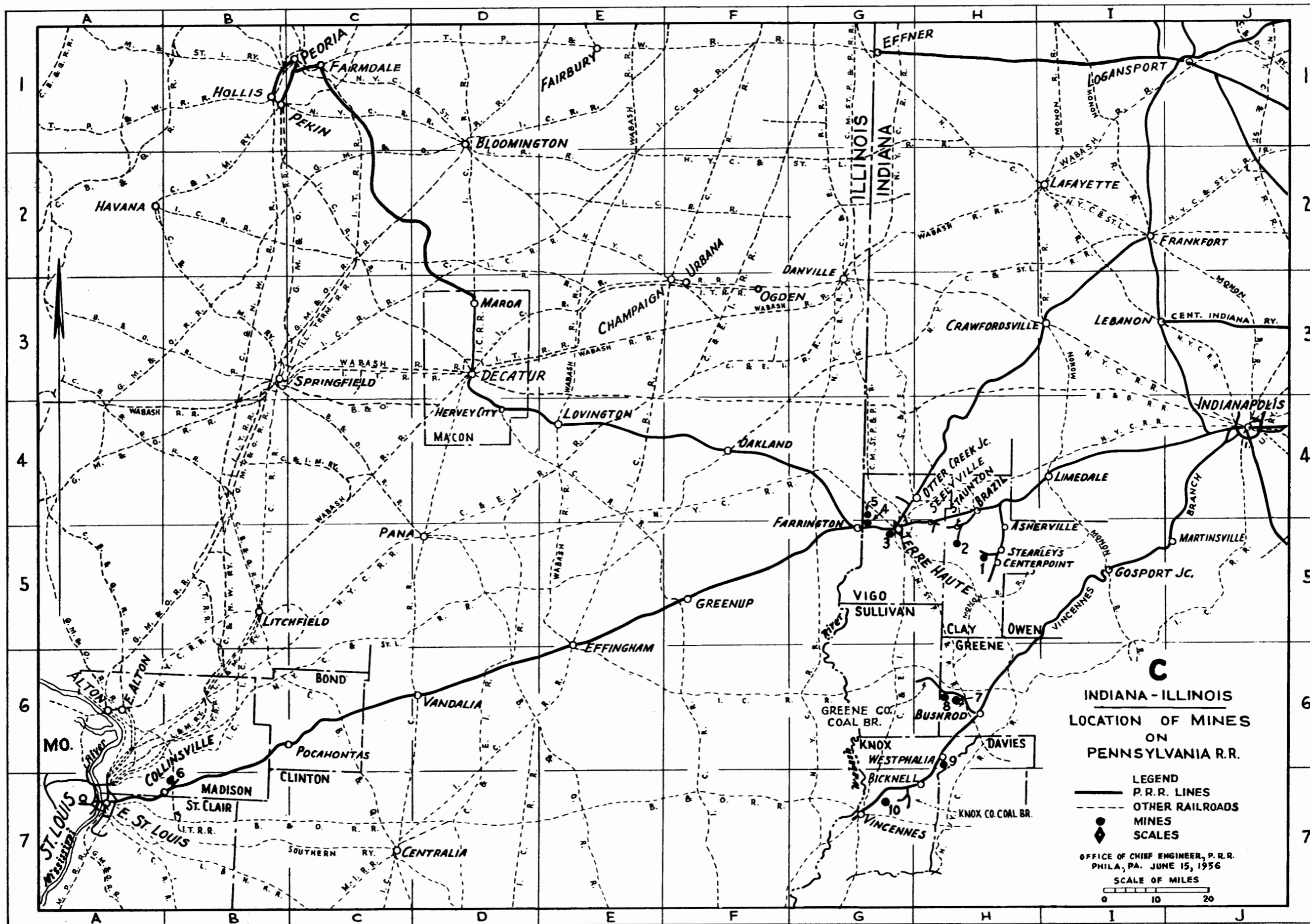

ALPHABETICAL LIST OF OPERATORS OF ANTHRACITE MINES ON THE PENNSYLVANIA RAILROAD

OPERATOR	P. O. ADDRESS	MINE	STATE	MAP LOCATION	INDEX No.
American Briquet Co.	Lewis Tower Bldg., Phila. Pa.	Ambricoal	Pa.	H-2	21
Coal Castle Fuels, Inc.	Coal Castle Pa.	Lytle Washery	Pa.	G-4	8
Continental Coal Co.	Ashland Pa.	Wisconisco Breaker	Pa.	H-2	22
D. & Z. Coal Co.	Shamokin Pa.	Weigh Scales	Pa.	F-3	15
Diamond Coal Co.	Box 125, Atlas Pa.	Atlas Colliery	Pa.	F-4	19
Floss Coal Co.	Minersville Pa.	Floss Colliery	Pa.	G-4	10
Gowen Coal Co.	Fern Glen Pa.	Gowen	Pa.	E-5	2
Hanna, M. A. (Susquehanna Collieries Division)	Nanticoke Pa.	Glen Burn Colliery	Pa.	F-3	17
Hanna, M. A. (Susquehanna Collieries Division)	Nanticoke Pa.	Glen Lyon Colliery	Pa.	D-5	1
Hoover Bros. Coal Co.	R. D. No. 2, Selinsgrove Pa.	Paxinos	Pa.	F-3	13
Hoover Coal Mining Co.	118 No. 6th St., Sunbury Pa.	Paxinos	Pa.	F-3	12
Hoover Coal Mining Co.	118 No. 6th St., Sunbury Pa.	Sobers Dam	Pa.	F-3	14
Jac Coal Co.	Minersville Pa.	Jac Colliery	Pa.	G-4	6
Jonathan Coal Mining Co.	1416 Chestnut St., Philadelphia Pa.	Shamrock	Pa.	F-3	11
Live Oak Coal Co.	Minersville Pa.	Live Oak Breaker	Pa.	G-4	9
Mineral Coal Corp.	St. Clair Pa.	Wolf Creek Colliery	Pa.	G-5	4
Morea Mining Co.	Morea Pa.	Morea Colliery	Pa.	F-5	3
Penna Coal Co.	Minersville Pa.	Penna Coal Co.	Pa.	G-4	5
Reading Anthracite Co.	Reading Terminal, Philadelphia Pa.	Oak Hill Colliery	Pa.	G-4	7
Rosini Bros.	Box 184, Shamokin Pa.	Shamokin	Pa.	F-3	18
Stanley Coal Co.	Box 192, Shamokin Pa.	Weigh Scales	Pa.	F-3	16
Upper Dauphin Coal Co.	Minersville Pa.	Upper Dauphin Coal Co.	Pa.	H-2	20

ALPHABETICAL LIST OF ANTHRACITE MINES ON THE PENNSYLVANIA RAILROAD

INDEX No.	MAP LOCATION	MINE	STATE	INDEX No.	MAP LOCATION	MINE	STATE
21	H-2	Ambricoal	Pa.	13	F-3	Paxinos	Pa.
19	F-4	Atlas Colliery	Pa.	12	F-3	Paxinos	Pa.
10	G-4	Floss Colliery	Pa.	5	G-4	Penna Coal Company	Pa.
17	F-3	Glen Burn Colliery	Pa.	18	F-3	Shamokin	Pa.
1	D-5	Glen Lyon Colliery	Pa.	11	F-3	Shamrock	Pa.
2	E-5	Gowen	Pa.	14	F-3	Sobers Dam	Pa.
6	G-4	Jac Colliery	Pa.	20	H-2	Upper Dauphin Coal Co.	Pa.
9	G-4	Live Oak Breaker	Pa.	15	F-3	Weigh Scales	Pa.
8	G-4	Lytle Washery	Pa.	16	F-3	Weigh Scales	Pa.
3	F-5	Morea Colliery	Pa.	22	H-2	Wiconisco Breaker	Pa.
7	G-4	Oak Hill Colliery	Pa.	4	G-5	Wolf Creek Colliery	Pa.

GEOGRAPHICAL LIST OF ANTHRACITE MINES ON THE PENNSYLVANIA RAILROAD

INDEX No.	MAP LOCATION	MINE	LOCATION OF MINE AT OR NEAR	OPERATOR	P. O. ADDRESS
PENNSYLVANIA RAILROAD					
Northern Region					
Susquehanna Division					
Glenlyon Branch					
1	D-5	Glen Lyon Colliery	Glenlyon Pa.	M. A. Hanna Co. (Susquehanna Collieries Division)	Nanticoke Pa.
Philadelphia Region					
Philadelphia Terminal District					
2	E-5	Gowen	Fern Glen Pa.	Gowen Coal Co.	Fern Glen Pa.
Morea Branch					
3	F-5	Morea Colliery	Morea Pa.	Morea Mining Co.	Morea Pa.
4	G-5	Wolf Creek Colliery	Darkwater Pa.	Mineral Coal Corp.	St. Clair Pa.
Minersville Branch					
5	G-4	Penna Coal Co.	Minersville Pa.	Penna Coal Co.	Minersville Pa.
6	G-4	Jac Colliery	Minersville Pa.	Jac Coal Co.	Minersville Pa.
7	G-4	Oak Hill Colliery	Minersville Pa.	Reading Anthracite Co. ...	Reading Terminal, Philadelphia Pa.
8	G-4	Lytle Washery	Lytle Pa.	Coal Castle Fuels, Inc. ...	Coal Castle Pa.
9	G-4	Live Oak Breaker	Lytle Pa.	Live Oak Coal Co.	Minersville Pa.
10	G-4	Floss Colliery	Lytle Pa.	Floss Coal Co.	Minersville Pa.
Northern Region					
Susquehanna District					
11	F-3	Shamrock	Paxinos Pa.	Jonathan Coal Mining Co.	1416 Chestnut St., Philadelphia Pa.
12	F-3	Paxinos	Paxinos Pa.	Hoover Coal Mng. Co. ...	118 No. 6th St., Sunbury Pa.
13	F-3	Paxinos	Paxinos Pa.	Hoover Bros. Coal Co. ...	R. D. No. 2, Selinsgrove Pa.
14	F-3	Sobers Dam	Paxinos Pa.	Hoover Coal Mng. Co. ...	118 No. 6th St., Sunbury Pa.
15	F-3	Weigh Scales	Weigh Scales Pa.	D. & Z. Coal Co.	Shamokin Pa.
16	F-3	Weigh Scales	Weigh Scales Pa.	Stanley Coal Co.	Box 192, Shamokin Pa.
17	F-3	Glen Burn Colliery	Shamokin Pa.	M. A. Hanna Co. (Susquehanna Collieries Division)	Nanticoke Pa.
18	F-3	Shamokin	Shamokin Pa.	Rosini Bros.	Box 184, Shamokin Pa.
Green Ridge Branch					
19	F-4	Atlas Colliery	Mt. Carmel Pa.	Diamond Coal Co.	Box 125, Atlas Pa.
Lykens Valley Branch					
20	H-2	Upper Dauphin Coal Co.	Elizabethville Pa.	Upper Dauphin Coal Co..	Minersville Pa.
21	H-2	Ambricoal	Lykens Pa.	American Briquet Co. ...	Lewis Tower Bldg., Philadelphia Pa.
22	H-2	Wiconisco Breaker	Lykens Pa.	Continental Coal Co.	Ashland Pa.

ANTHRACITE MINES

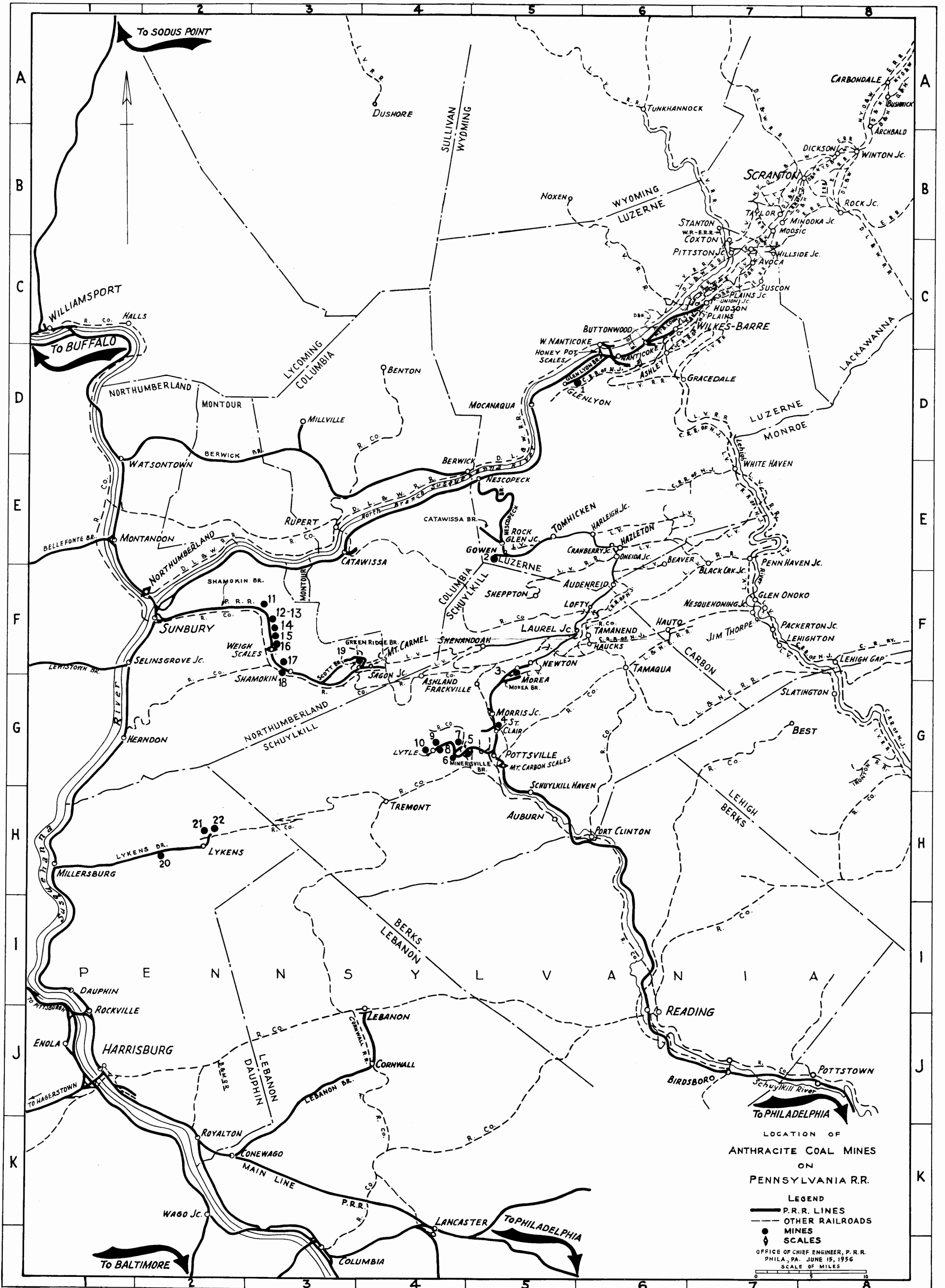

COAL CAR EQUIPMENT—THE PENNSYLVANIA RAILROAD COMPANY



THE FOLLOWING CARS ARE IN THIS CLASS

139826 to 140781	699934 to 700086
153923 " 169300	701001 " 706399
198081 " 200100	709002 " 709294
① 200104 " 219957	713936 " 714023
② 250000 " 250966	715003 " 715446
251000 " 251249	723003 " 723025
252660 " 253247	723404 " 723463
263239	723902 " 724011
263651 to 263852	724481 " 724504
265001 " 265210	724769 " 727099
675001 " 675796	727452 " 729780
685003 " 685545	748118 " 749998
695001 " 695328	891589 " 891733
697332 " 697928	892578 " 893920
698002 " 698265	896819 " 898294

- ① This group contains 289 "Class GLCA" cars.
② This group contains 29 "Class GLCA" cars.

CLASS GLA

50-TON
SELF-CLEARING
STEEL HOPPER CAR
TWO HOPPERS

CAPACITY IN CUBIC FEET

Level Full	1683
Heap	217
Total	1900

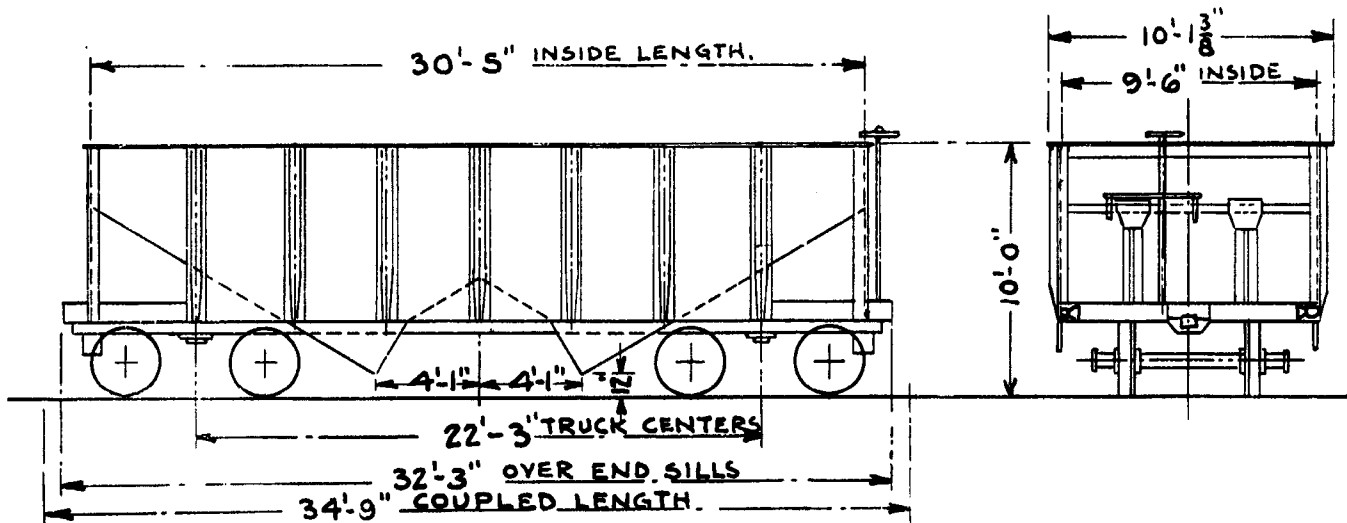

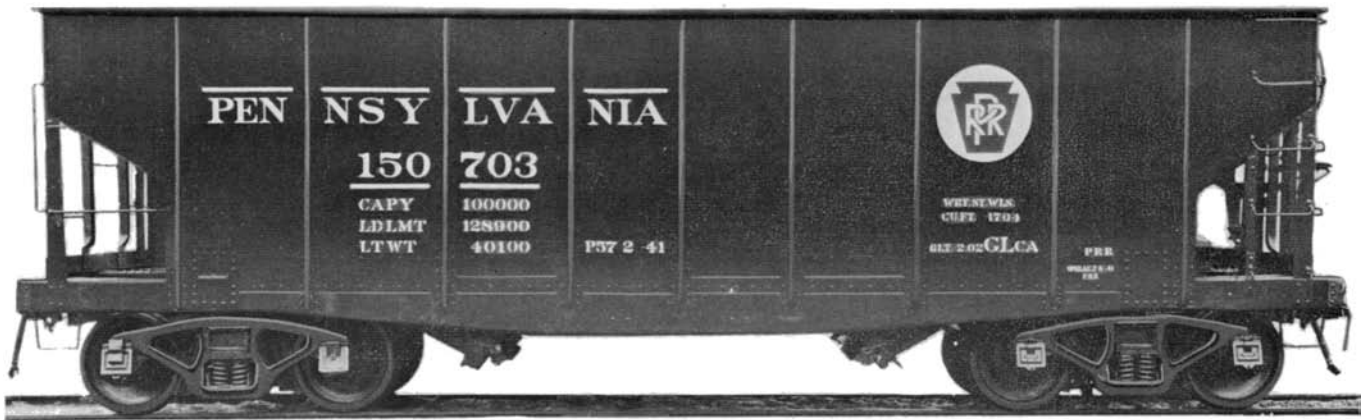

**THE FOLLOWING CARS
ARE IN THIS CLASS**

144223 to 152879	707940 to 708868
198013	714148 " 714260
① 200104 to 219957	714559 " 714972
② 250000 " 250966	716238 " 716366
263006 " 263238	721894 " 722274
263240 " 263608	736030 " 740697
682640 " 683999	892087 " 892382
693683 " 694599	894716 " 895339
697323 and 697328	898525 " 898784

- ① This group contains 676 "Class GLA" cars.
- ② This group contains 397 "Class GLA" cars.

CLASS GLCA

50-TON
SELF-CLEARING
STEEL HOPPER CAR
TWO HOPPERS

CAPACITY IN CUBIC FEET

Level Full	1704
Heap	225
Total	1929

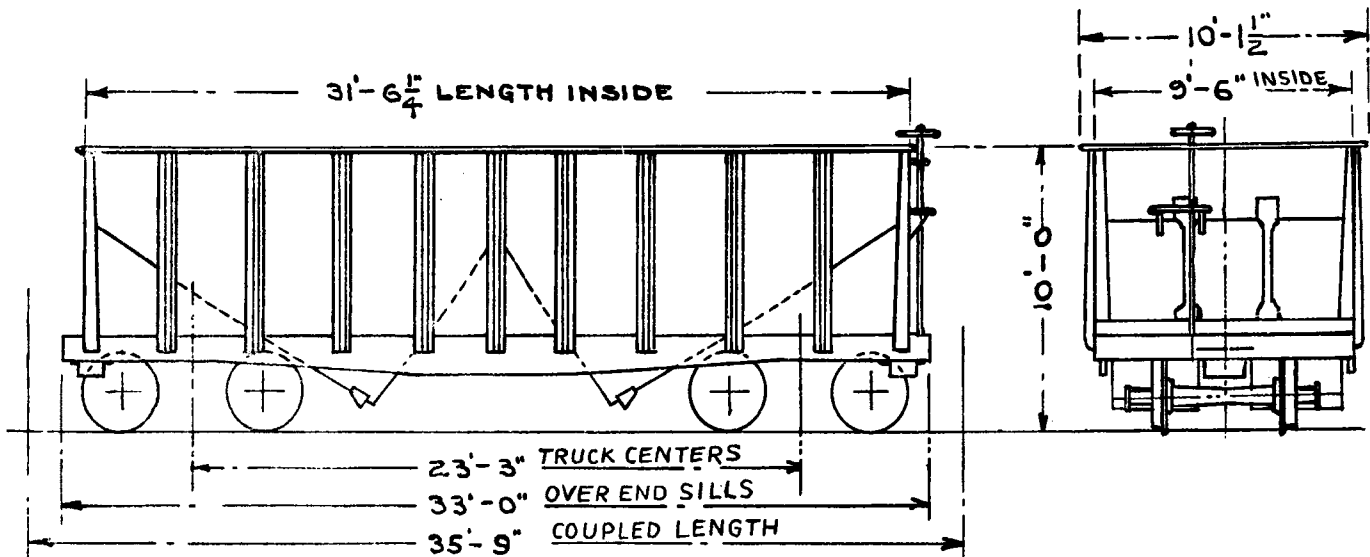

Commercial reproduction prohibited

Downloaded from <http://PRR.Railfan.net/documents>

Scanned by Rob Schoenberg, ©2010

COAL CAR EQUIPMENT—THE PENNSYLVANIA RAILROAD COMPANY



**THE FOLLOWING CARS
ARE IN THIS CLASS**

220300 to 220841
222501 " 222670

CAPACITY IN CUBIC FEET

Level Full	1859
Heap	256
<hr/>	
Total	2115

CLASS H-31

55-TON
SELF-CLEARING
STEEL HOPPER CAR
TWO HOPPERS

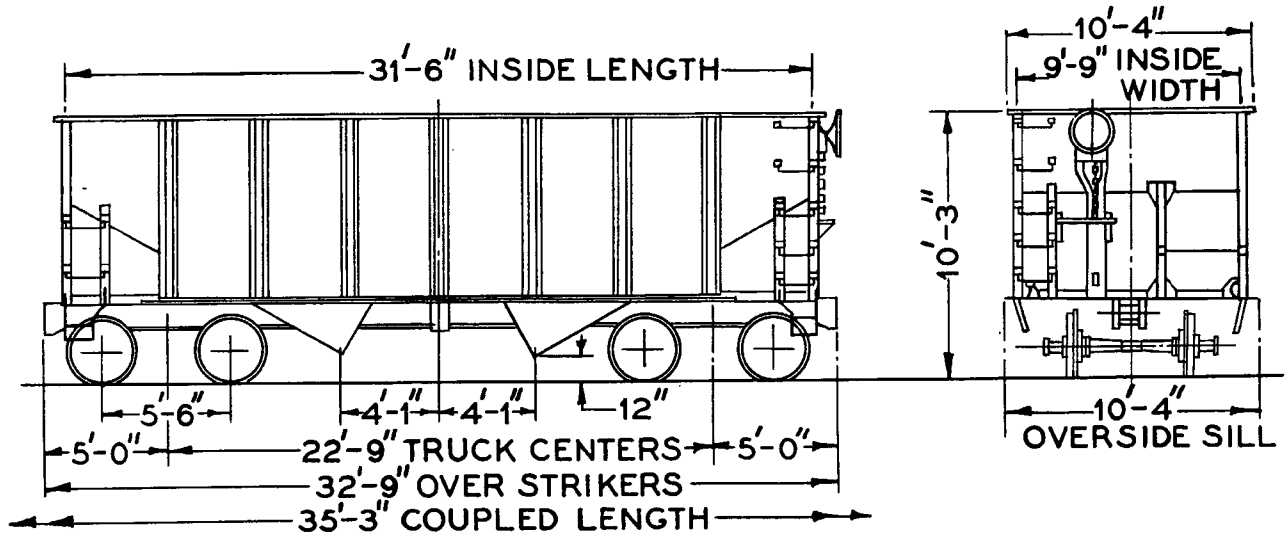

Commercial reproduction prohibited
Downloaded from <http://PRR.Railfan.net/documents>
Scanned by Rob Schoenberg, ©2010



THE FOLLOWING CARS
ARE IN THIS CLASS

135500	to	139822	717118	to	717979
173625	"	180000	718969	"	720274
182299	"	197740	720452	"	720461
256481	"	257000	723027	"	723081
261461	"	262000	723124	"	723146
262931	"	263000	727101	"	727443
266922	"	267000	730896	"	730913
676001	"	677045	741001	"	746000
677426	"	677484	746464	"	748098
685607	"	686352	900219	"	903877
686468	and	686469	904807	"	905160
695330	to	695984	909011	"	909720
700600	"	700881	910405	"	910503
706401	"	706909	910880	"	912493
707017	"	707046	913383	"	913472
709975	"	710067	917627	"	918343
714300	"	714462	923243	"	924106

CLASS H-21-A

70-TON
SELF-CLEARING
STEEL HOPPER CAR
FOUR HOPPERS

CAPACITY IN CUBIC FEET

Level Full	2547
Heap	286
Total	2833

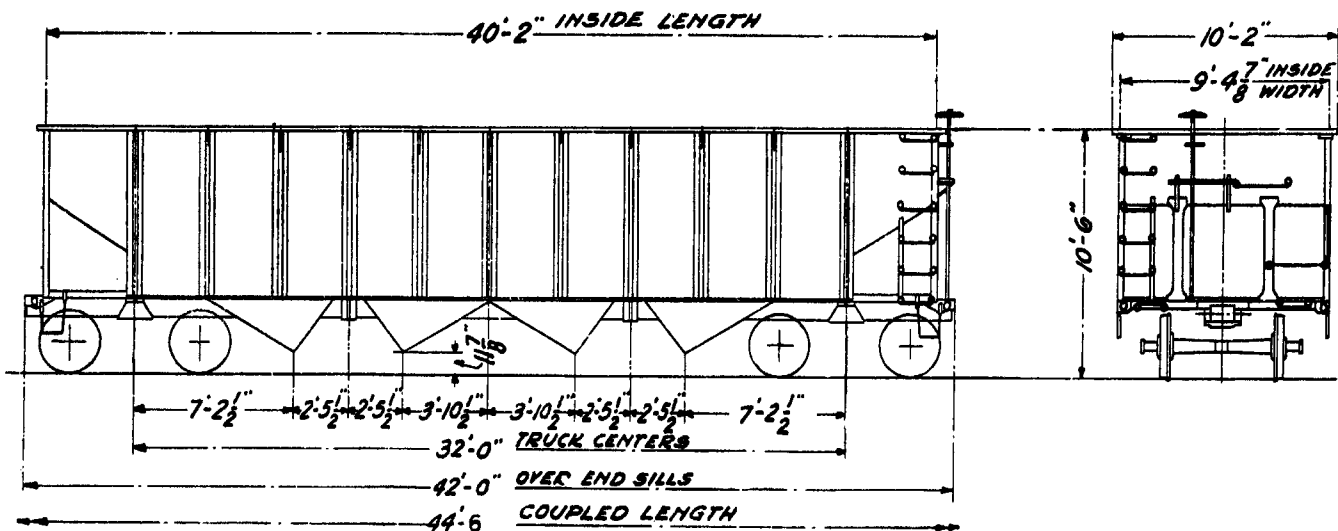

Commercial reproduction prohibited

Downloaded from <http://PRR.Railfan.net/documents>

Scanned by Rob Schoenberg, ©2010

COAL CAR EQUIPMENT—THE PENNSYLVANIA RAILROAD COMPANY



**THE FOLLOWING CARS
ARE IN THIS CLASS**

- 169635 to 172921
- 677046 " 677423
- 686354 " 686467
- 706910 " 707016
- 710069 " 710073
- 720276 " 720448
- 723082 " 723123
- 729803 " 730893
- 740702 " 740726
- 909741 " 909795

CLASS H-25

- 70-TON
- SELF-CLEARING
- STEEL HOPPER CAR
- FOUR HOPPERS

CAPACITY IN CUBIC FEET

Level Full	2500
Heap	281
Total	2781

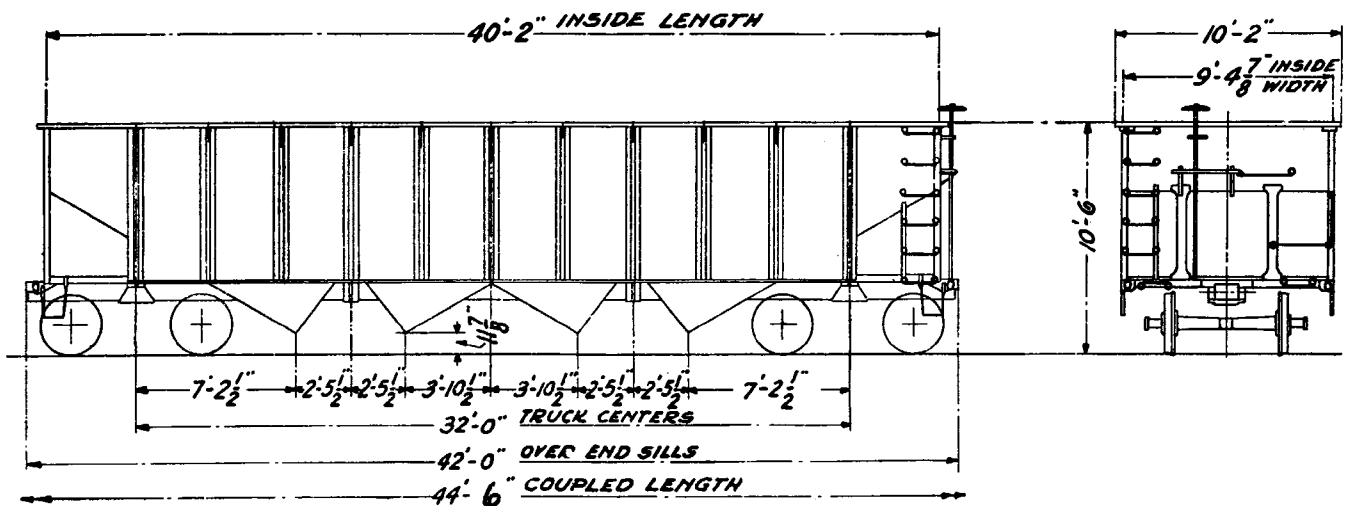

COAL CAR EQUIPMENT—THE PENNSYLVANIA RAILROAD COMPANY

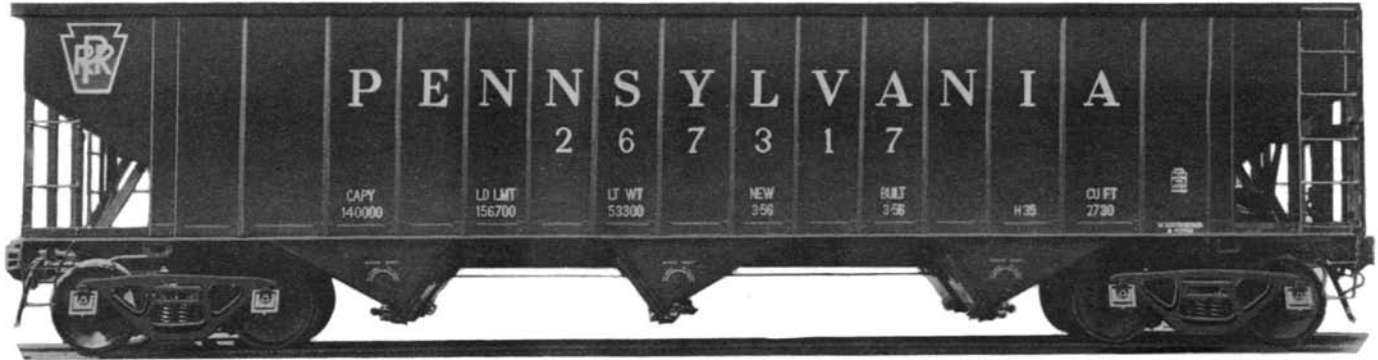

THE FOLLOWING CARS
ARE IN THIS CLASS

267001 to 269000

CAPACITY IN CUBIC FEET

Level Full	2730
Heap	341
Total	3071

CLASS H-35

70-TON
SELF-CLEARING
STEEL HOPPER CAR
THREE DOUBLE-
BANKED HOPPERS

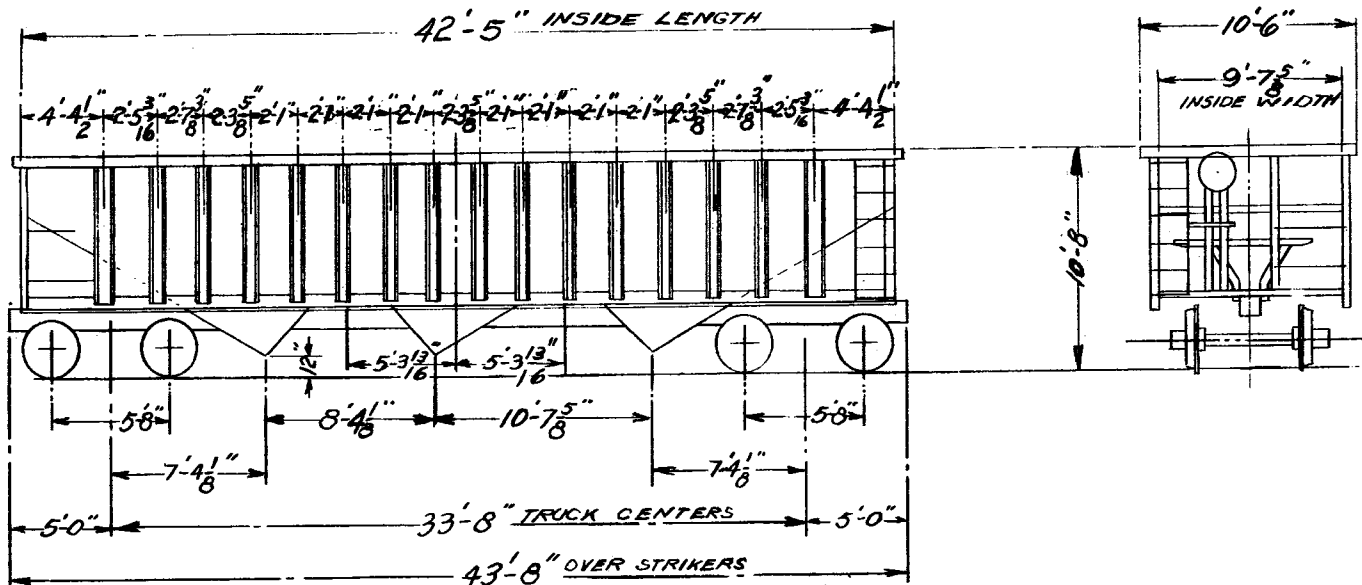

Commercial reproduction prohibited

Downloaded from <http://PRR.Railfan.net/documents>

Scanned by Rob Schoenberg, ©2010

COAL CAR EQUIPMENT—THE PENNSYLVANIA RAILROAD COMPANY

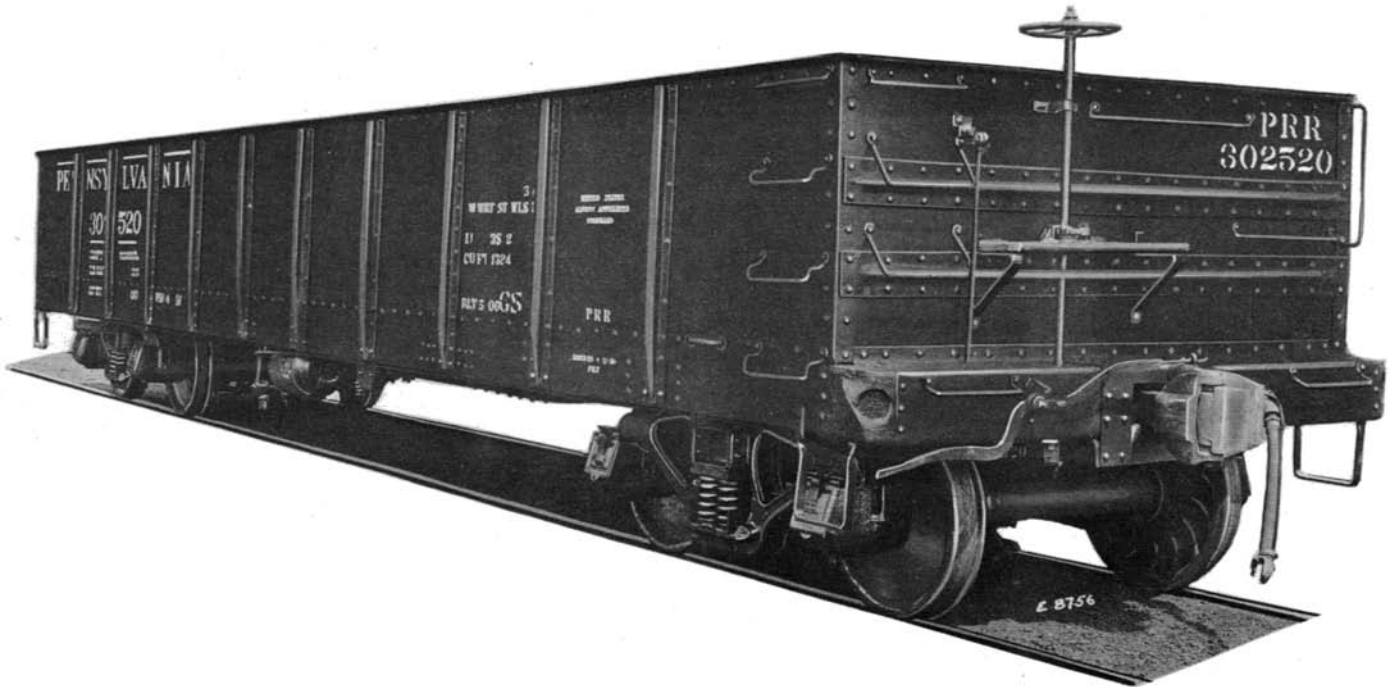

**THE FOLLOWING CARS
ARE IN THIS CLASS**

287808 to 305732	800248 to 800944
321323 " 325000	855203 " 856331
350724 " 351472	859833 " 862870
360407	876755
370068	877002
380164 to 381923	880705
750002 " 750527	881222
775097	881516
793394 and 793414	882260
795002 to 795305	882483

CLASS GS

50-TON STEEL
GONDOLA CAR
SOLID BOTTOM
TIGHT ENDS

CAPACITY IN CUBIC FEET

Level Full	1331
Heap	265
Total	1596

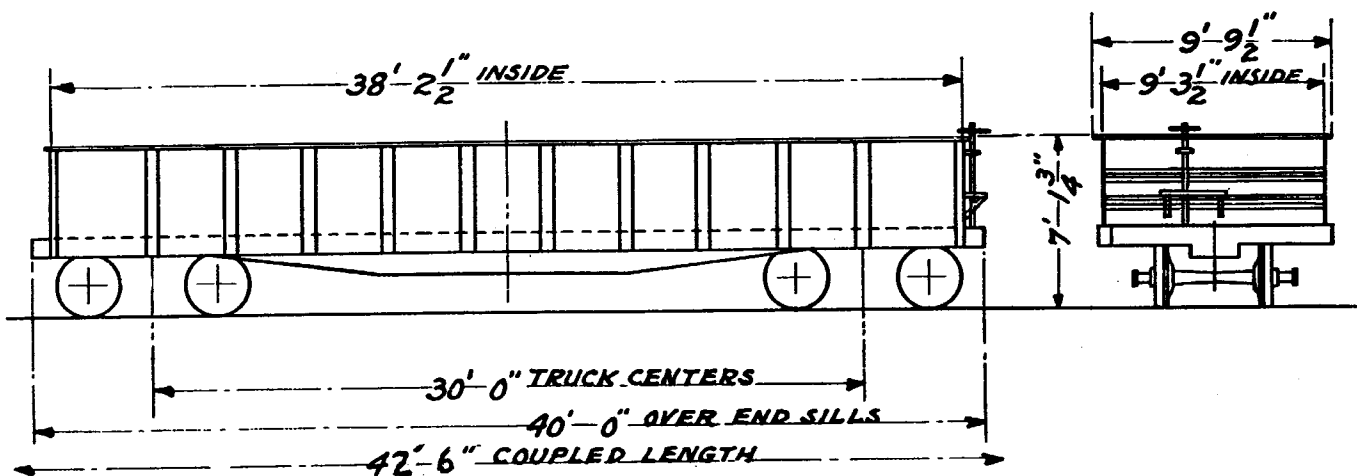

COAL CAR EQUIPMENT—THE PENNSYLVANIA RAILROAD COMPANY

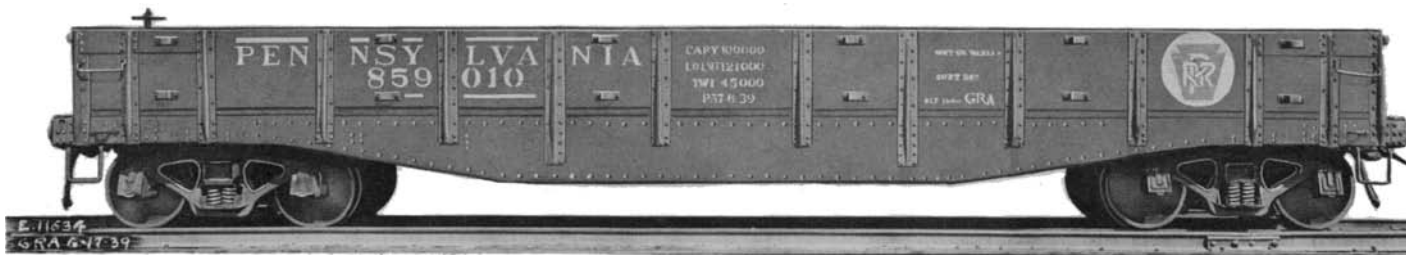

**THE FOLLOWING CARS
ARE IN THIS CLASS**

- 334088 to 338001
- 355084 " 357000
- 367708 " 368279
- 370500 " 370561
- 383757 " 384999
- 390068 " 390150
- 769783 " 771096
- 792494 " 793373
- 799470 " 799529
- 806956 " 807582
- 822279 " 823136
- 839121 " 839225
- 852505 " 854235
- 857910 " 859811
- 863001 " 863652
- 880124

CLASS GRA

50-TON WOODEN
GONDOLA CAR
SOLID BOTTOM
DROP ENDS

CAPACITY IN CUBIC FEET

Level Full	897
Heap	266
Total	1163

