

Galveston Subdivision

Temple, TX (M.P. 218.1) to Galveston, TX (M.P. 2.2)

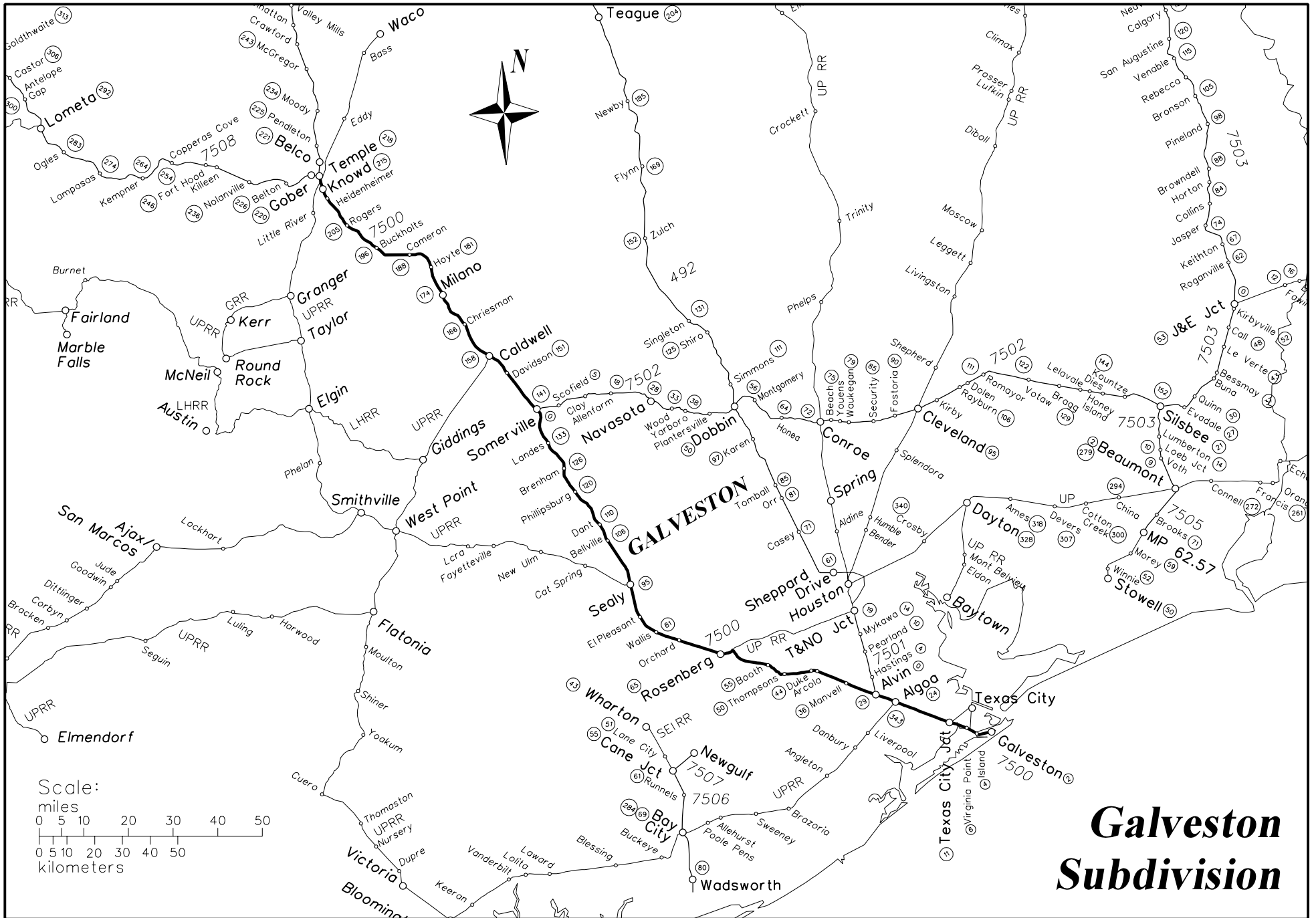

← Station West

Line Segment Number

Station East →

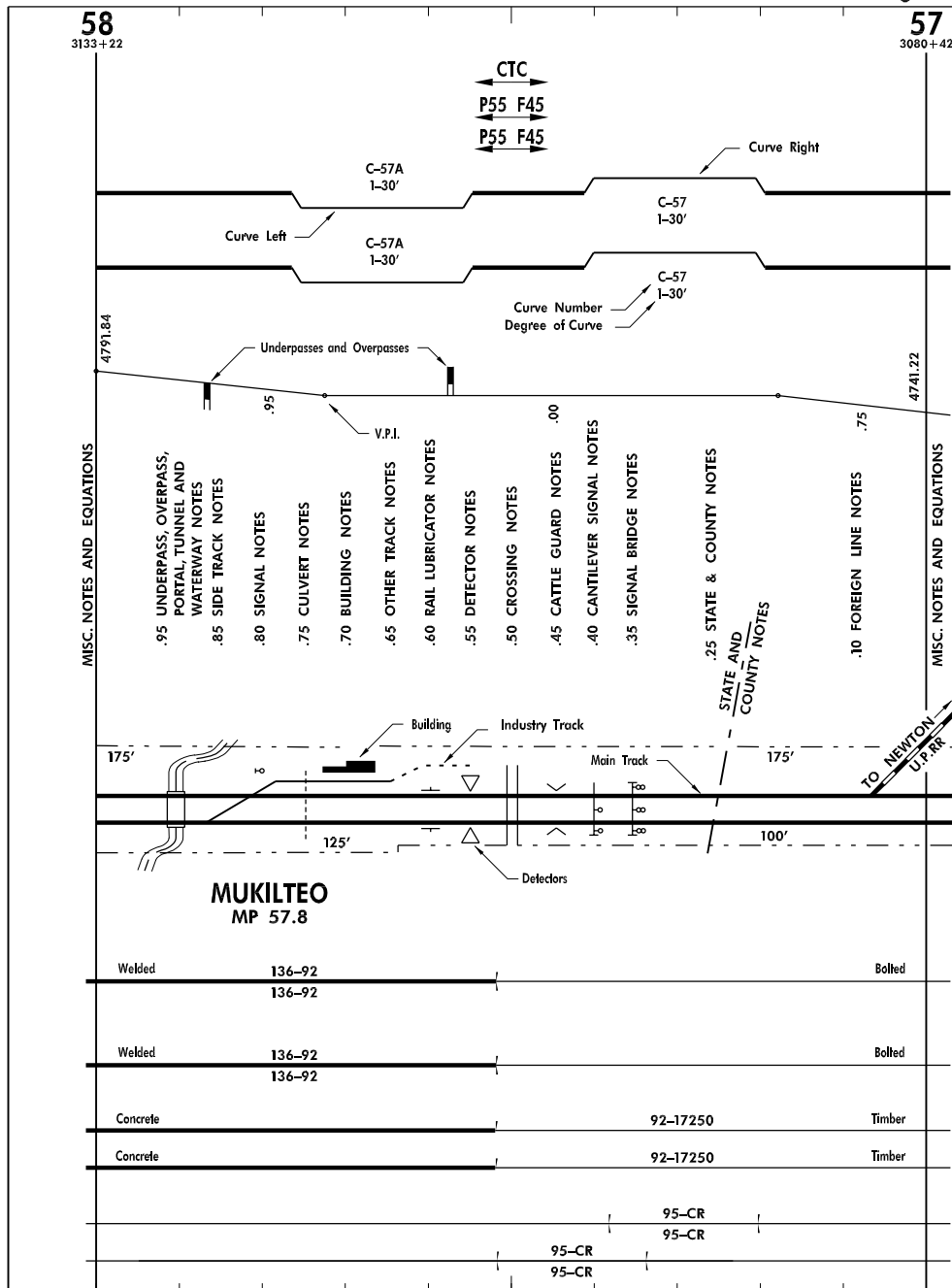

- Milepost Number
Survey Station
Method of Operation
- CONTROL**
- 1st Main Speeds
2nd Main Speeds
- CURVES**
- Curve Right
1st Main Tangent
Curve Left
- Curve Right
2nd Main Tangent
Curve Left
- GRADE**
- Elevation
Grade Line
Grade
- Plan View Milepost
and Feature Description
- Foreign Line
- PLAN**
- Right-of-Way Line
Right-of-Way Dimension
- 1st Main
2nd Main
Right-of-Way Dimension
Right-of-Way Line
- Station Name
Station Milepost
- RAILS**
- Weight - Year
1st Main - Rail Type
Weight - Year
- Weight - Year
2nd Main - Rail Type
Weight - Year
- TIES**
- 1st Main - Year-Number Installed
2nd Main - Year-Number Installed
- TRACK STABILIZATION**
- Shoulder Ballast Cleaning Year
1st Main
Undercut Year
Shoulder Ballast Cleaning Year
2nd Main
Undercut Year

TRACK CHART FEATURE LEGEND

NOTES

BRIDGES
THE MILEPOST LOCATIONS OF BRIDGES SHOWN ON THE GRADE ARE AT THE CENTER OF THE BRIDGES.

GRADE
RAILROAD ELEVATIONS ARE SHOWN PERIODICALLY AND USGS ELEVATIONS ARE SHOWN WHERE KNOWN. WHERE THE GRADE CHANGES ARE TOO NUMEROUS OVER SHORT DISTANCES TO CLEARLY SHOW, GRADE IS SHOWN AS AN AVERAGE.

MILEPOST
SIGNIFICANTLY LONG OR SHORT MILES ARE NOTED WITH THEIR RESPECTIVE EQUATIONS.

TRACK
MAIN LINES ARE SHOWN WITH A BOLD LINE. SIDING CAPACITIES ARE TRAIN CAPACITIES IN FEET.

RAIL
WELDED RAIL IS SHOWN WITH A BOLD LINE. BOLTED RAIL IS SHOWN WITH A THIN LINE.

TIES
CONCRETE TIES ARE SHOWN WITH A BOLD LINE. TIMBER TIES ARE SHOWN WITH A THIN LINE.

SCALE 1" = 2640'

HORIZONTAL SCALE FOR ALIGNMENT AND TRACKS.

SYMBOLS

- Rail Lubricator
 - All types of signals, except bridge signals
 - Crossing warning device, flashing signals with automatic gates
 - Slide detector
 - AE1 Automatic equipment identification reader
 - Shifted load indicator
 - Hot bearing detector
 - Dragging equipment detector, arrow or arrows denote direction protected
 - Yard limit sign
 - Switching limit sign
- *2-69.3-A P.U.C. number, as shown on public road crossings
026007F D.O.T. number, as shown on public and private crossings

TRACK CHART ABBREVIATION LEGEND

BRIDGES & CULVERTS

A	ARCH
AB	ABUTMENT
AP	APPROACH
AR	ARCH
ARM TL	ARMCO TUNNEL LINER
B	BOX
BASC	BASCULE
BD	BALLAST DECK
BDPT	BALLAST DECK PILE TRESTLE - WOOD
BR	BRIDGE
BRK	BRICK
BX	BOX
C	CONCRETE
CA	CONCRETE ARCH
CB	CONCRETE BOX
CBG	CONCRETE BOX GIRDER
CCTS	COMBINATION CONCRETE & TIMBER SLAB
CG	CONCRETE "I" GIRDER
CIP	CAST IRON PIPE
CMA	CURRUGATED METAL ARCH
CMP	CORRUGATED METAL PIPE
CTG	CONCRETE "T" GIRDER
CP	CONCRETE PIPE
CUL	CULVERT
DBL	DOUBLE
DG	DECK GIRDER
DPG	DECK PLATE GIRDER
DPLG	DECK PLATE LATTICE GIRDER
DPCT	DECK PIN CONNECTED TRUSS
DR SP	DRAW SPAN
DRT	DECK RIVETED TRUSS
DS	SWING SPAN
DT	DECK TRUSS
EXT	EXTENSION
FT	FRAME TRESTLE - WOOD
FTG	FOOTING
GCIP	GALVANIZED CORRUGATED IRON PIPE
GIP	GALVANIZED IRON PIPE
IB	"I" BEAM OR GIRDER BEAM SPAN
I BM	"I" BEAM
LG	LONG
LS	LIFT SPAN
MPP	MULTI-PLATE PIPE
MSY	MASONRY
O	OVAL
OCF	OVAL CONCRETE PIPE
OD	OPEN DECK
OMP	OVAL METAL PIPE
ORCP	OVAL REINFORCED CONCRETE PIPE
PC	PRE-STRESSED CONCRETE
PCMP	PERFORATED CORRUGATED CONCRETE PIPE
PED	PEDESTAL
PRT	PONT RIVETED TRUSS
PT	PILE TRESTLE - WOOD
RCA	REINFORCED CONCRETE ARCH
RCB	REINFORCED CONCRETE BOX

RCP	REINFORCED CONCRETE PIPE
RCT	REINFORCED CONCRETE TRESTLE
RD WD	REDWOOD
RSB	REINFORCED STONE BOX
RTB	RAIL TRACK BOX
RTCB	RAIL TOP CONCRETE BOX
RTSB	RAIL TOP STONE BOX
SA	STEEL ARCH
SBG	STEEL BOX GIRDER
SP	STEEL PIPE
SPP	STEEL PLATE PIPE
SSC	STEEL STRINGERS & CAPS
SSP	STRUCTURAL STEEL PIPE
STA	STONE ARCH
STB	STONE BOX
STO	STONE
T	TILE
T BX	TIMBER BOX
TL	TUNNEL LINER
TH G	THRU GIRDER
TH T	THRU TRUSS
TLG	THRU LATTICE GIRDER
TP	TILE PIPE
TPCT	THRU PIN CONNECTED TRUSS
TPG	THRU PLATE GIRDER
TR	TREATED
TR	T-RAIL
TRIP	TRIPLE
TRT	THRU RIVETED TRUSS
VIT P	VITRIFIED PIPE
VP	VITRIFIED PIPE
VTP	VITRIFIED TILE PIPE
WB	WOOD BOX
WD	WOOD
WF	WIDE FLANGE BEAM SPAN
WP	WOOD PIPE
WR IP	WROUGHT IRON PIPE

TRACK & SIGNAL

ABS	AUTOMATIC BLOCK SIGNAL SYSTEM
APB	AUTOMATIC PERMISSIVE BLOCK
ATS	AUTOMATIC TRAIN STOP
AUTO GATE	AUTOMATIC GATE
B	BOLTED RAIL
BLK	BLOCK
BP	BUMPING POST
BR SIG	BRIDGE SIGNAL
C	CURVE /CONTROLLED SWITCH /CONCRETE
C SIG	CONTROL SIGNAL
CANT SIG	CANTILEVER SIGNAL
CAP	CAPACITY
CTC	CENTRALIZED TRAFFIC CONTROL
DC SW	DUAL CONTROL SWITCH
DE DET	DRAGGING EQUIPMENT DETECTOR
EQLAT	EQUILATERAL SWITCH
F	FREIGHT (SPEED)

FL LUB	FLANGE LUBRICATOR
FLSH SIG	FLASHING SIGNAL
HB DET	HOT BOX DETECTOR
HB REFL BD	HOT BOX REFLECTOR BOARD
HW DET	HIGH WATER DETECTOR
I	TOTAL CURVE ANGLE
I SIG	INTERLOCKING SIGNAL
I SW	INTERLOCKING SWITCH
INTLK	INTERLOCKING
L	LEFT
LS	LINE SEGMENT
M	MANUAL SWITCH
MM, M	MIDDLE MAIN
MP	MILEPOST
NB	NORTHBOUND
NM, N	NORTH MAIN
OCS	OCCUPANCY CONTROL SYSTEM
OH	OVERHEAD
P	PASSENGER (SPEED) / PREMIUM RAIL POWER SWITCH / POWER
PT SW	POINT OF SWITCH
R	RIGHT
RES LIM	RESTRICTED LIMITS
RG	RAIL GRINDING
RL	RAIL LUBRICATOR
SIGS	SIGNALS
SH	SECOND HAND RAIL
SBC	SHOULDER BALLAST CLEANING
SM, S	SOUTH MAIN
S SW	SPRING SWITCH
TO	TURN-OUT
TRK	TRACK
TWC	TRACK WARRANT CONTROL
UC	UNDERCUT
W	WELDED

FACILITIES

B	BOOTH TELEPHONE
C	OFFICE OF COMMUNICATION
CDR CV	CINDER CONVEYOR
COA CH	COAL CHUTE
EXP BLDG	EXPRESS BUILDING
F	FUEL
I TOWER	INTERLOCKING TOWER
LAV	LAVATORY
O COL	OIL COLUMN
OT	OIL TANK
R	RADIO COMMUNICATION
STK YRD	STOCK YARD
T	TURNTABLE
TT	TREATMENT PLANT
W	WATER
WCOL	WATER COLUMN
WT	WATER TANK
Y	WYE

MISCELLANEOUS

AVE	AVENUE
BCH	BRANCH
BLVD	BOULEVARD
CO	COUNTY
CONN	CONNECTION
COMP	COMPUTED
CONST	CONSTRUCTED
CR	CREEK
DBL	DOUBLE
DIV	DIVISION
DOT#	DEPT. OF TRANSPORTATION CROSSING NUMBER
E	EAST
EL	ELEVATION
EW	EASTWARD
F LT P	FLOOD LIGHT POLE
F LT T	FLOOD LIGHT TOWER
FRT	FREIGHT
GR	AT GRADE
HO	HOUSE
HWY	HIGHWAY
IND	INDUSTRY
JCT	JUNCTION
LT	LEFT
MAINT	MAINTENANCE
MAX	MAXIMUM
MTCE	MAINTENANCE
NO	NORTH
OH	OVERHEAD
OP	OVERPASS
PED	PEDESTRIAN
PO	POWER
PSGR	PASSENGER
PUB	PUBLIC
PVT, PR	PRIVATE
RD	ROAD
RD XING	ROAD CROSSING
RESERV	RESERVOIR
RIV	RIVER
RR	RAILROAD
RS	RESUME SPEED
RT	RIGHT
RW	RIGHT-OF-WAY
RY	RAILWAY
SB	SOUTHBOUND
SEC	SECTION
SO	SOUTH
ST	STREET
STA	STATION
TPL	TRIPLE
UP	UNDERPASS
W	WEST
WW	WESTWARD
YD	YARD
YL	YARD LIMITS
XBUCKS	CROSSBUCKS
XING	CROSSING

← Galveston, Port Industrial Line Segment 7500 Temple, TX →

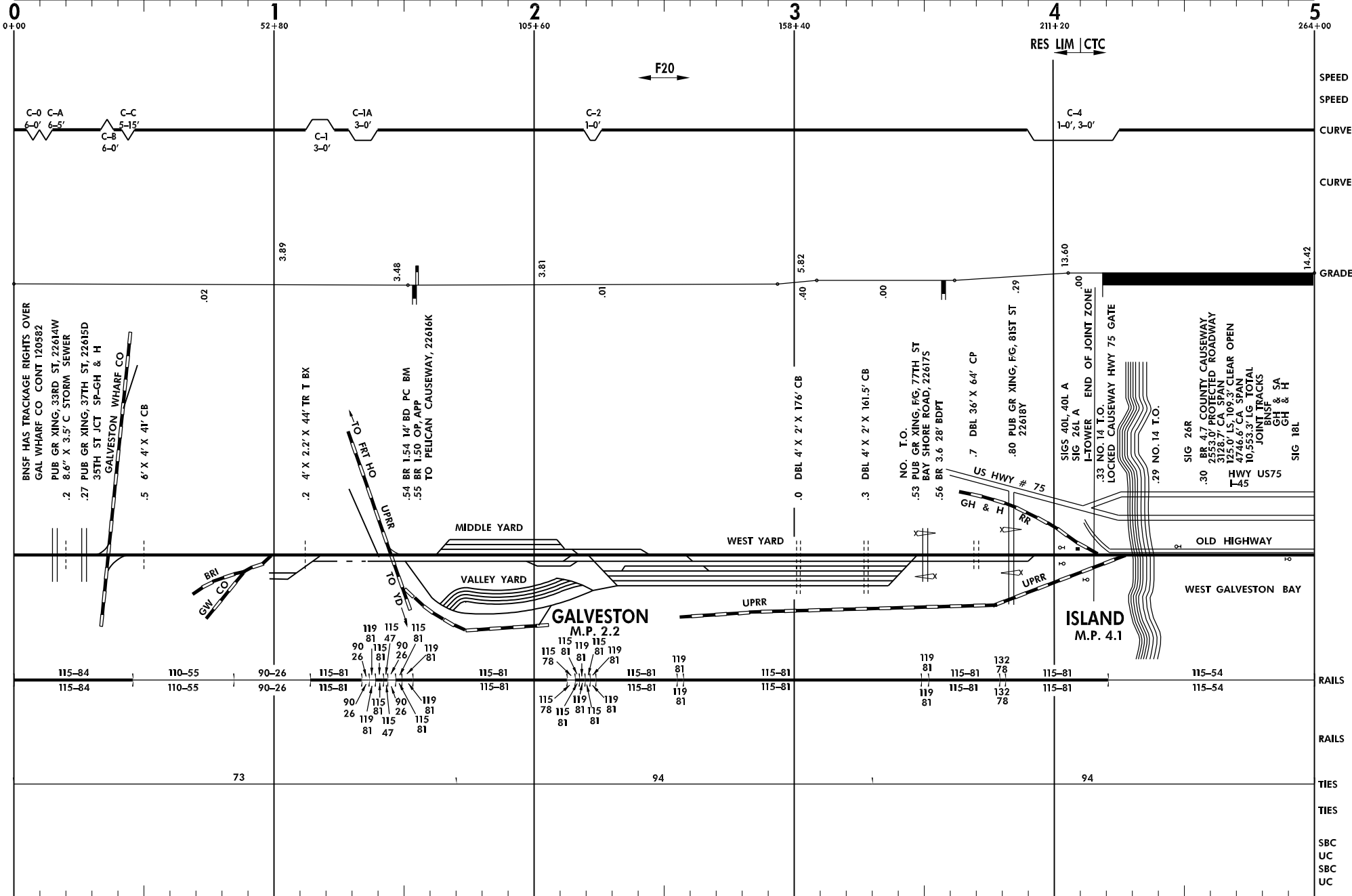

← Temple, TX

Line Segment 7500

Galveston, TX →

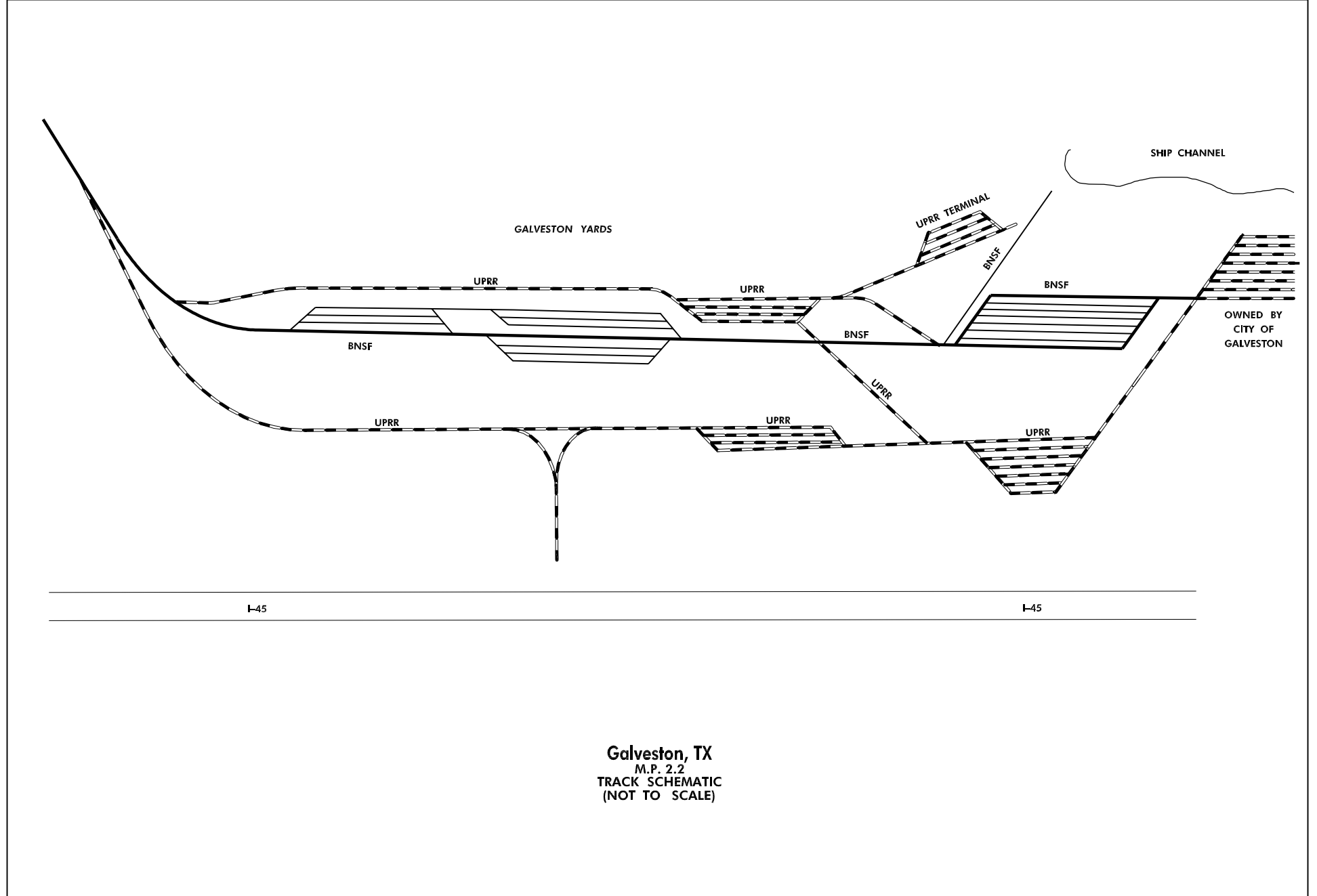

Galveston, TX
 M.P. 2.2
 TRACK SCHEMATIC
 (NOT TO SCALE)

← Galveston, TX Line Segment 7500 Temple, TX →

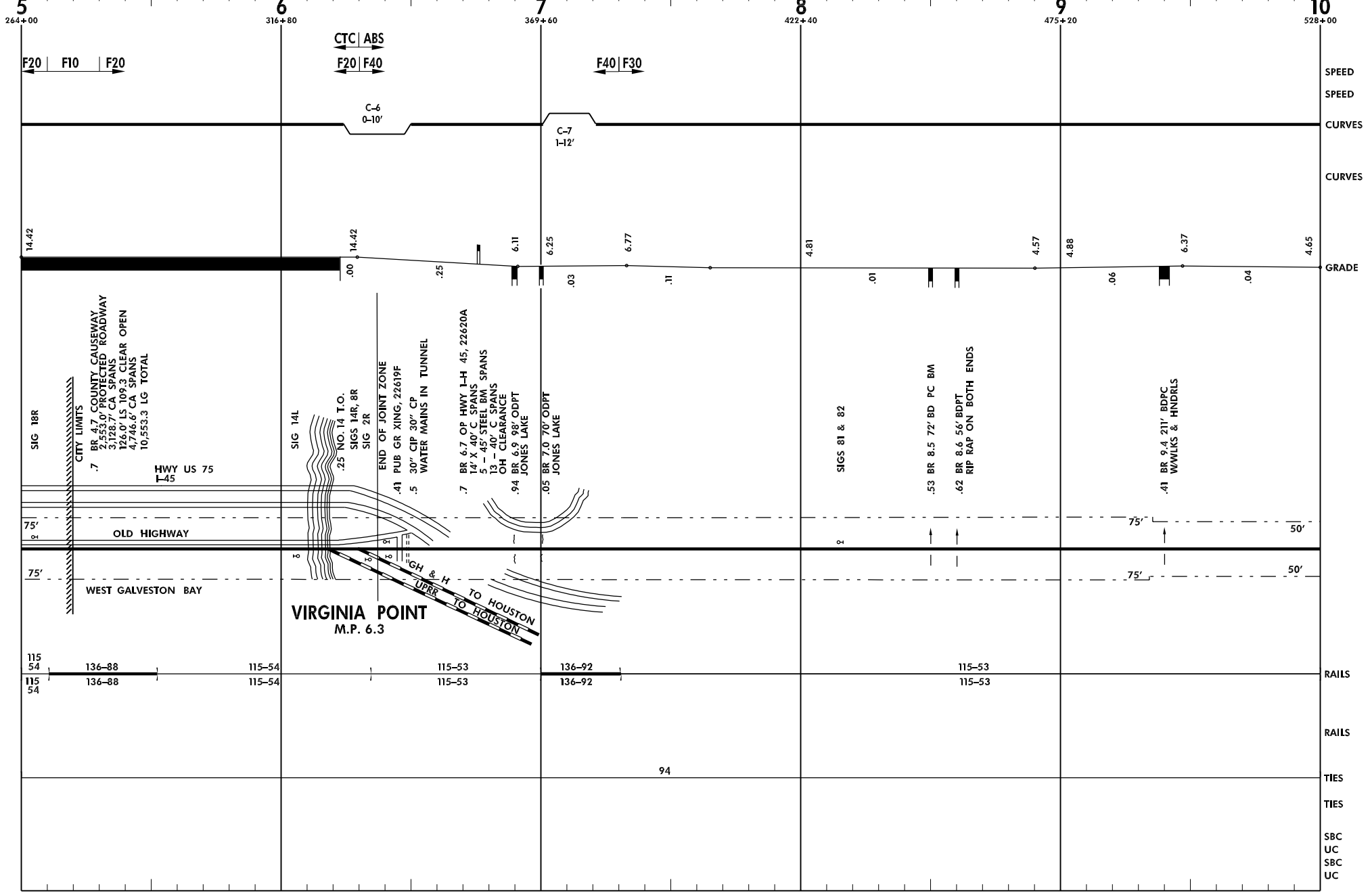

← Galveston, TX

Line Segment 7500

Temple, TX →

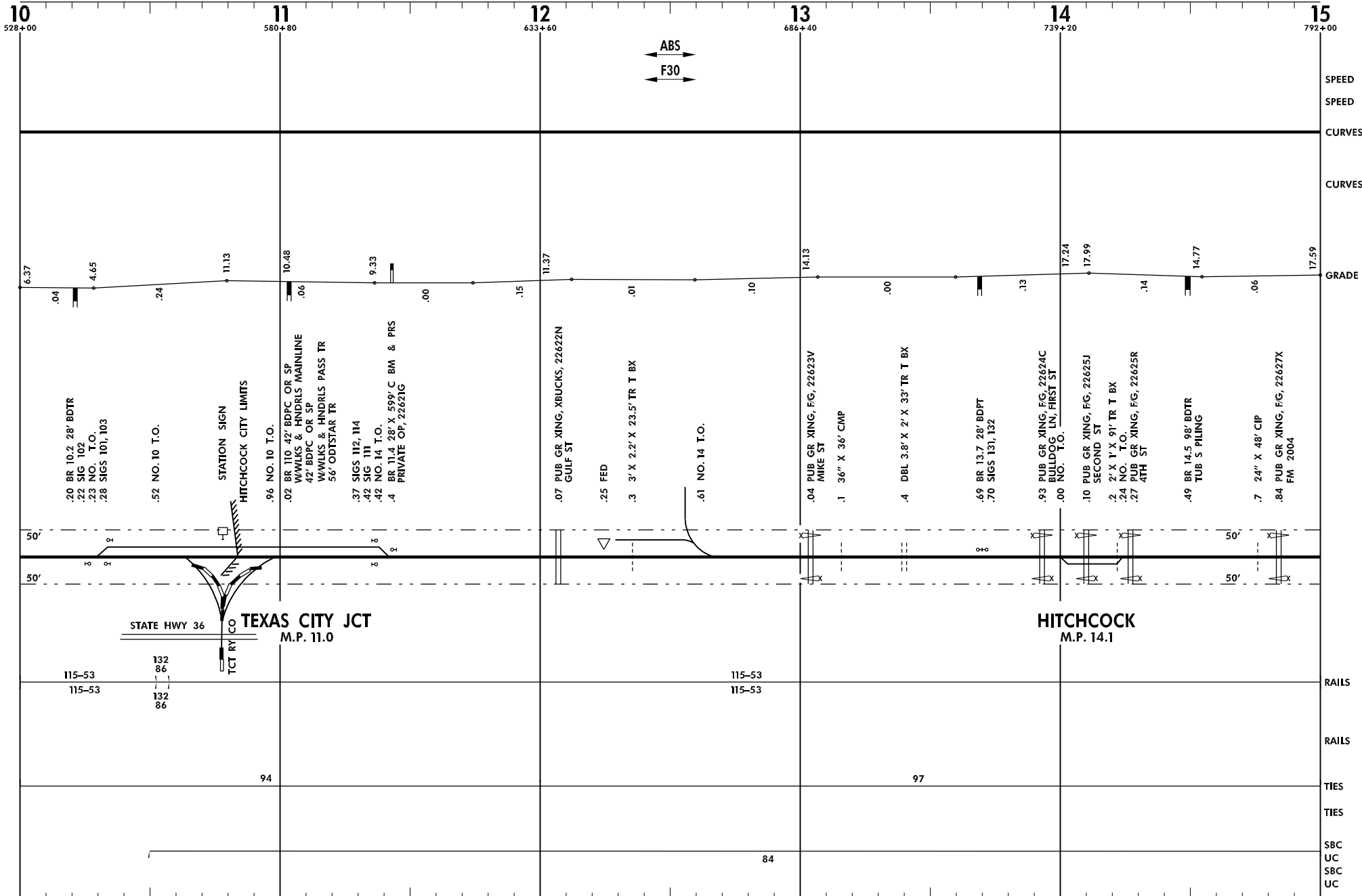

← Galveston, TX

Line Segment 7500

Temple, TX →

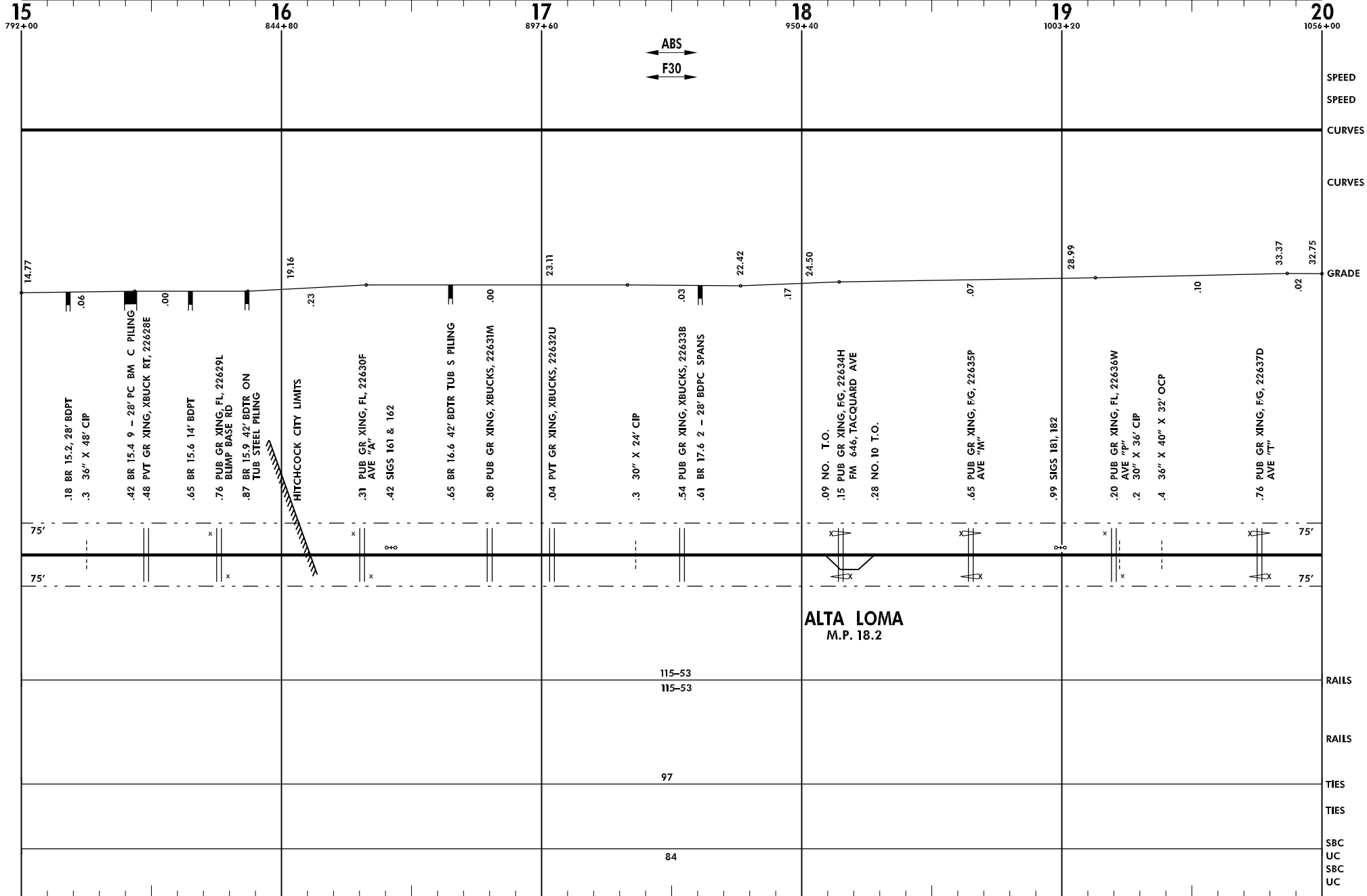

← Galveston, TX

Line Segment 7500

Temple, TX →

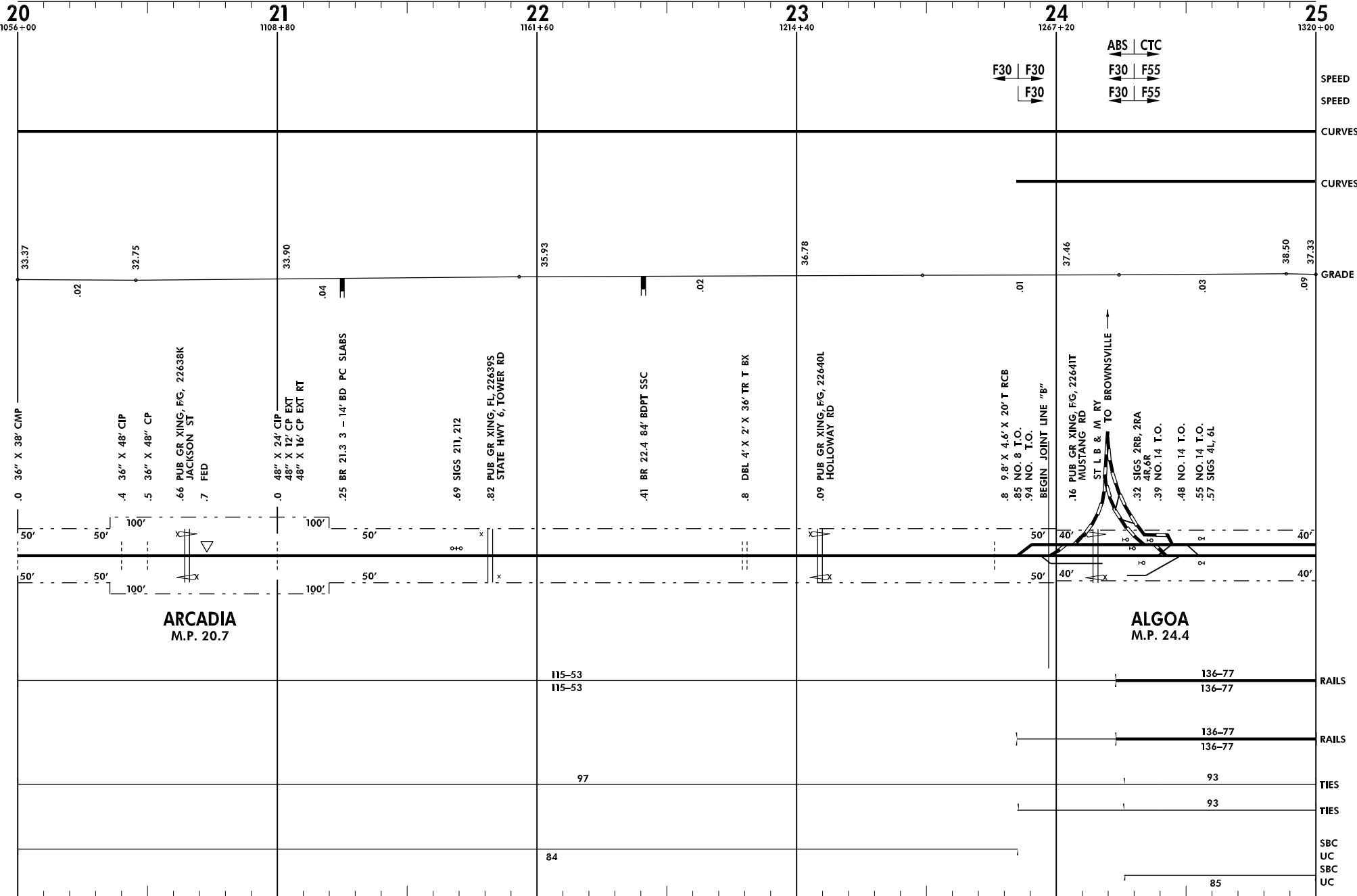

ARCADIA
M.P. 20.7

ALGOA
M.P. 24.4

115-53
115-53

136-77
136-77

97

93

84

85

← Galveston, TX

Line Segment 7500

Temple, TX →

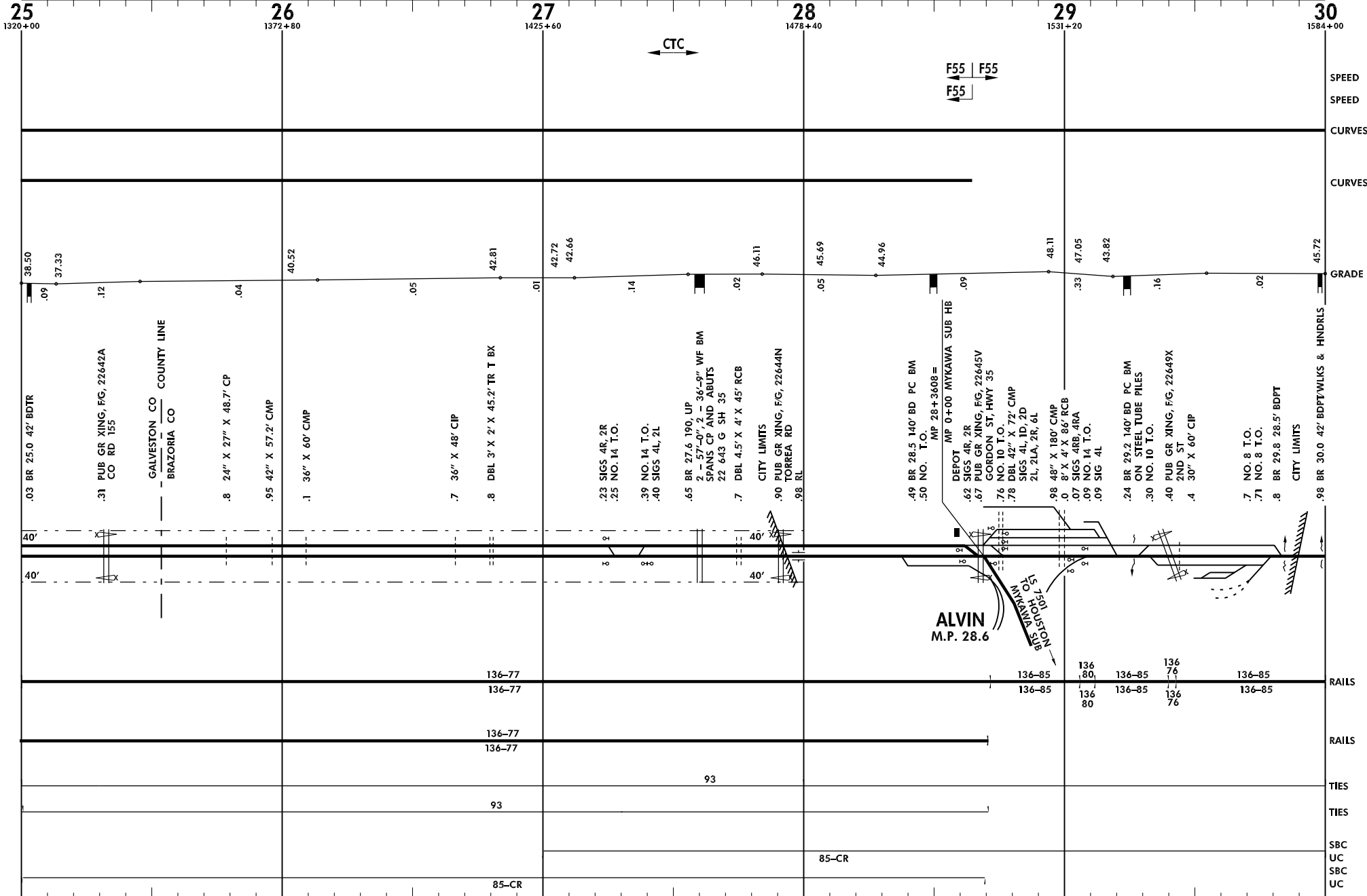

Burlington Northern and Santa Fe Railway Company

GAL006.DGN

Revised: 11/20/1998

Galveston Subdivision

← Temple, TX

Line Segment 7500

Galveston, TX →

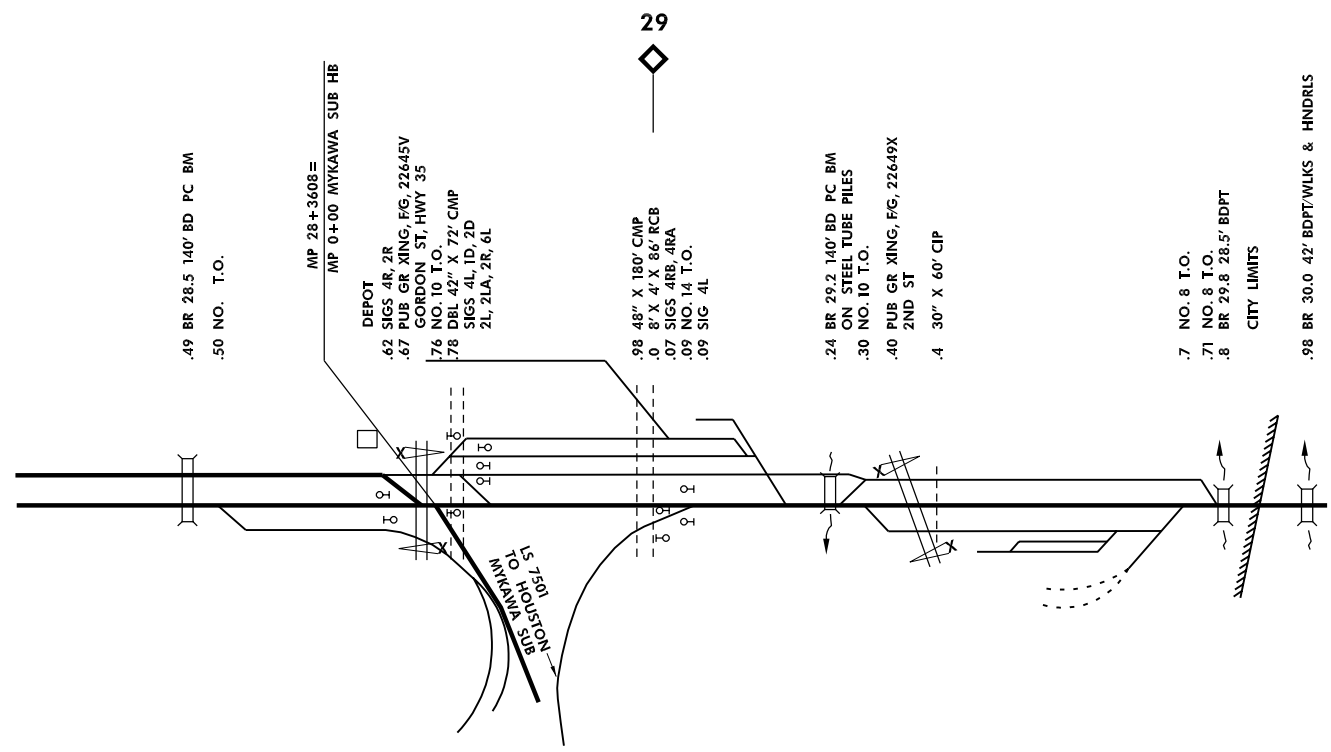

ALVIN, TX
 M.P. 28.6
 TRACK SCHEMATIC
 (NOT TO SCALE)

← Galveston, TX

Line Segment 7500

Temple, TX →

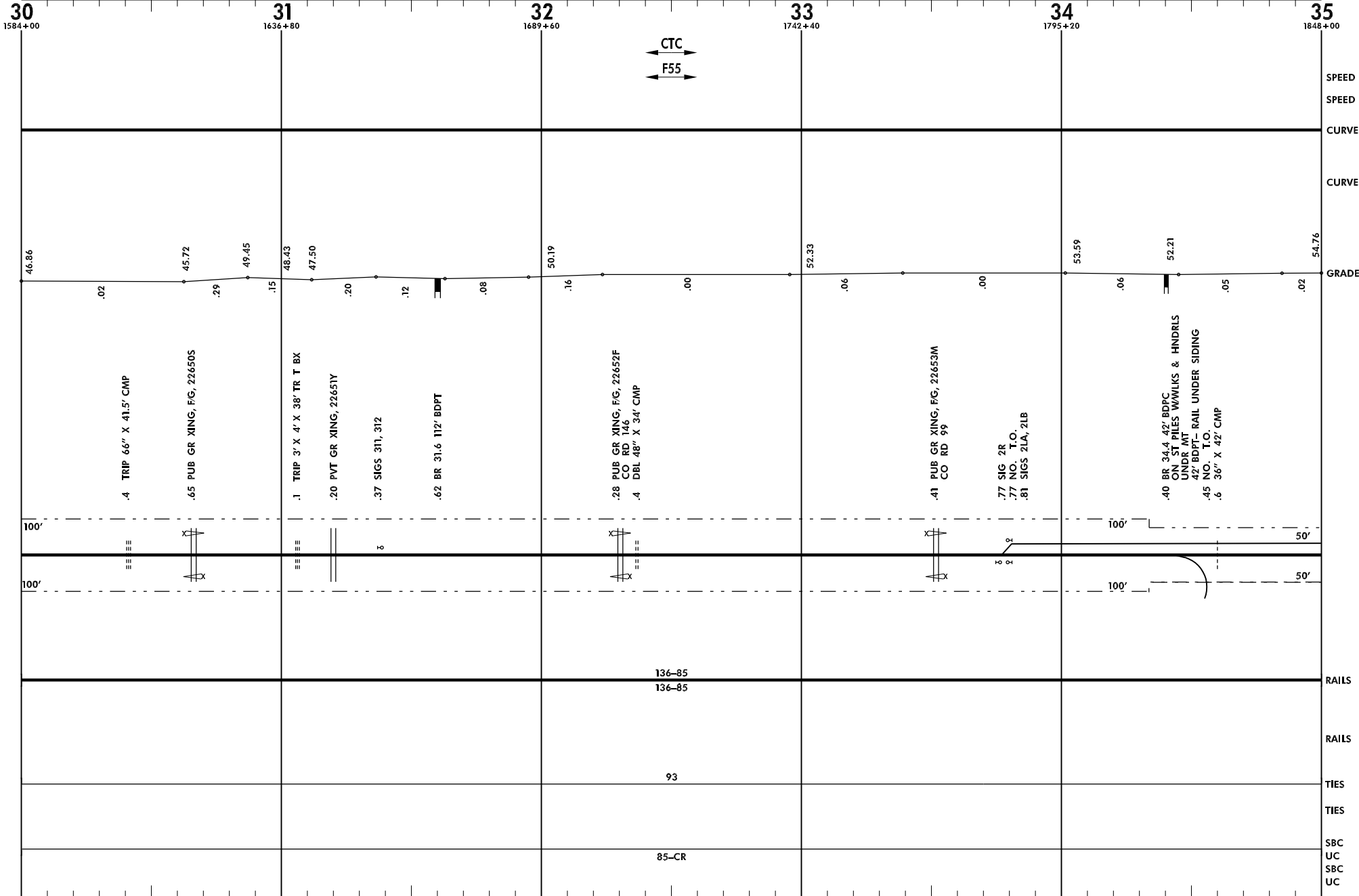

← Galveston, TX

Line Segment 7500

Temple, TX →

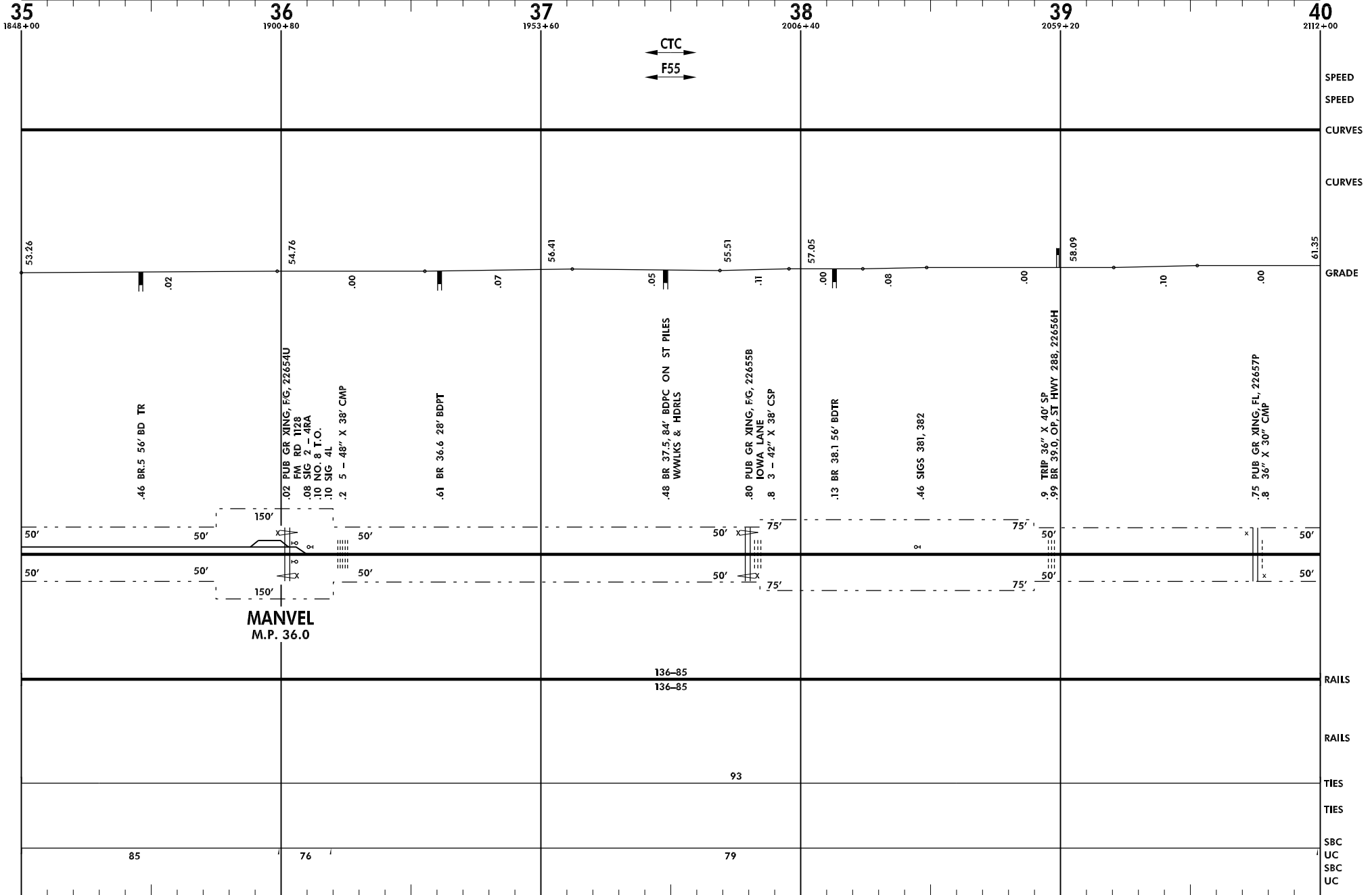

← Galveston, TX

Line Segment 7500

Temple, TX →

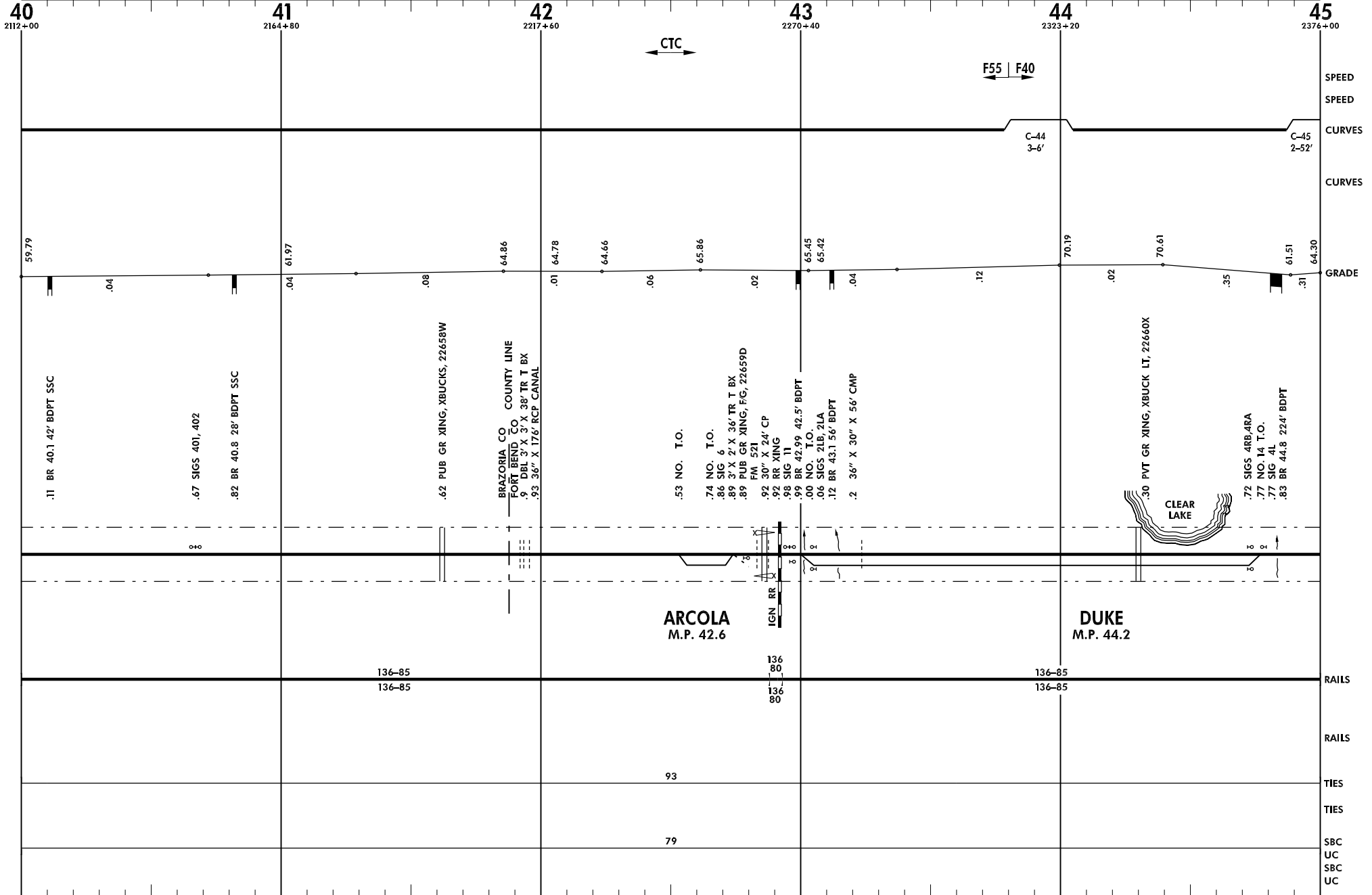

← Galveston, TX

Line Segment 7500

Temple, TX →

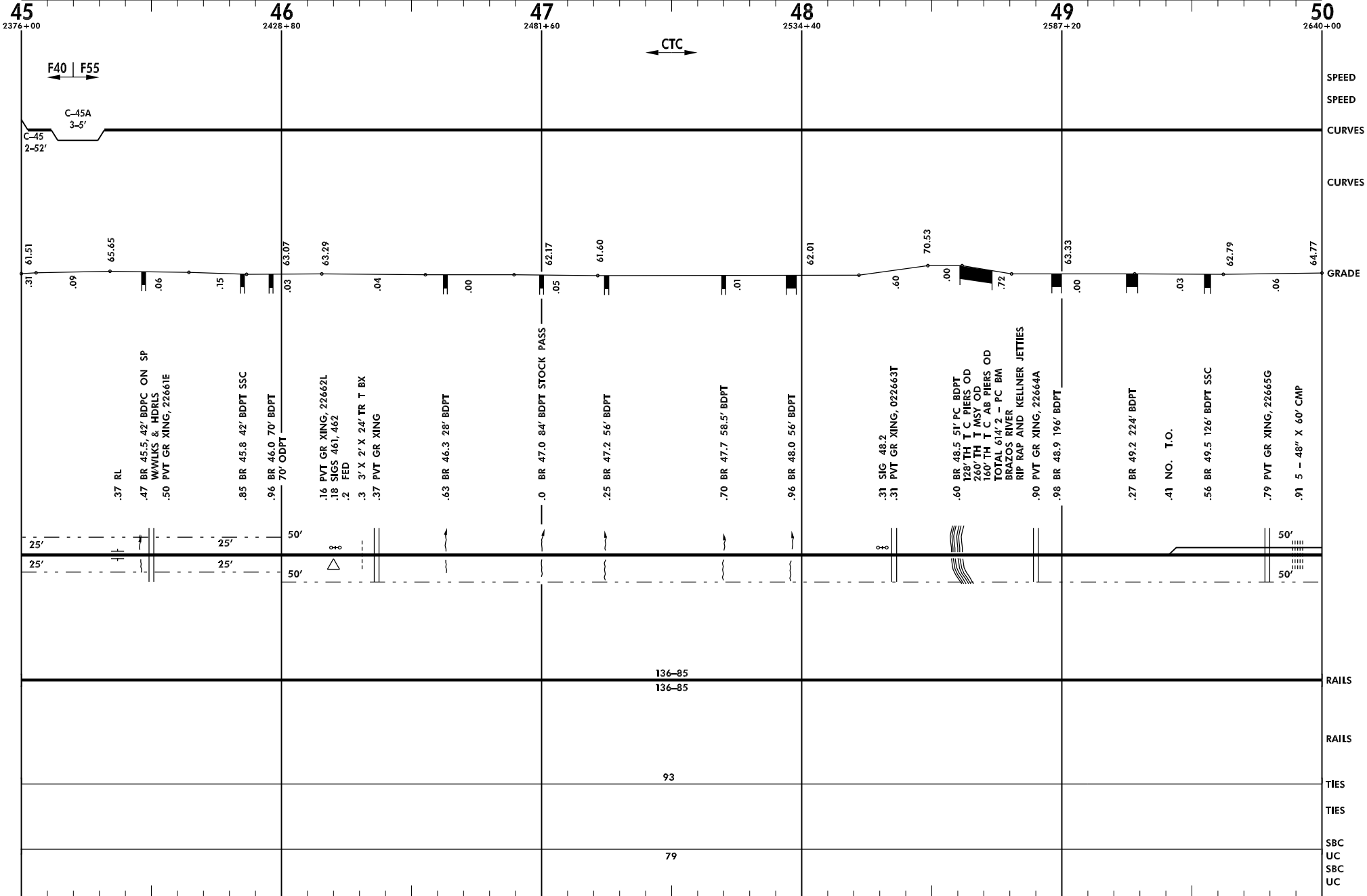

Burlington Northern and Santa Fe Railway Company

GAL010.DGN

Revised: 11/20/1998

Galveston Subdivision

← Galveston, TX

Line Segment 7500

Temple, TX →

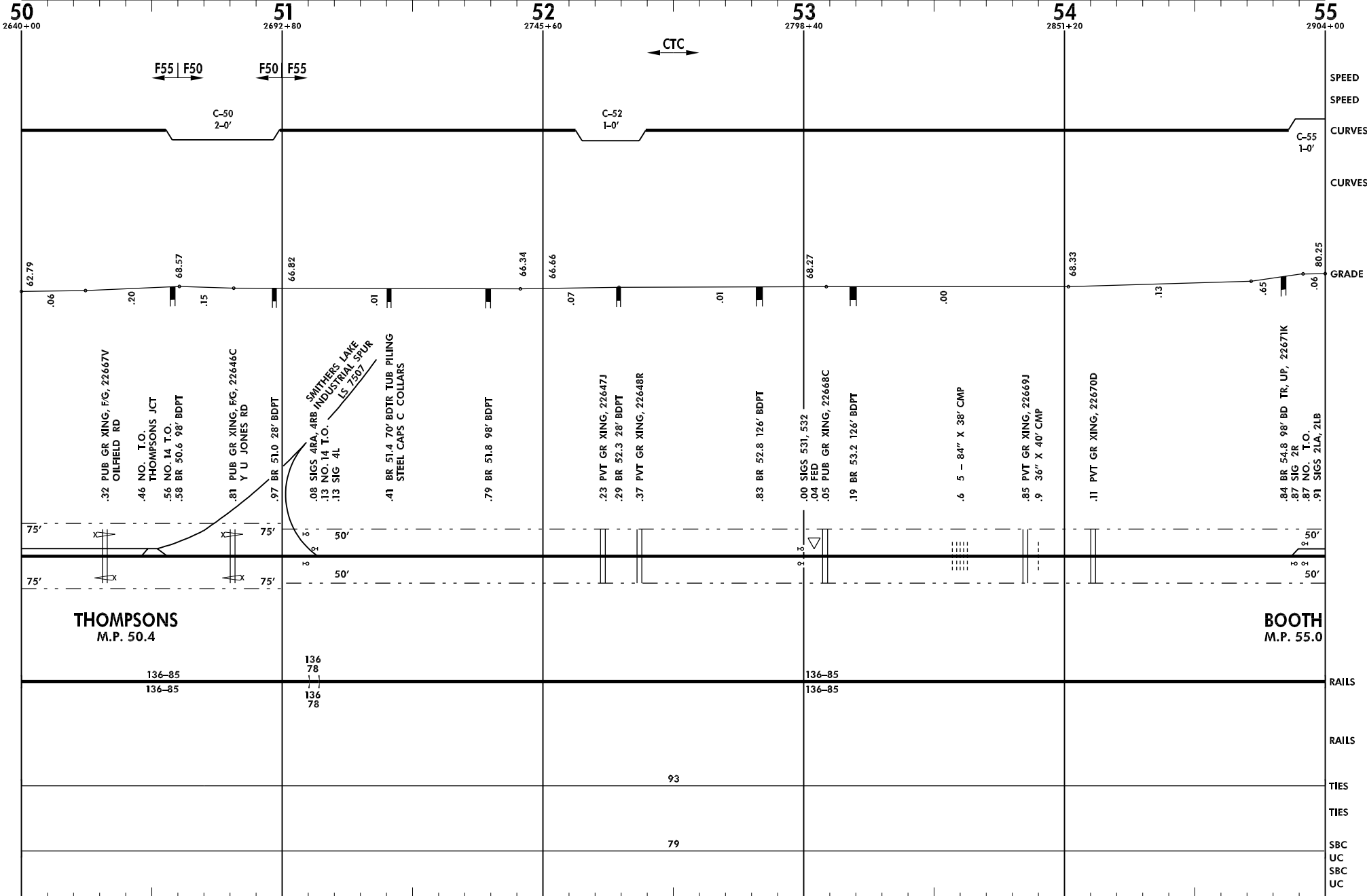

← Galveston, TX

Line Segment 7500

Temple, TX →

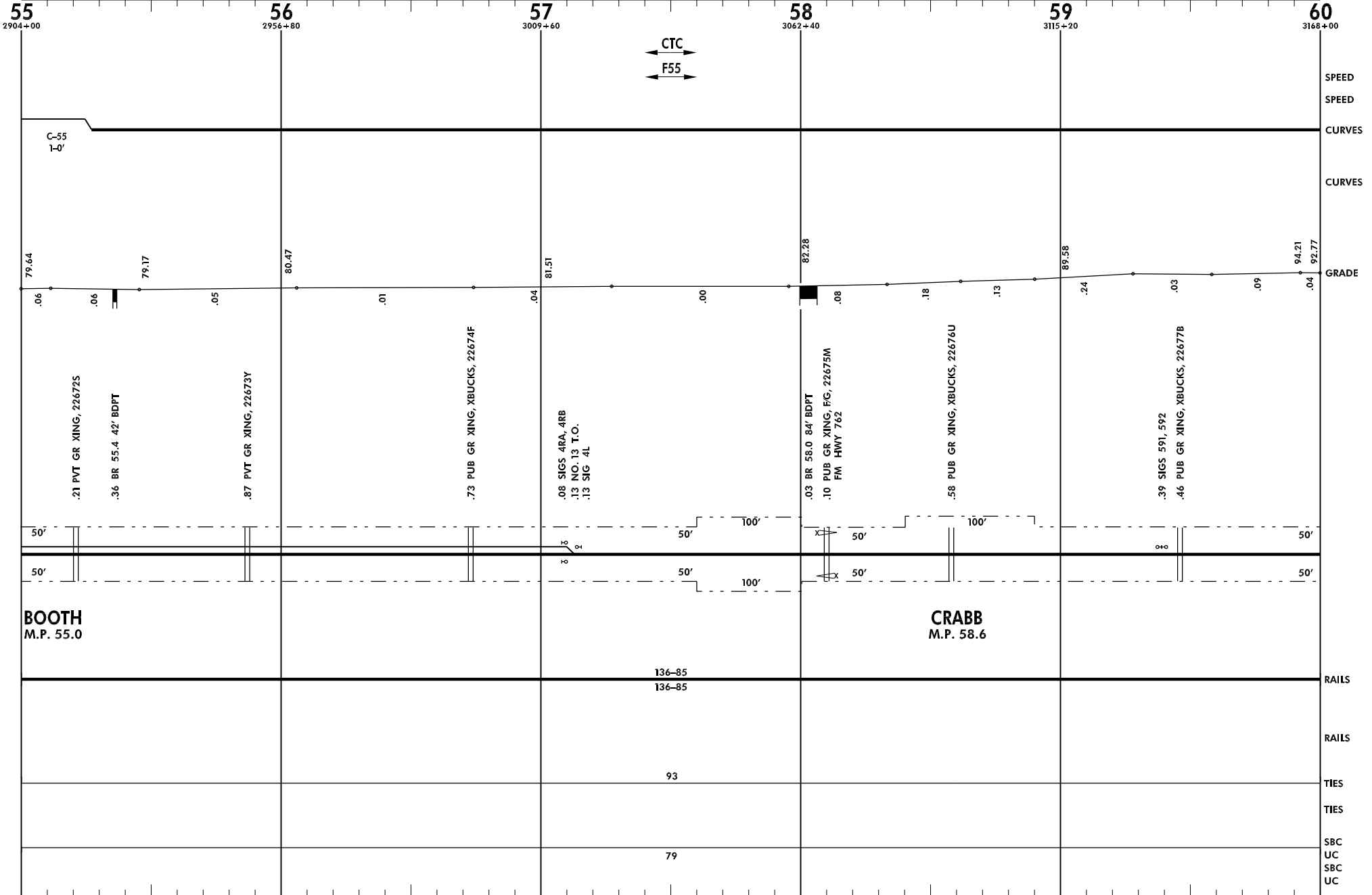

← Galveston, TX

Line Segment 7500

Temple, TX →

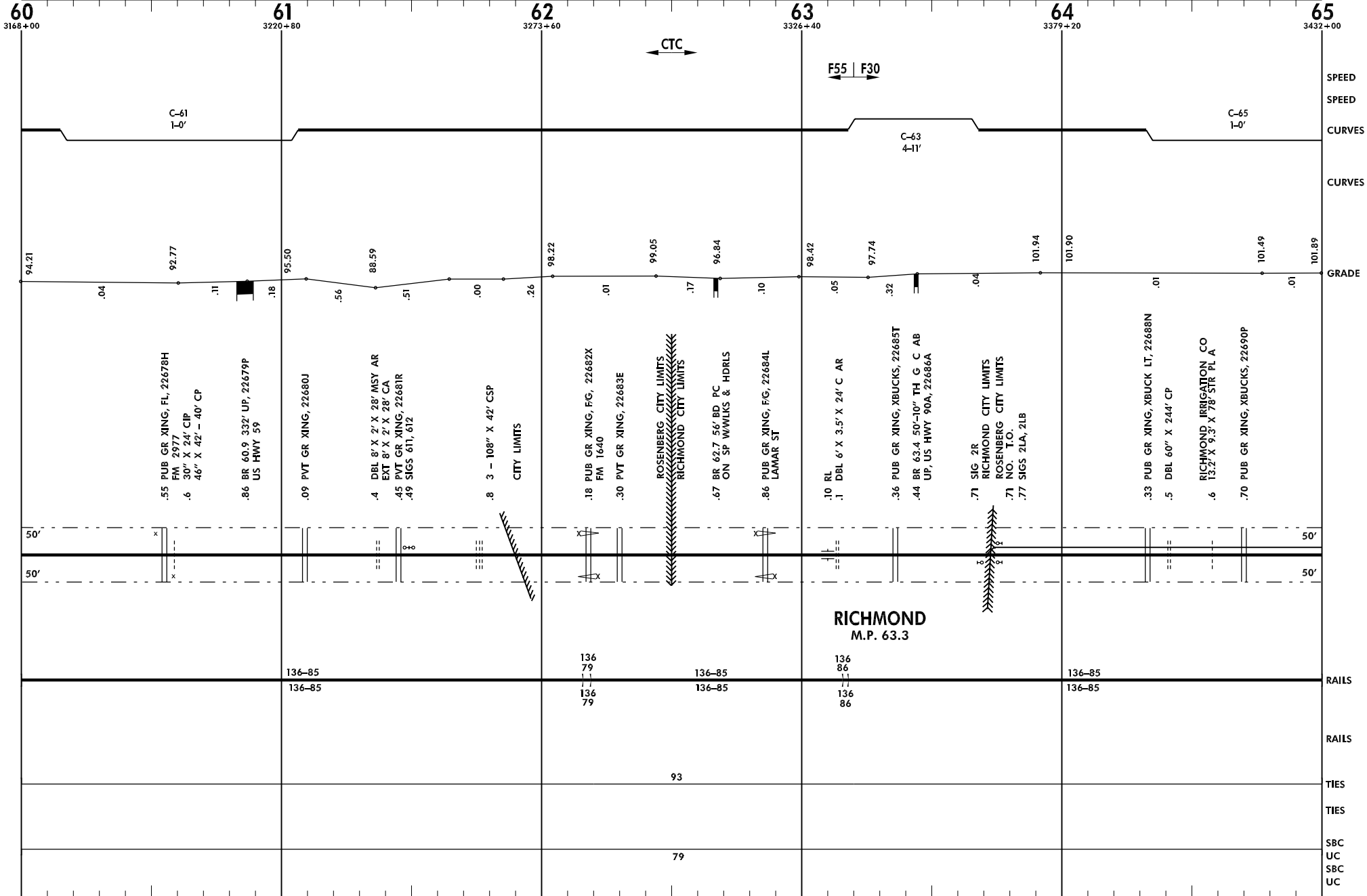

← Galveston, TX

Line Segment 7500

Temple, TX →

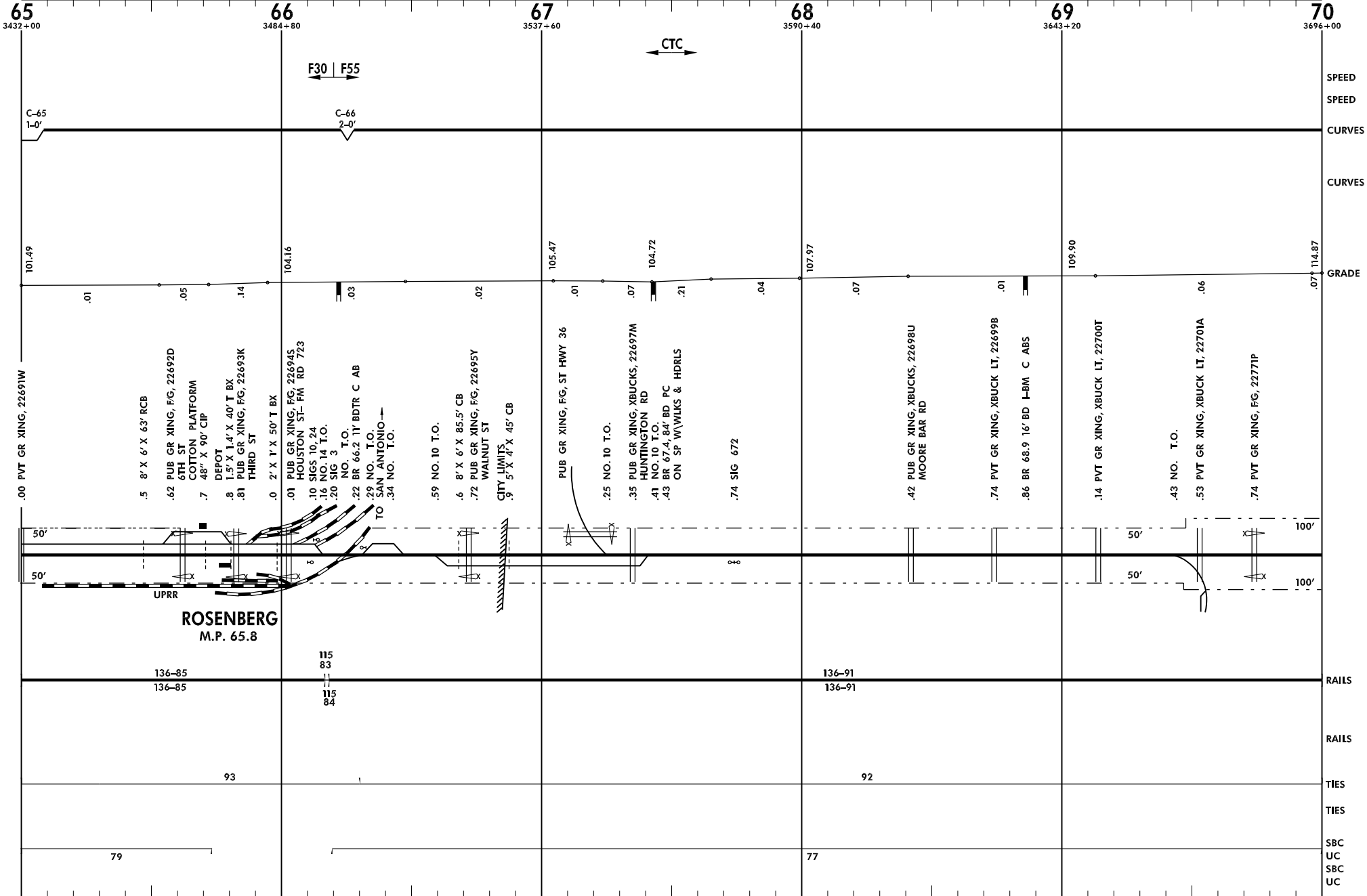

← Temple, TX

Line Segment 7500

Galveston, TX →

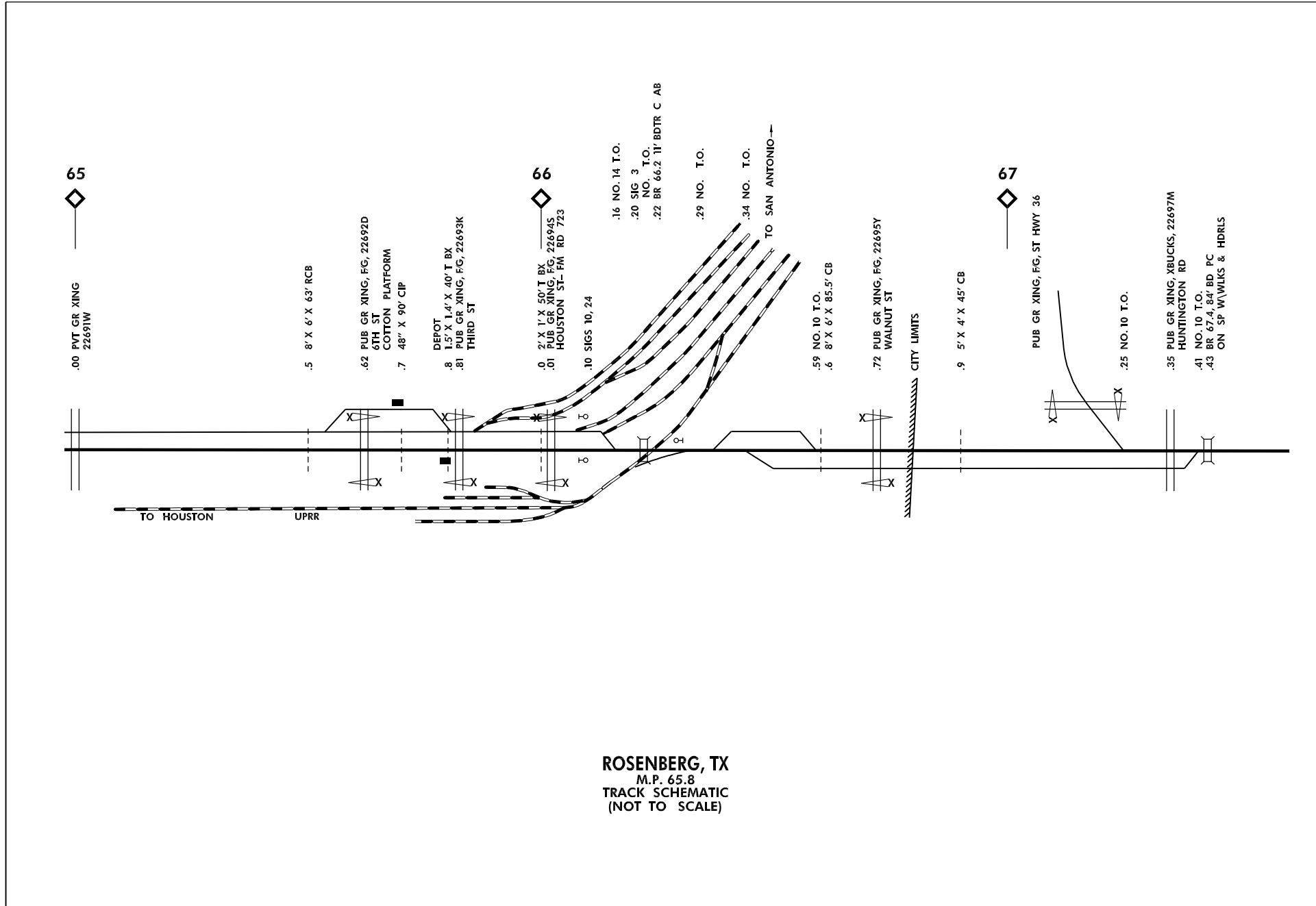

ROSENBERG, TX
 M.P. 65.8
 TRACK SCHEMATIC
 (NOT TO SCALE)

← Galveston, TX

Line Segment 7500

Temple, TX →

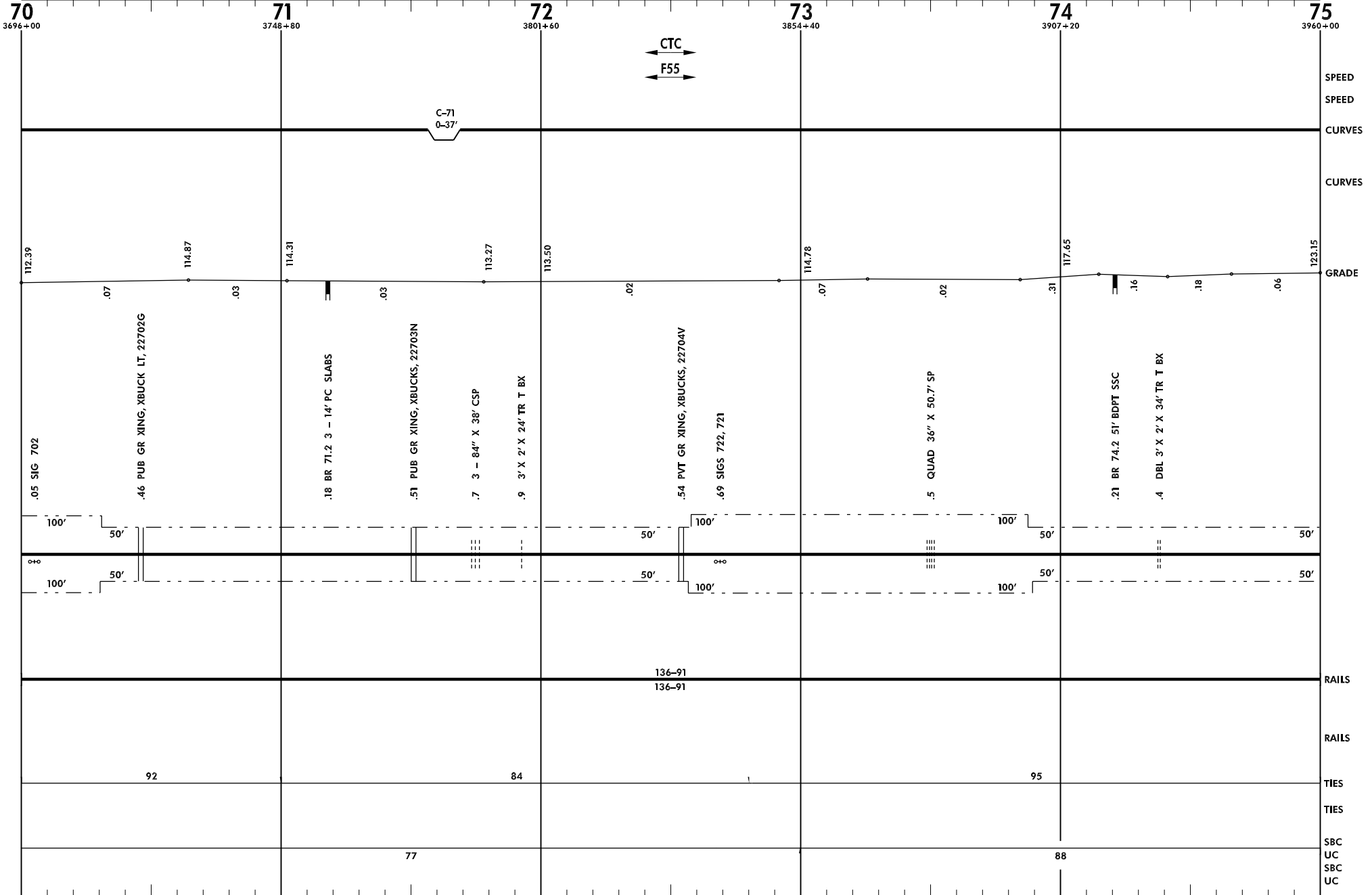

← Galveston, TX

Line Segment 7500

Temple, TX →

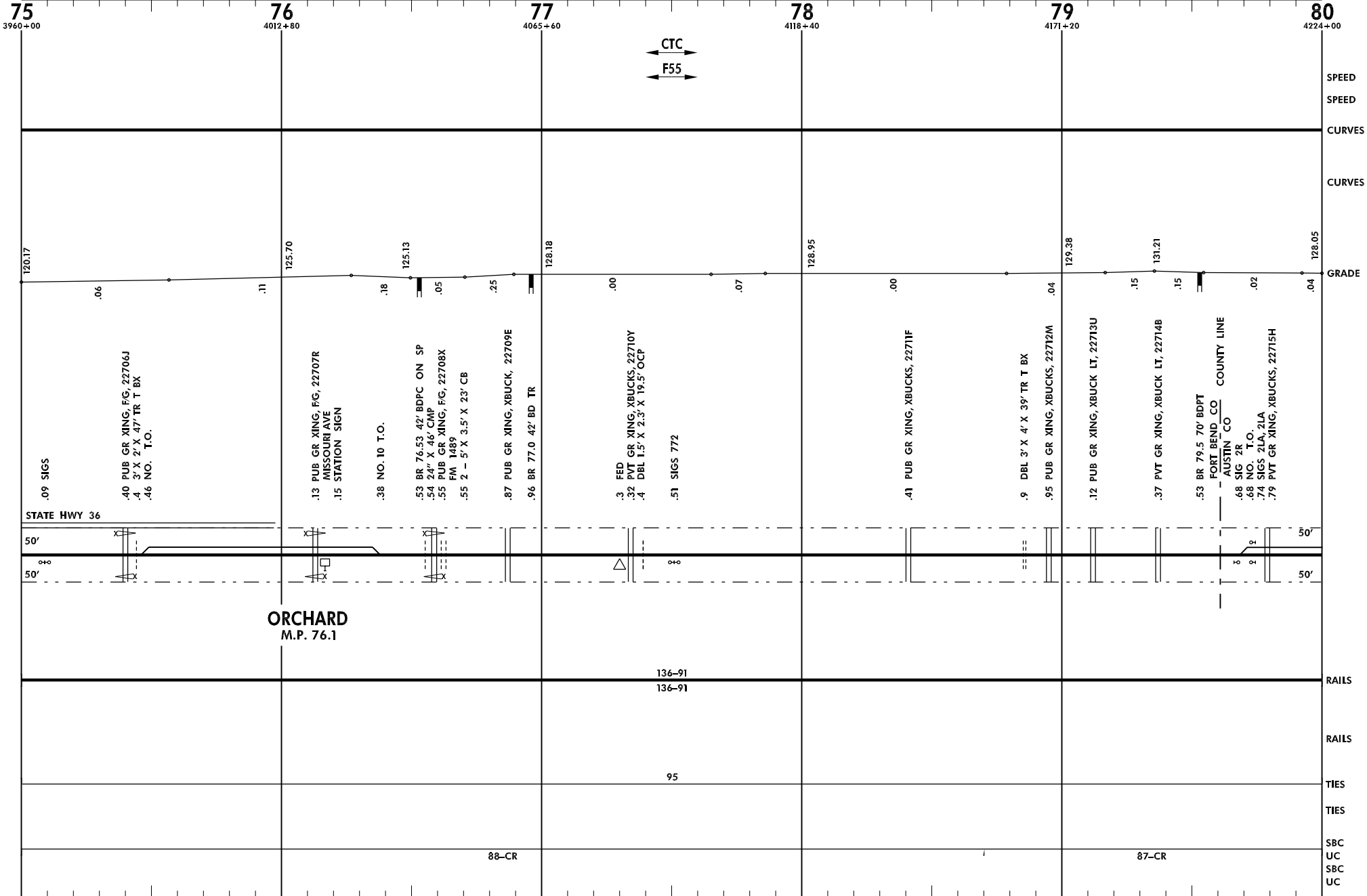

← Galveston, TX

Line Segment 7500

Temple, TX →

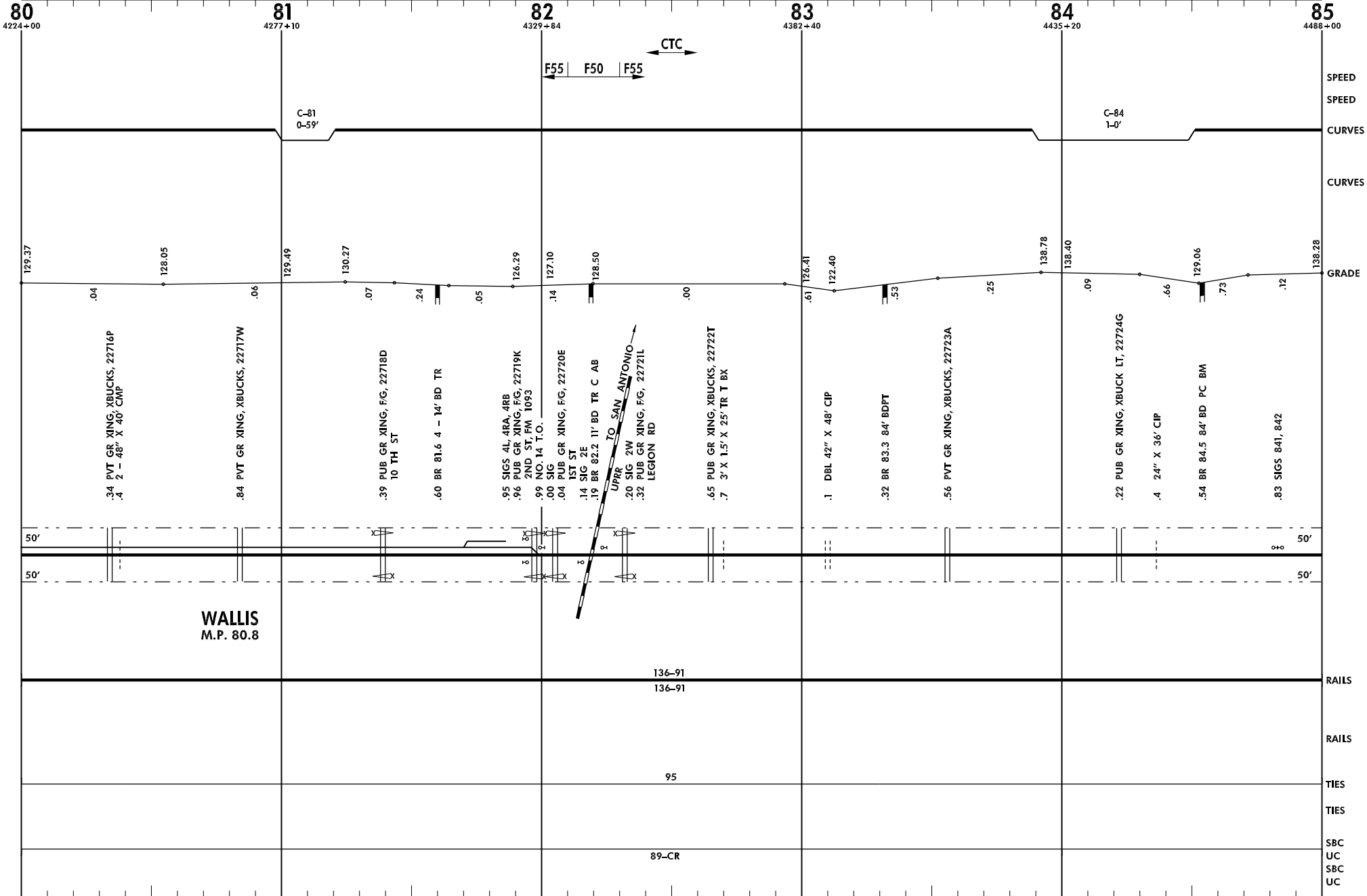

WALLIS
M.P. 80.8

← Galveston, TX

Line Segment 7500

Temple, TX →

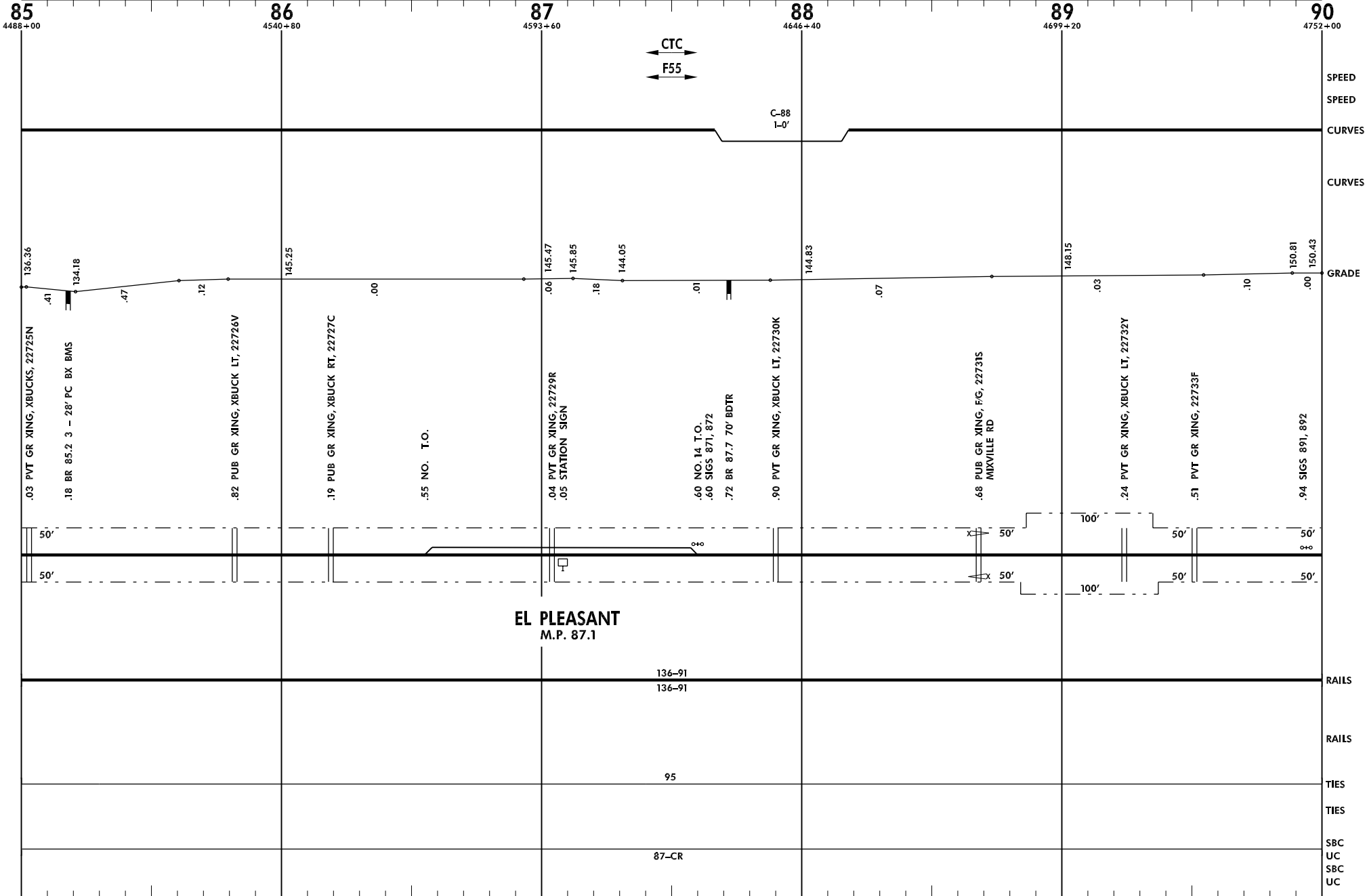

← Galveston, TX

Line Segment 7500

Temple, TX →

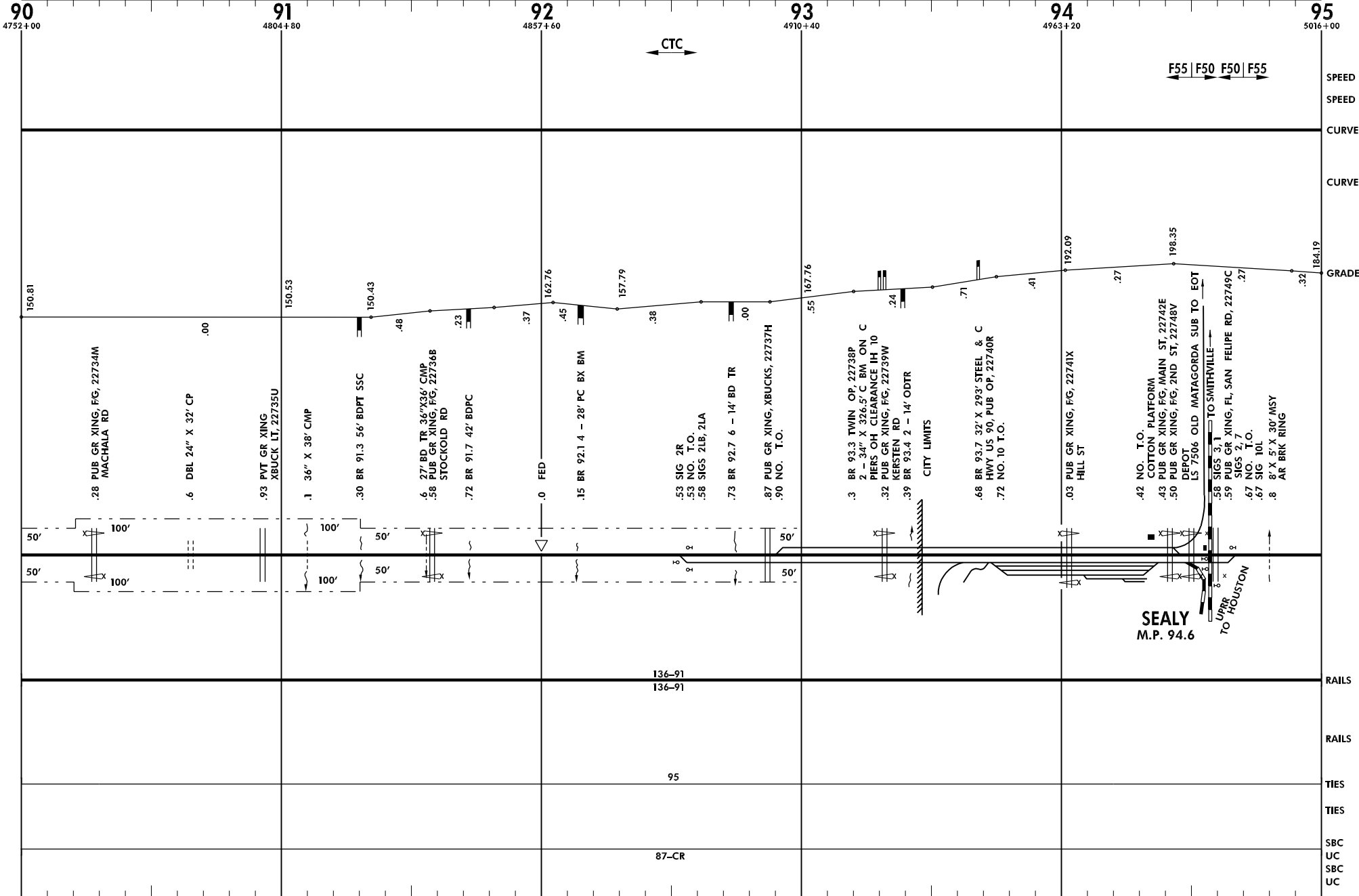

Burlington Northern and Santa Fe Railway Company

GAL019.DGN

Revised: 11/20/1998

Galveston Subdivision

← Temple, TX

Line Segment 7500

Galveston, TX →

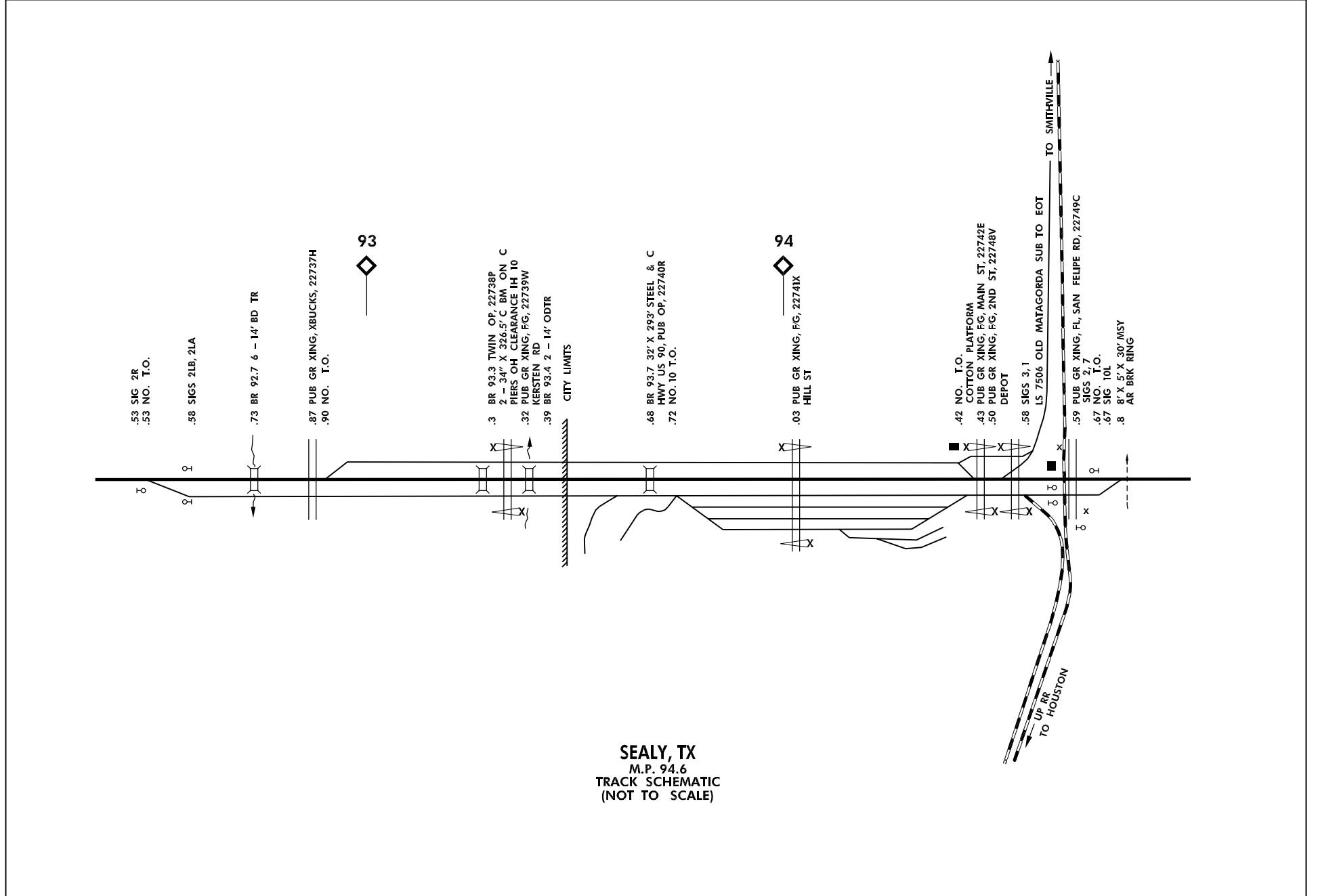

SEALY, TX
 M.P. 94.6
 TRACK SCHEMATIC
 (NOT TO SCALE)

← Galveston, TX

Line Segment 7500

Temple, TX →

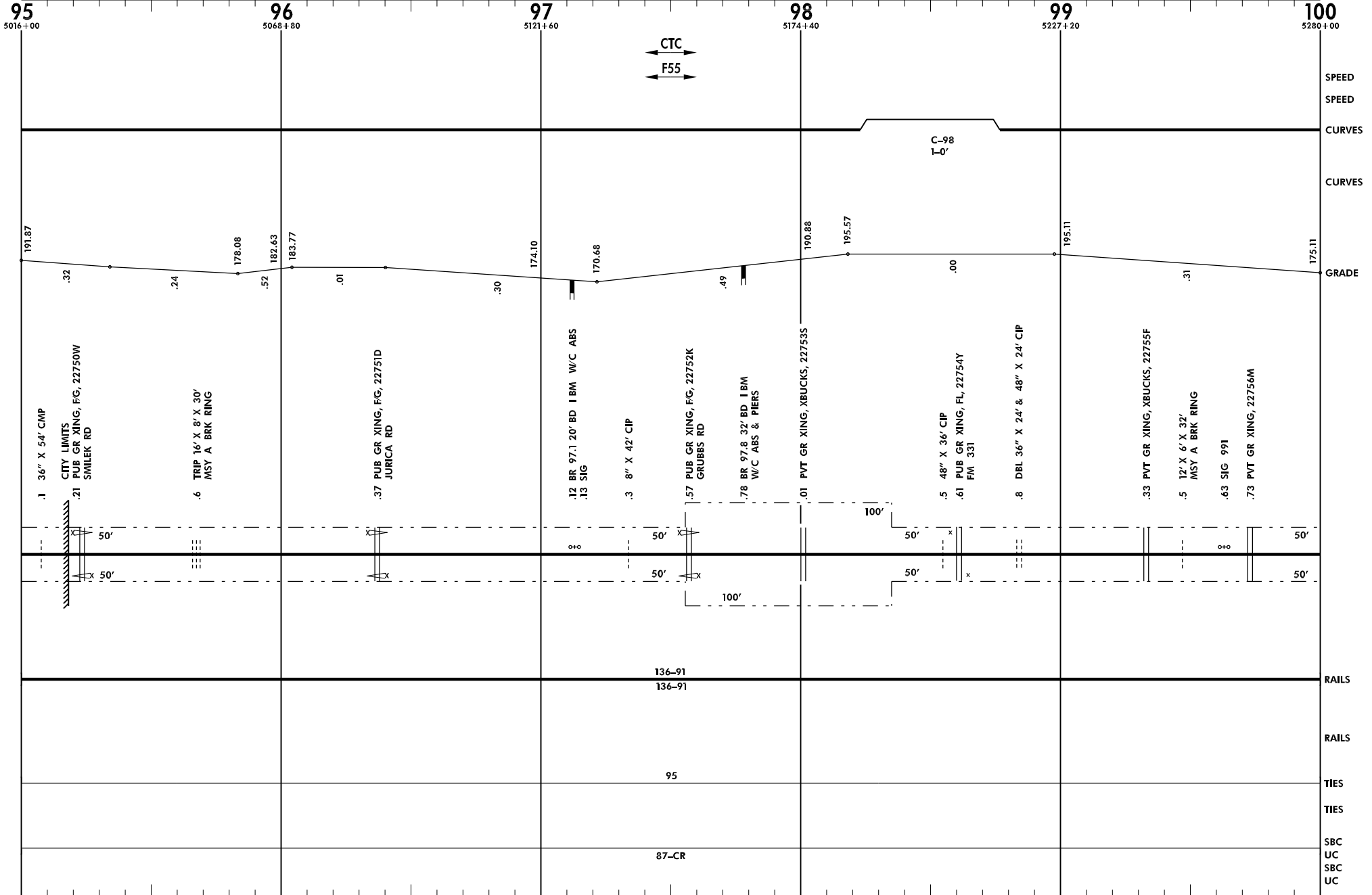

← Galveston, TX

Line Segment 7500

Temple, TX →

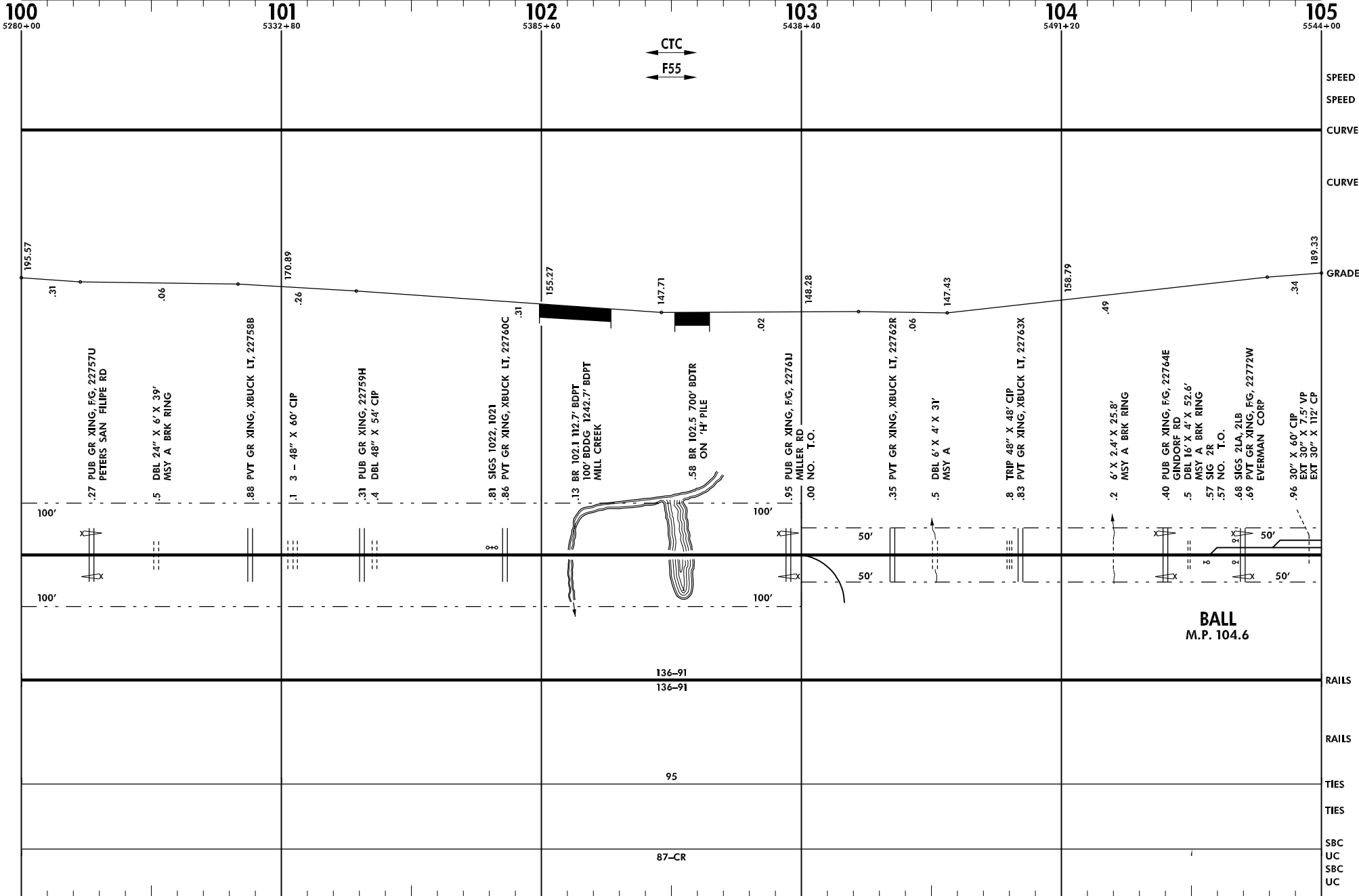

← Galveston, TX

Line Segment 7500

Temple, TX →

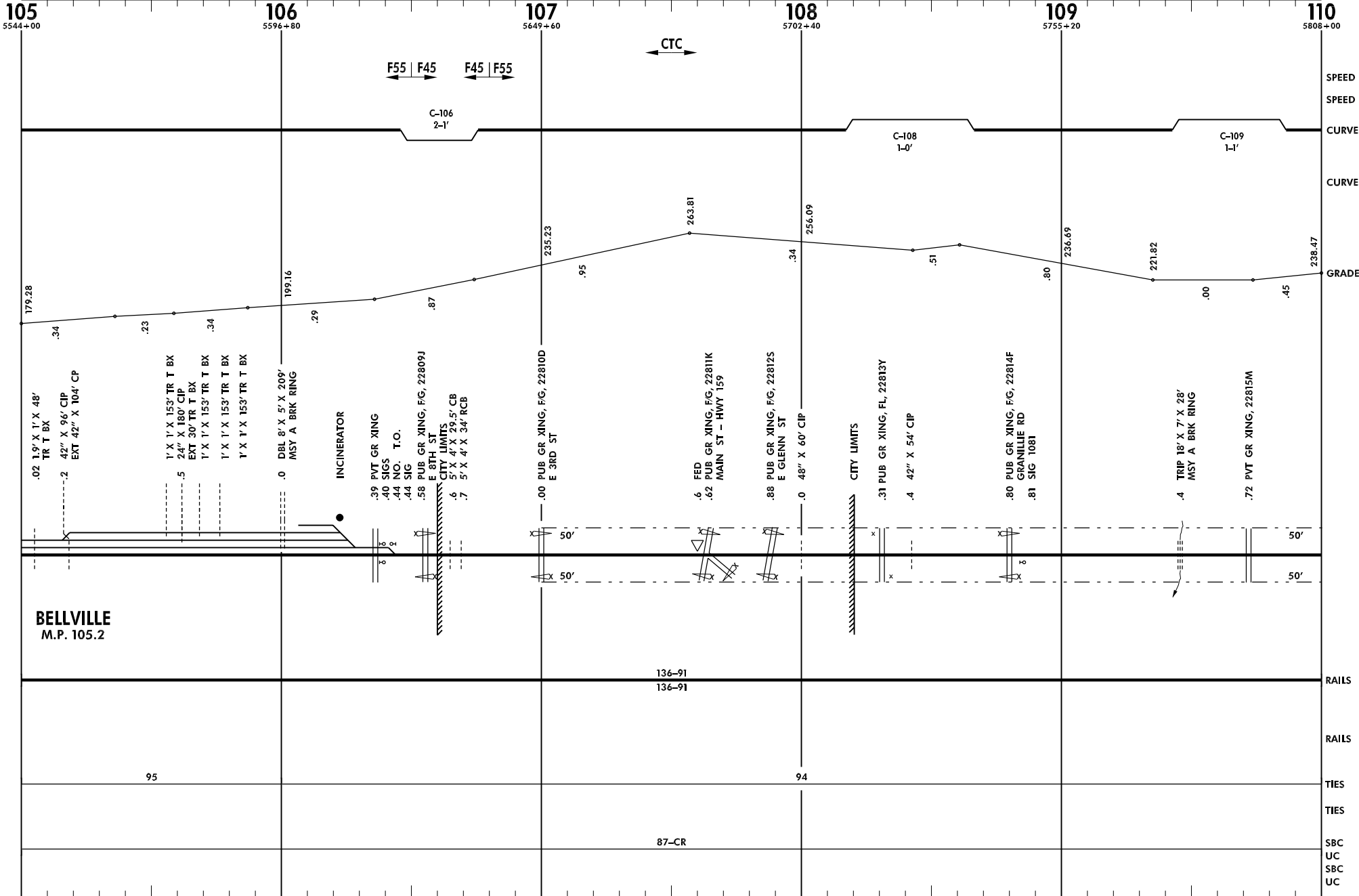

← Galveston, TX

Line Segment 7500

Temple, TX →

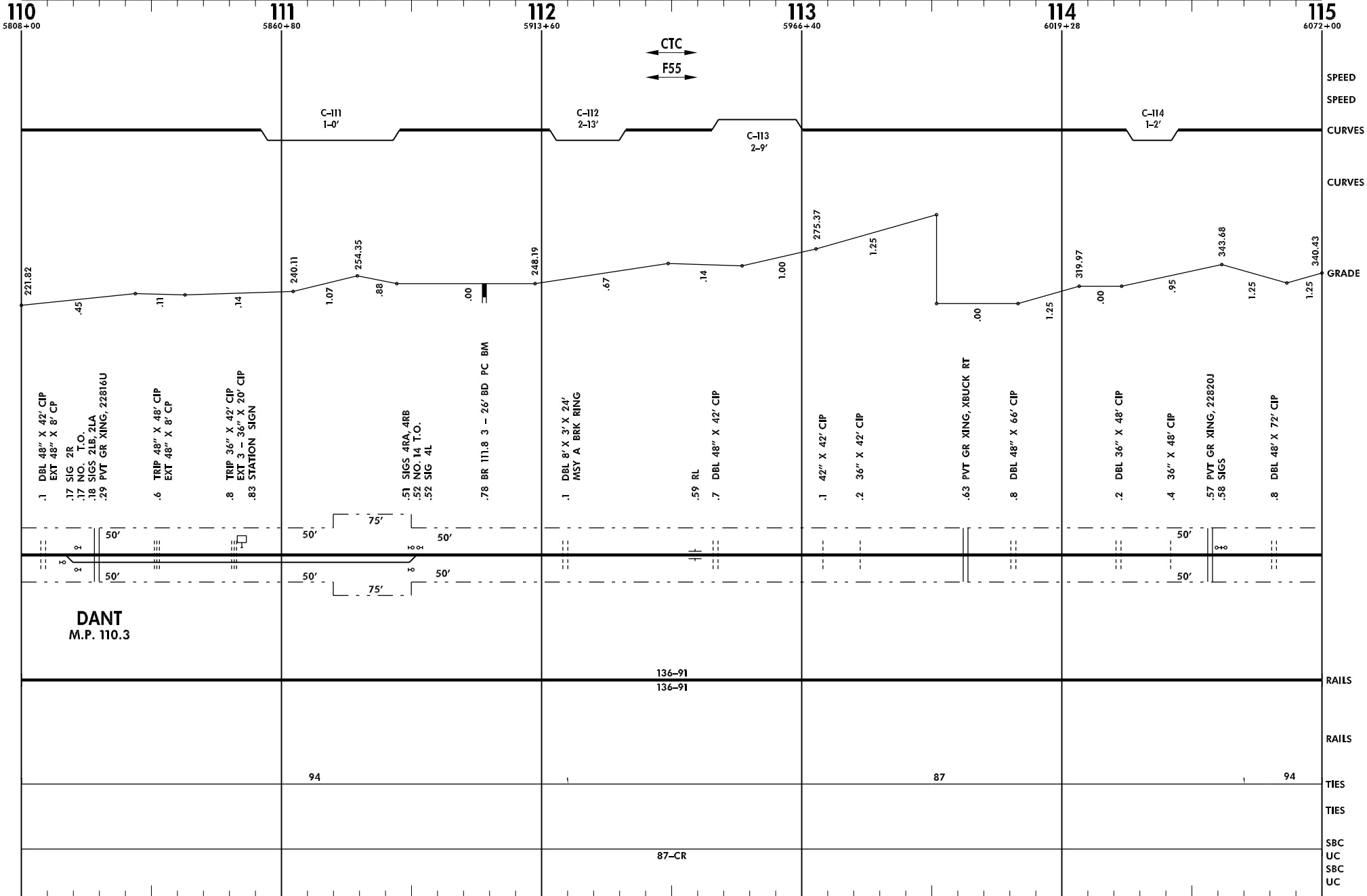

← Galveston, TX

Line Segment 7500

→ Temple, TX

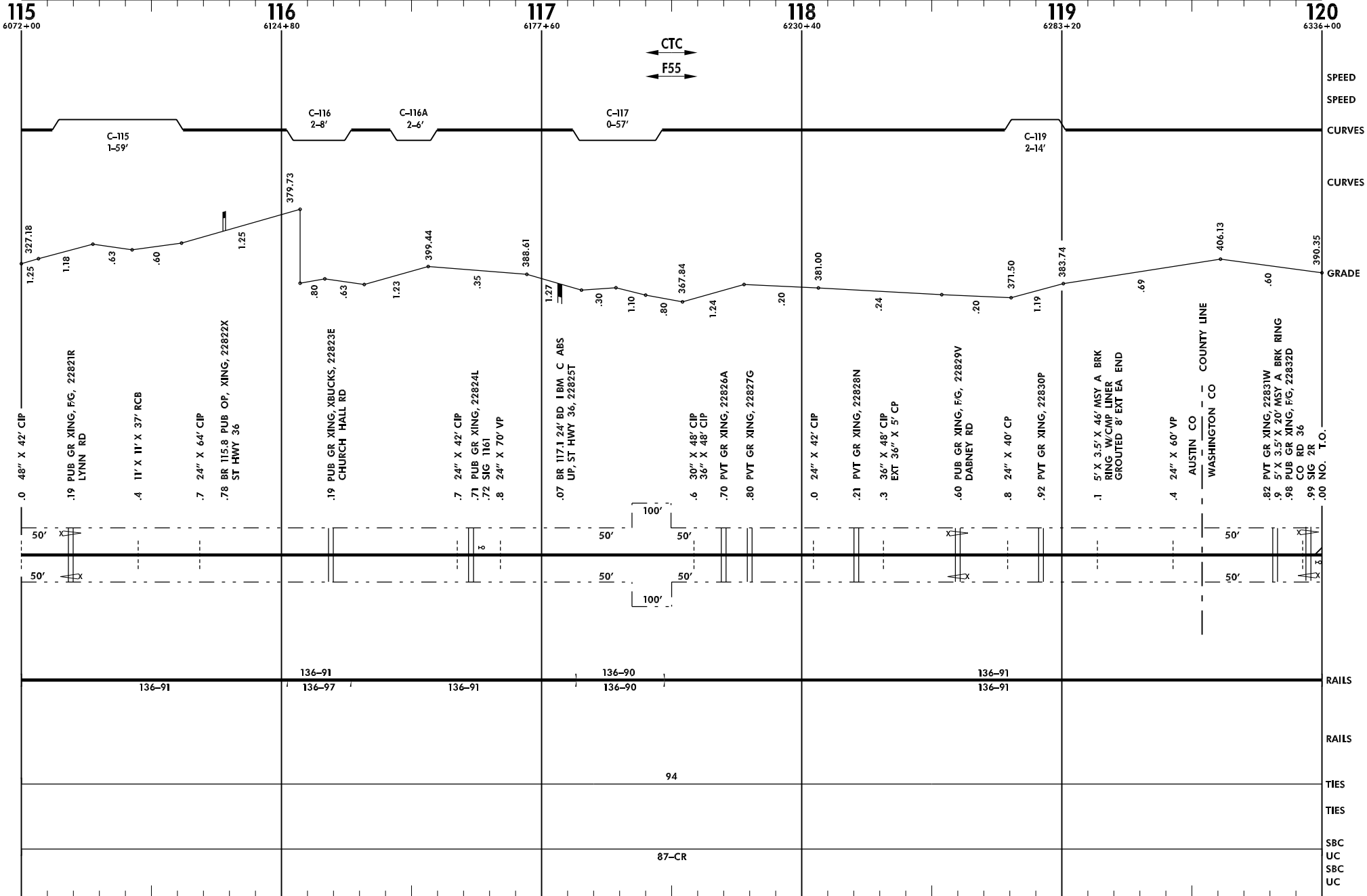

Burlington Northern and Santa Fe Railway Company

GAL024.DGN

Revised: 11/20/1998

Galveston Subdivision

← Galveston, TX

Line Segment 7500

Temple, TX →

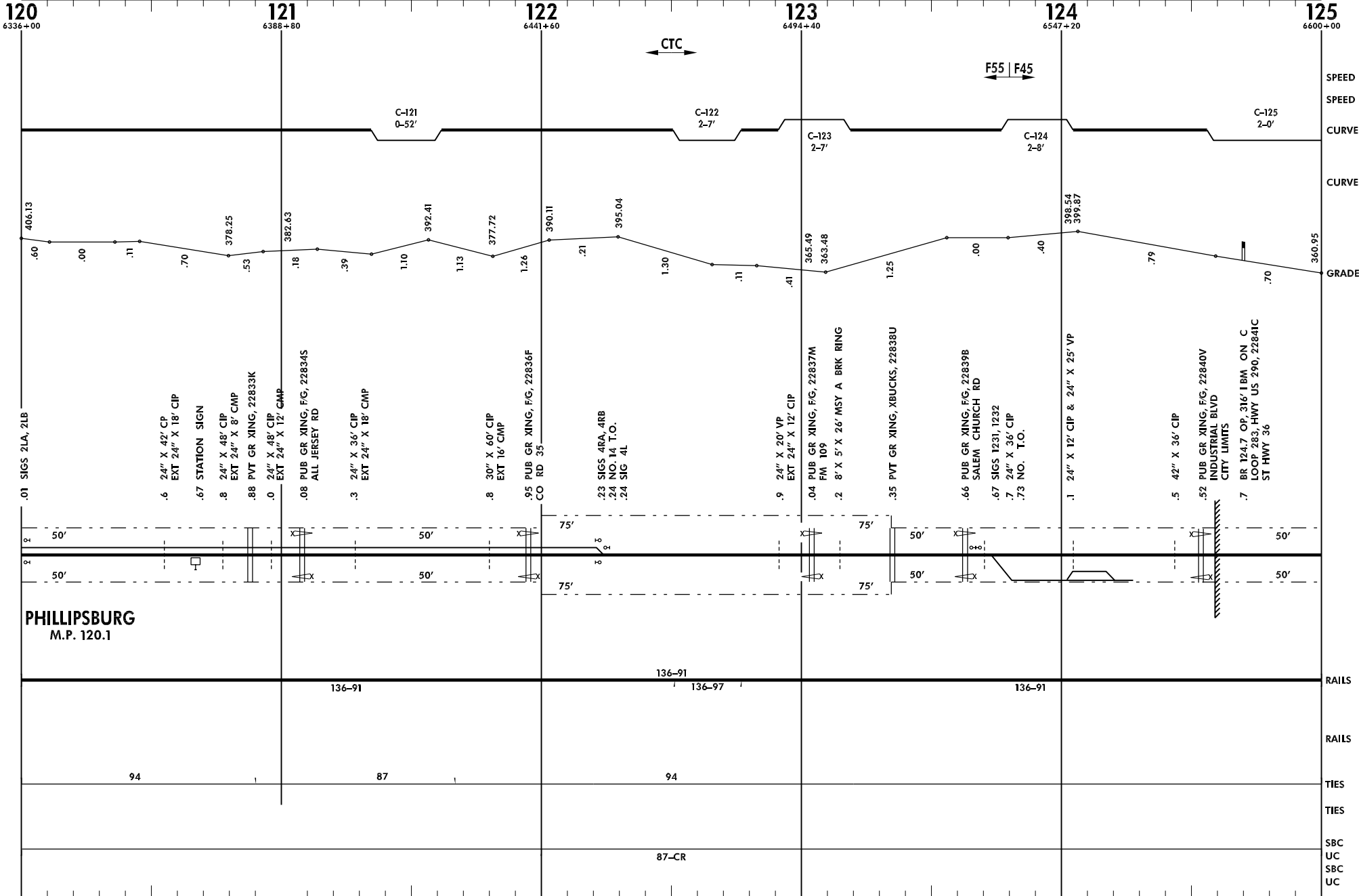

← Galveston, TX

Line Segment 7500

Temple, TX →

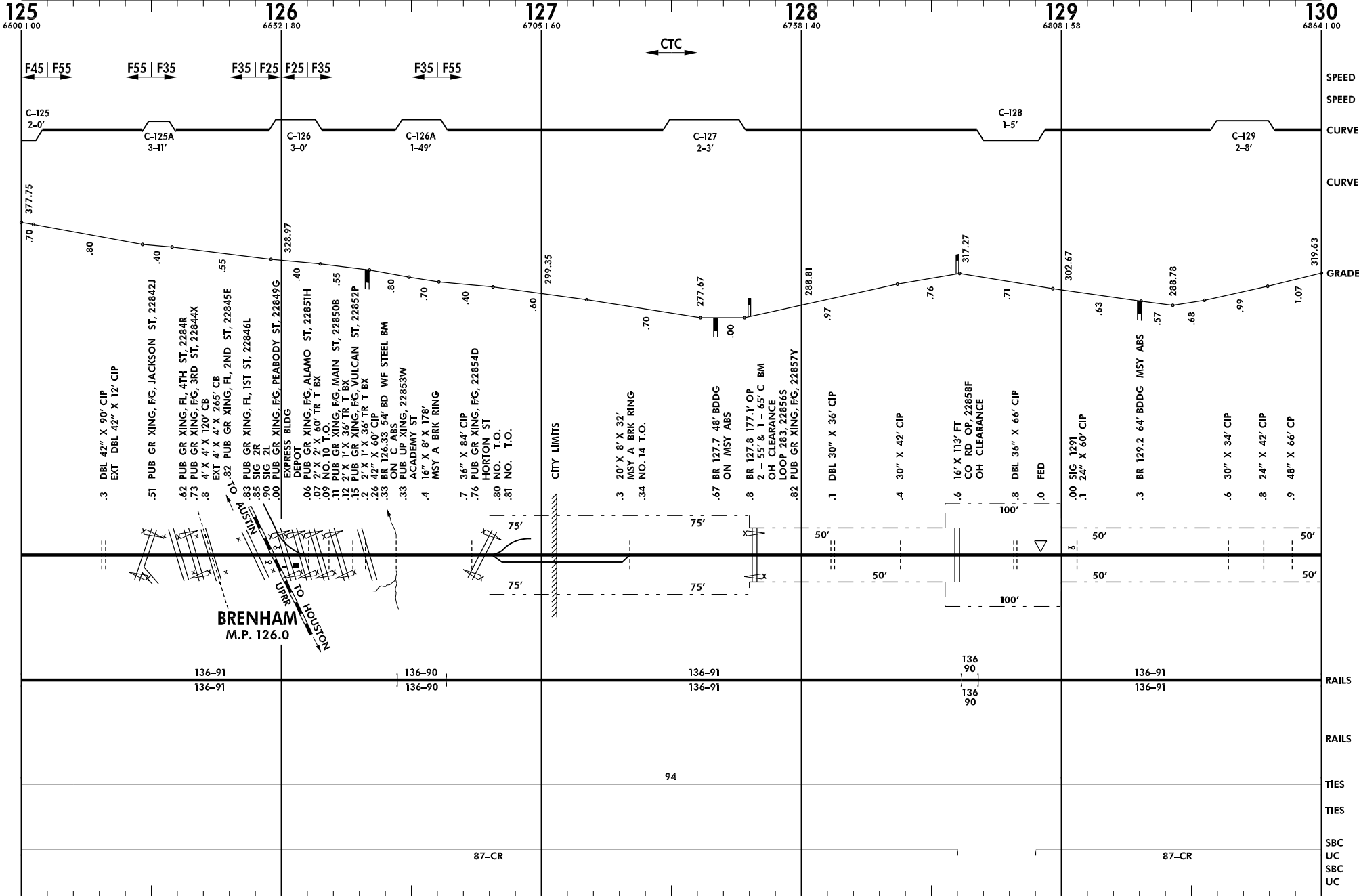

Burlington Northern and Santa Fe Railway Company

GAL026.DGN

Revised: 11/20/1998

Galveston Subdivision

← Galveston, TX

Line Segment 7500

Temple, TX →

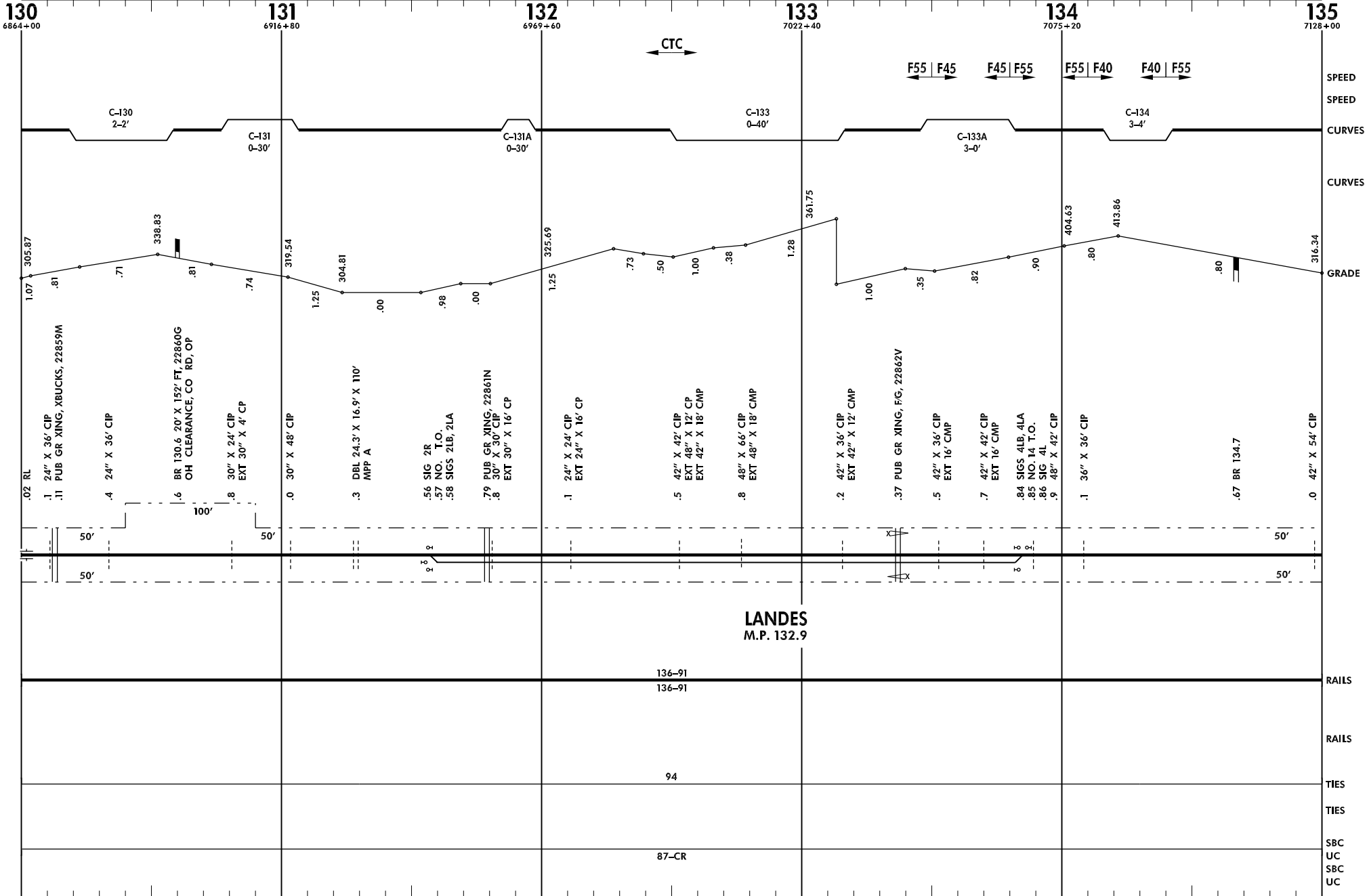

Burlington Northern and Santa Fe Railway Company

GAL027.DGN

Revised: 11/20/1998

Galveston Subdivision

← Galveston, TX

Line Segment 7500

Temple, TX →

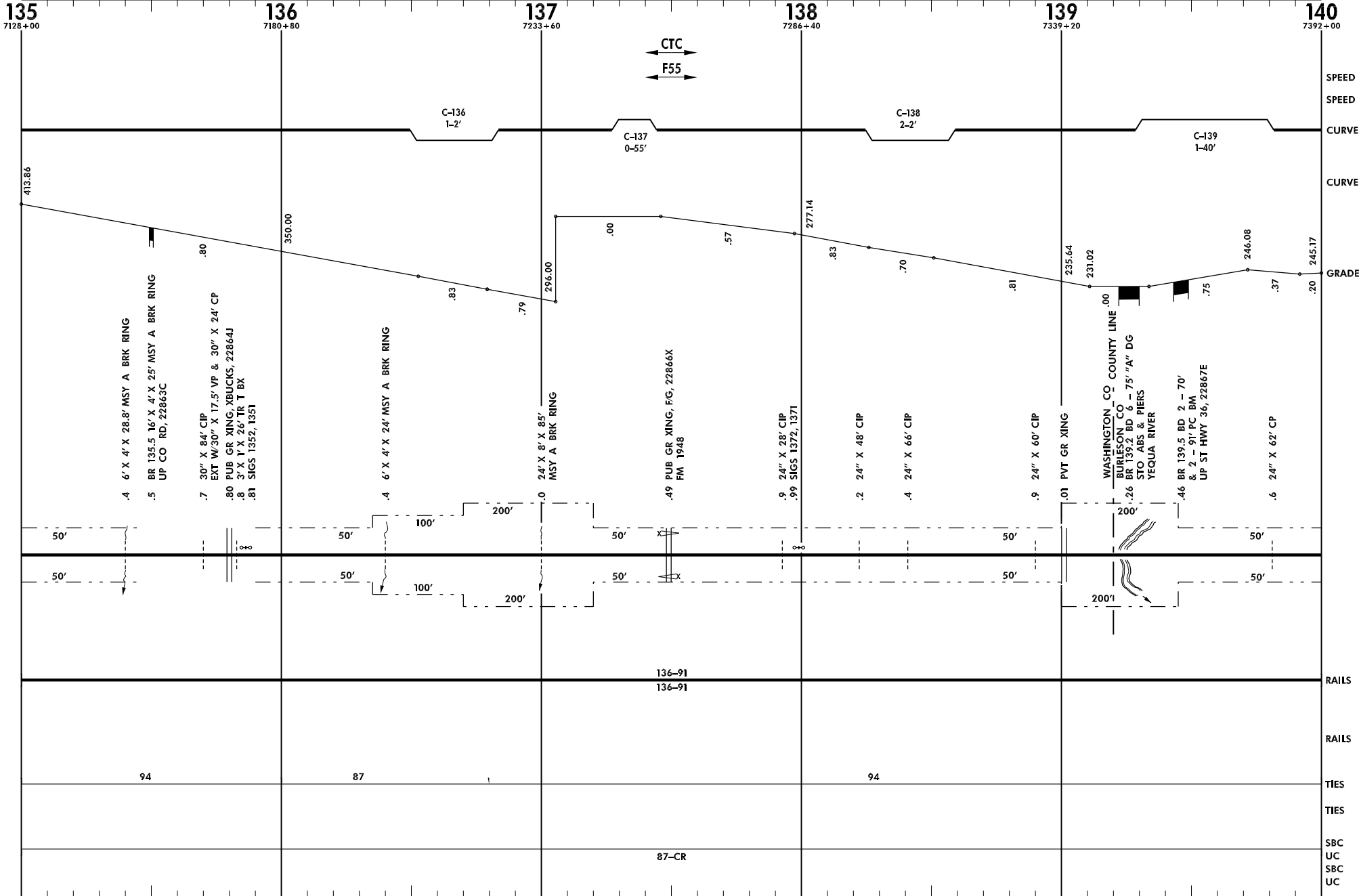

Burlington Northern and Santa Fe Railway Company

GAL028.DGN

Revised: 11/20/1998

Galveston Subdivision

SPEED
 SPEED
 CURVES
 CURVES
 GRADE
 RAILS
 RAILS
 TIES
 TIES
 SBC
 UC
 SBC
 UC

← Galveston, TX

Line Segment 7500

Temple, TX →

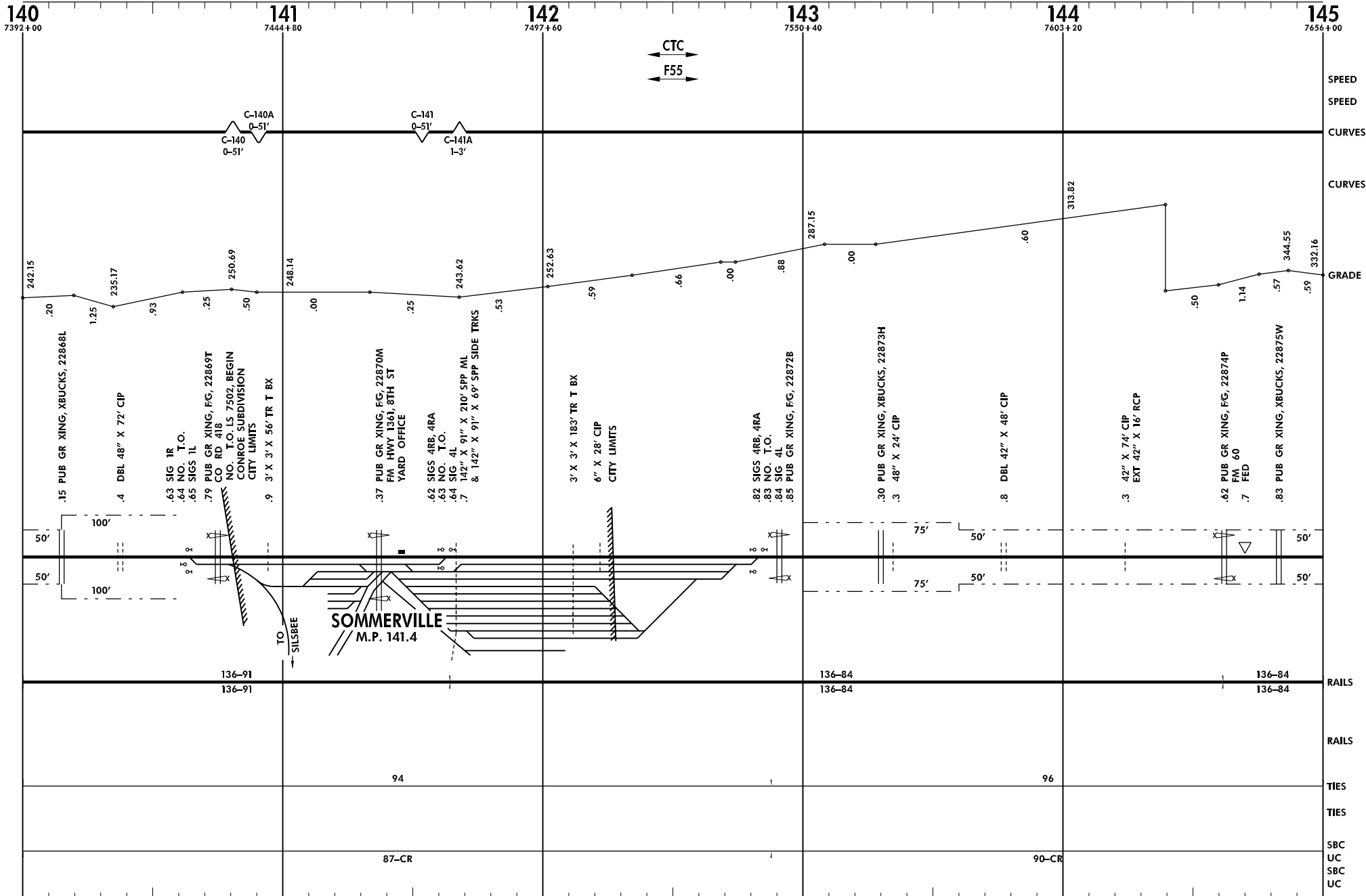

← Temple, TX

Line Segment 7500

Galveston, TX →

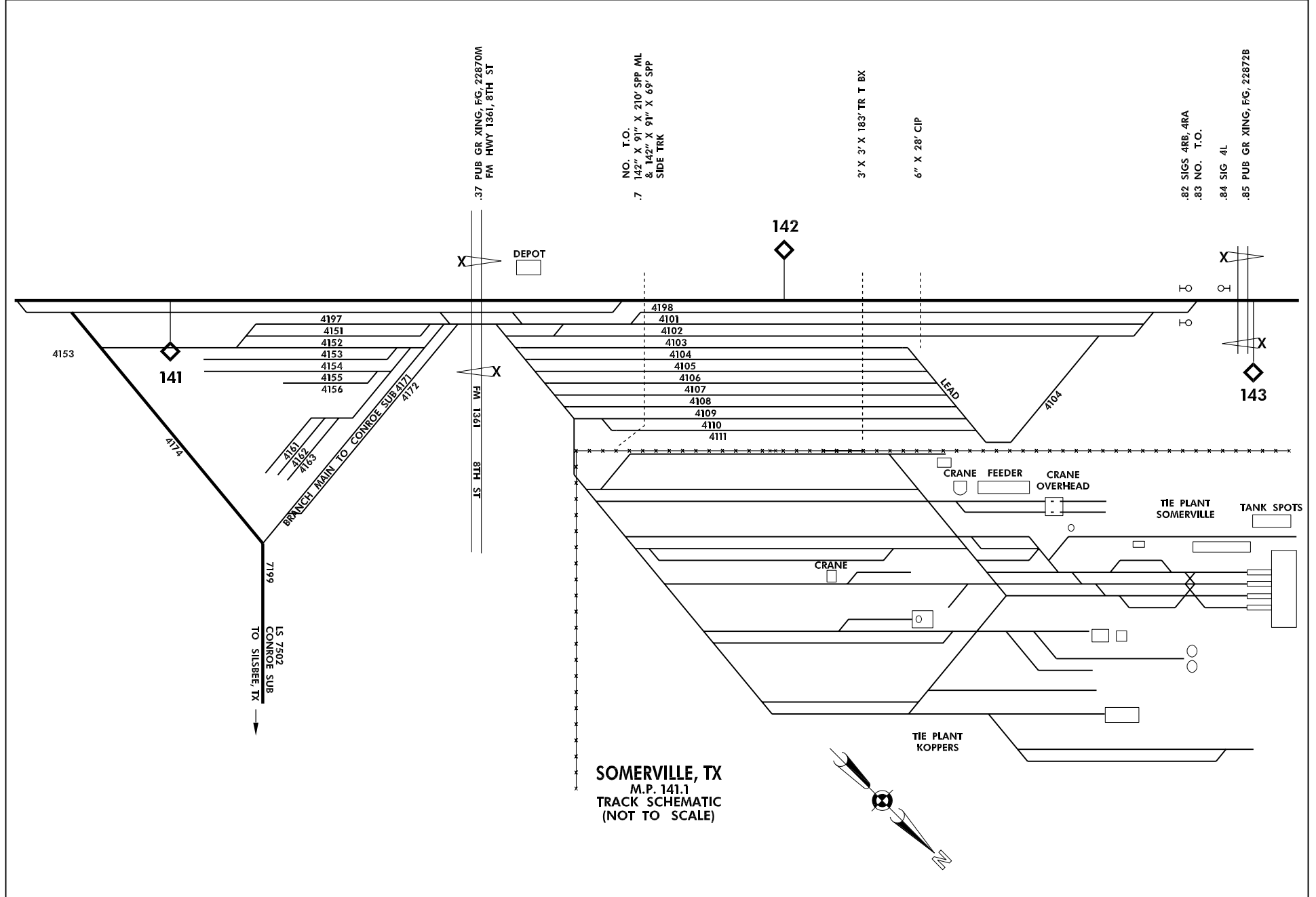

← Galveston, TX

Line Segment 7500

Temple, TX →

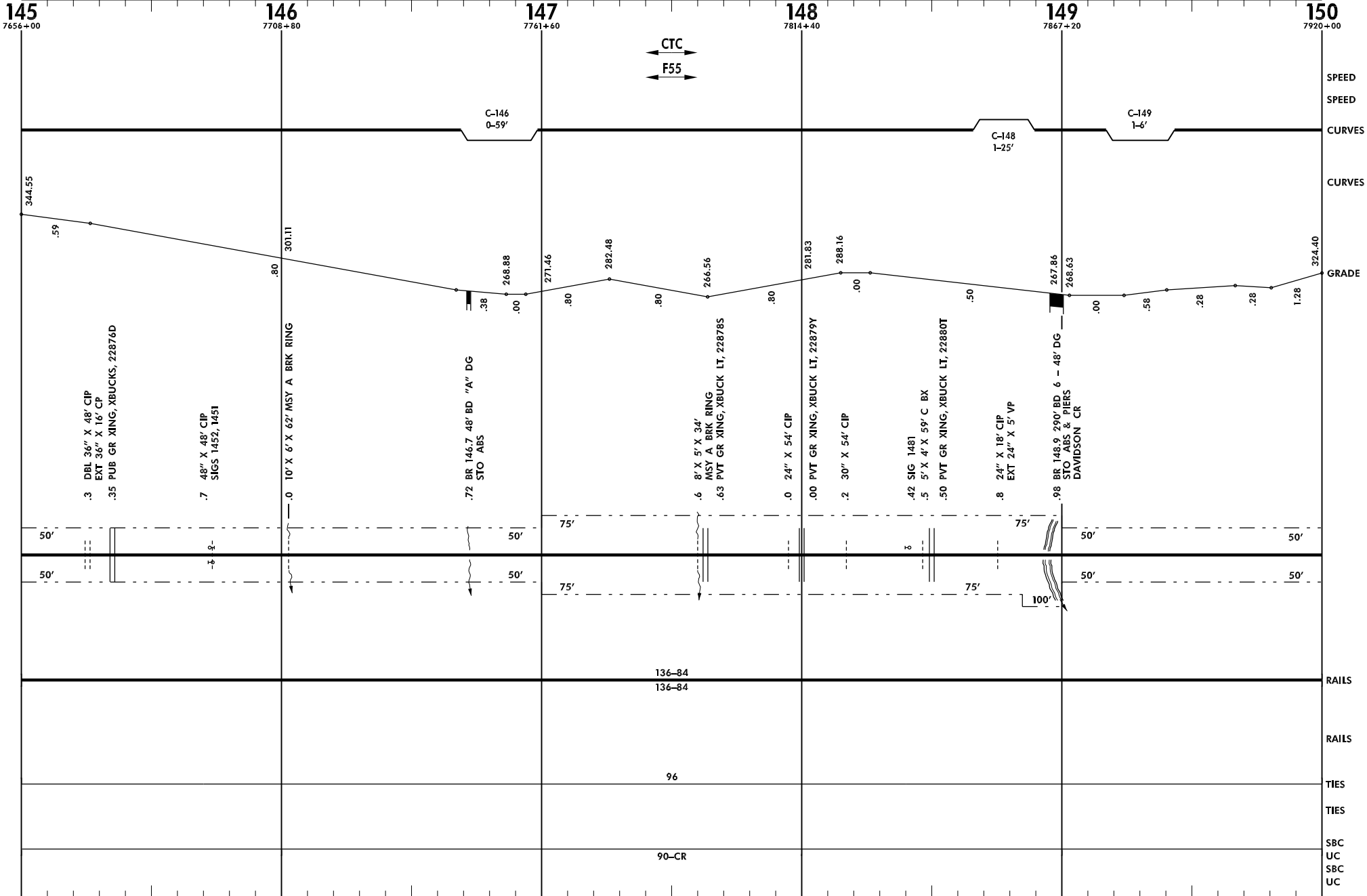

← Galveston, TX

Line Segment 7500

Temple, TX →

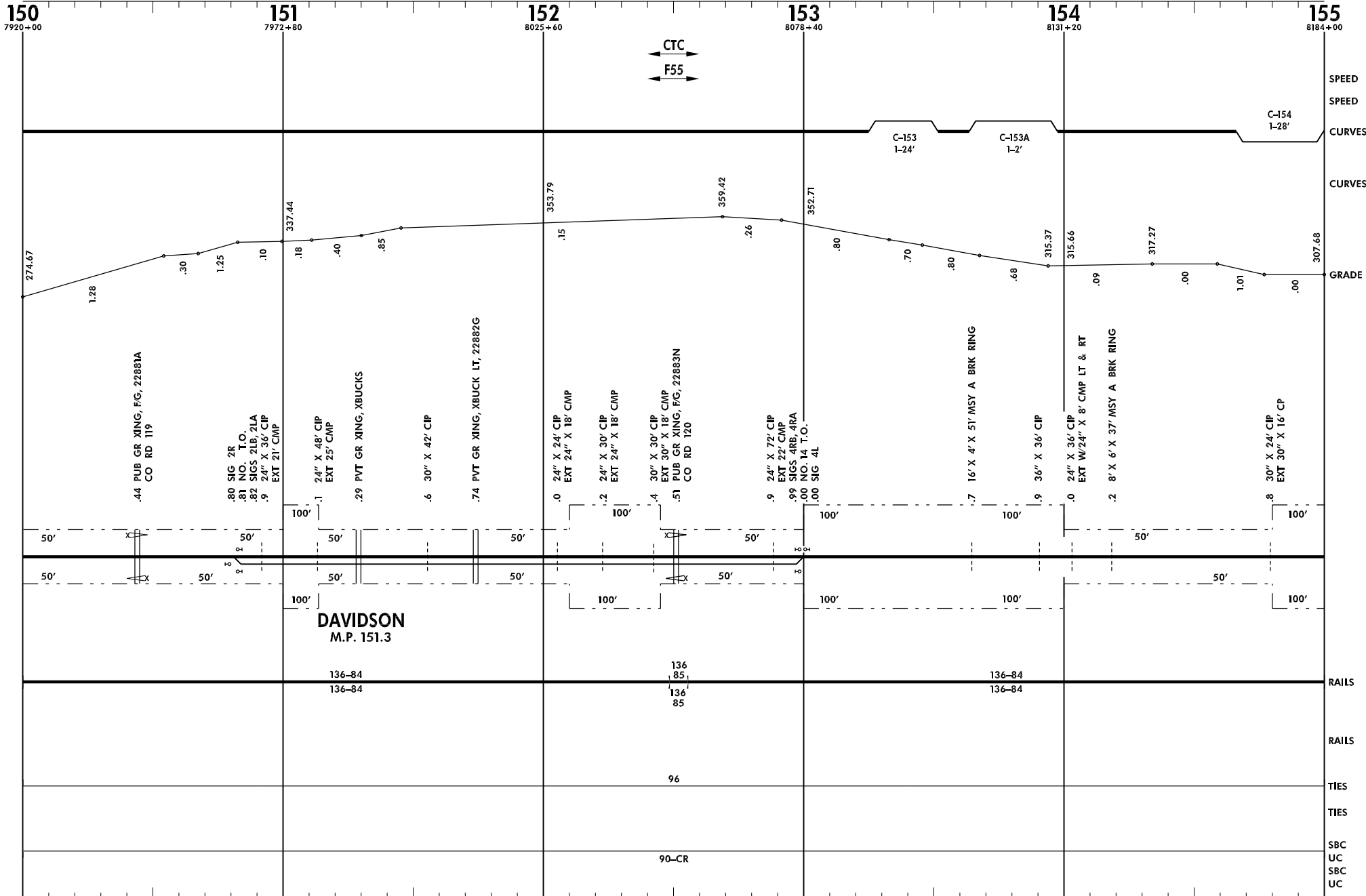

← Galveston, TX

Line Segment 7500

Temple, TX →

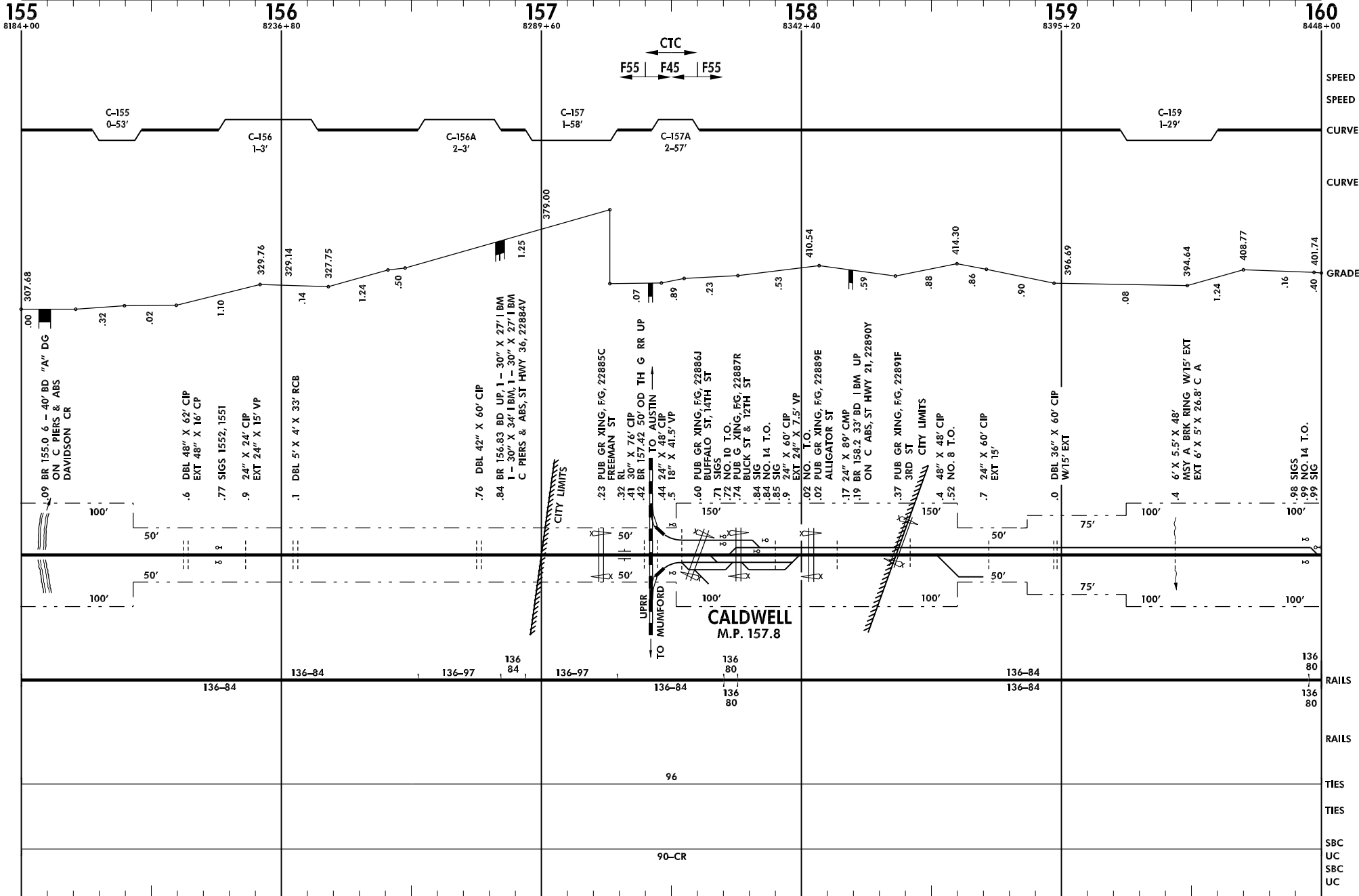

← Temple, TX

Line Segment 7500

Galveston, TX →

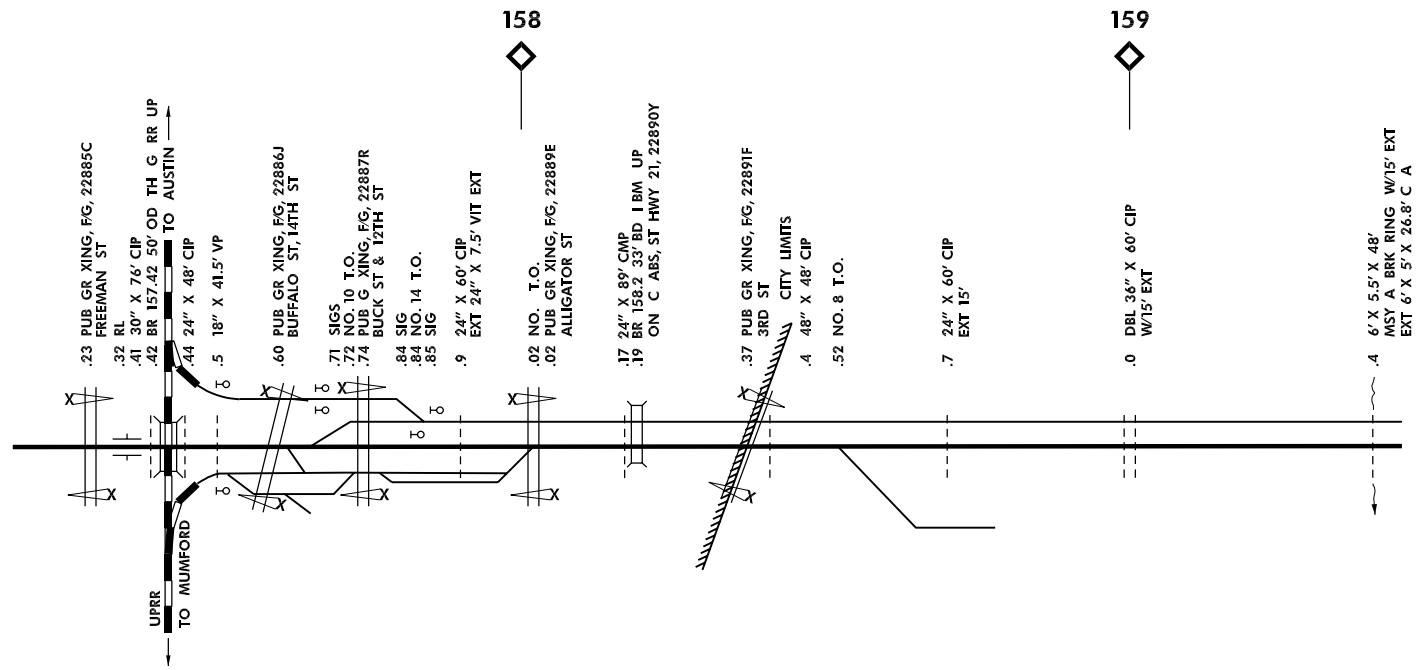

CALDWELL, TX
 M.P. 157.8
 TRACK SCHEMATIC
 (NOT TO SCALE)

← Galveston, TX

Line Segment 7500

→ Temple, TX

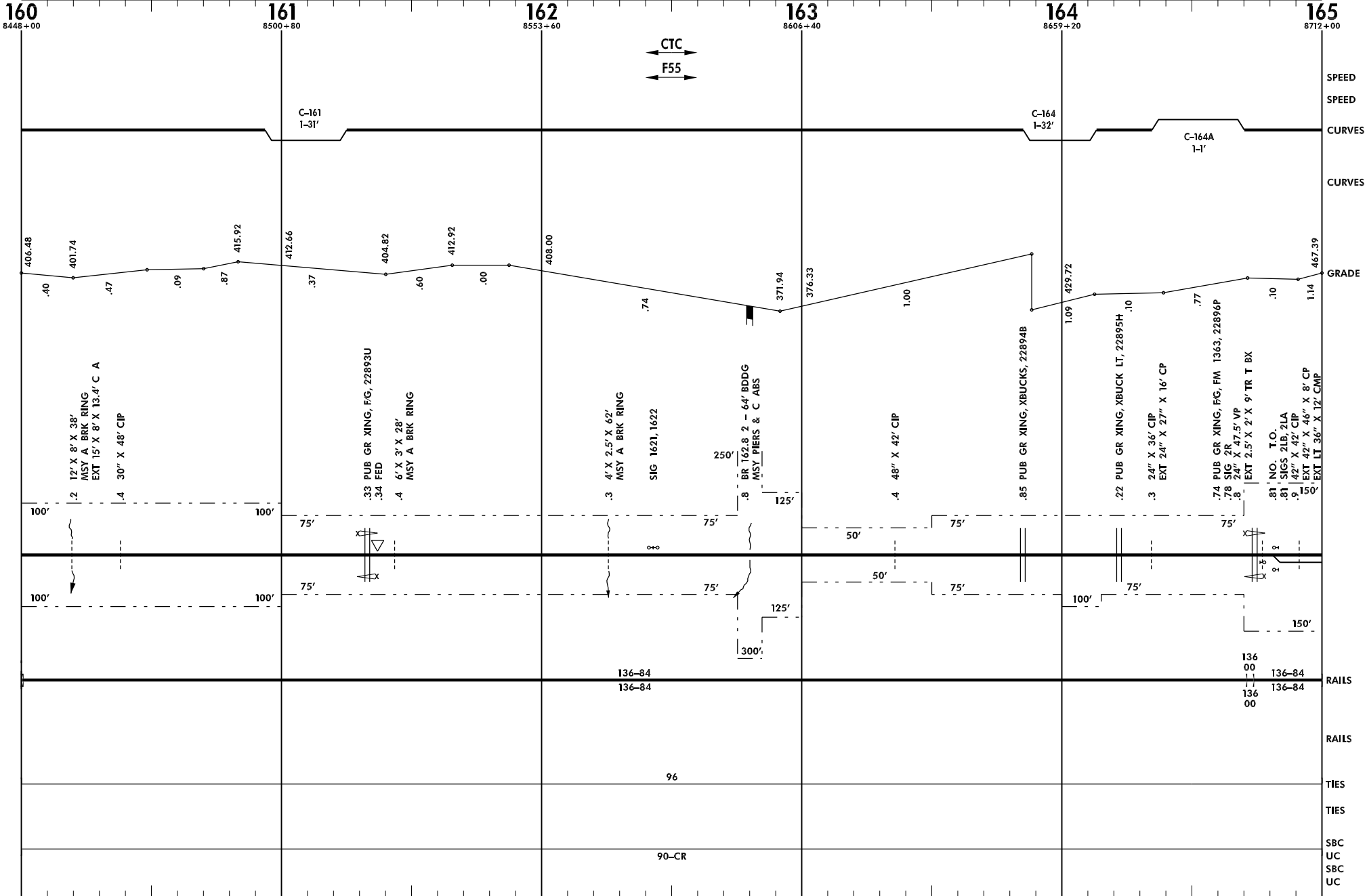

← Galveston, TX

Line Segment 7500

Temple, TX →

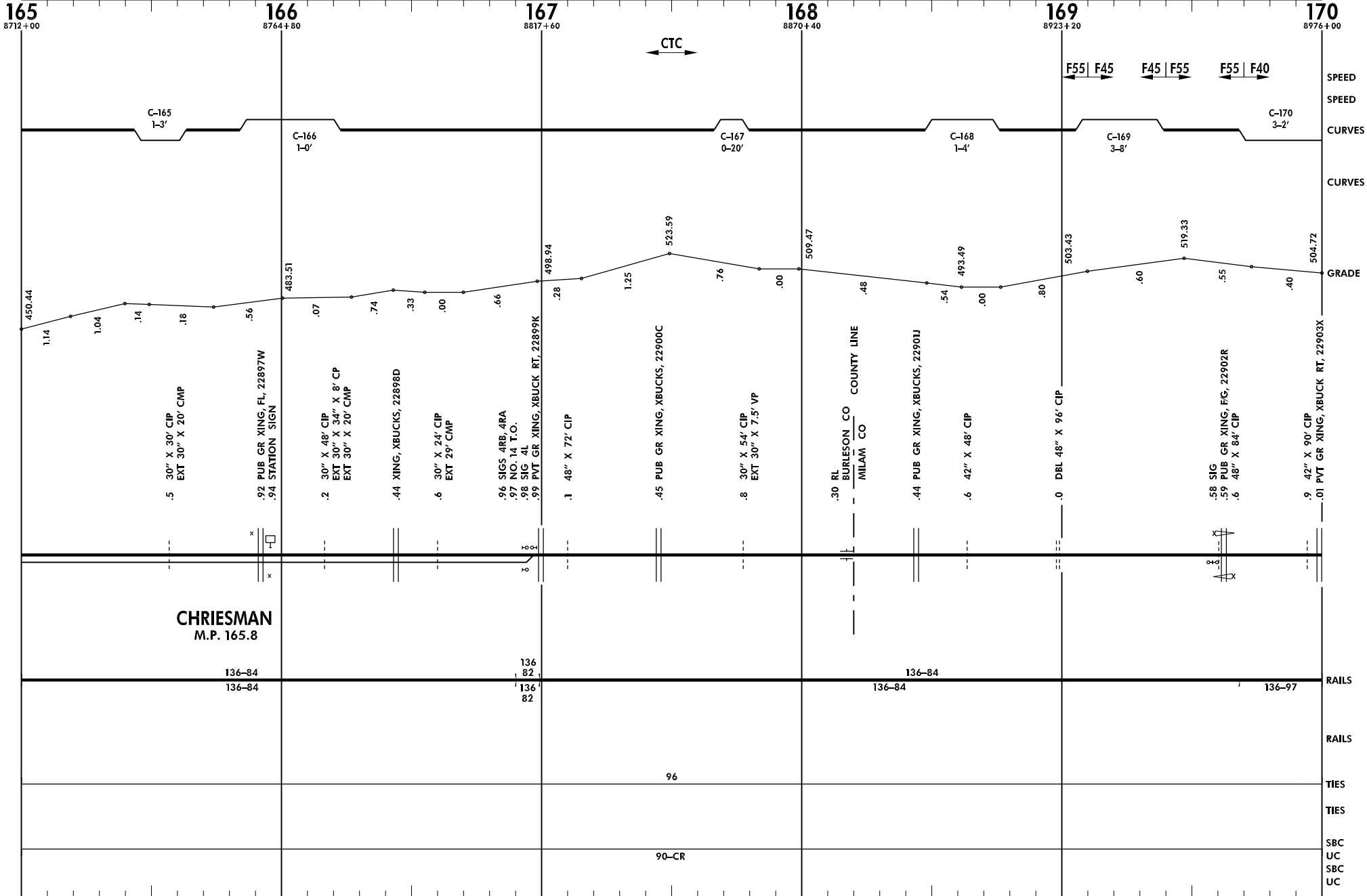

← Galveston, TX

Line Segment 7500

Temple, TX →

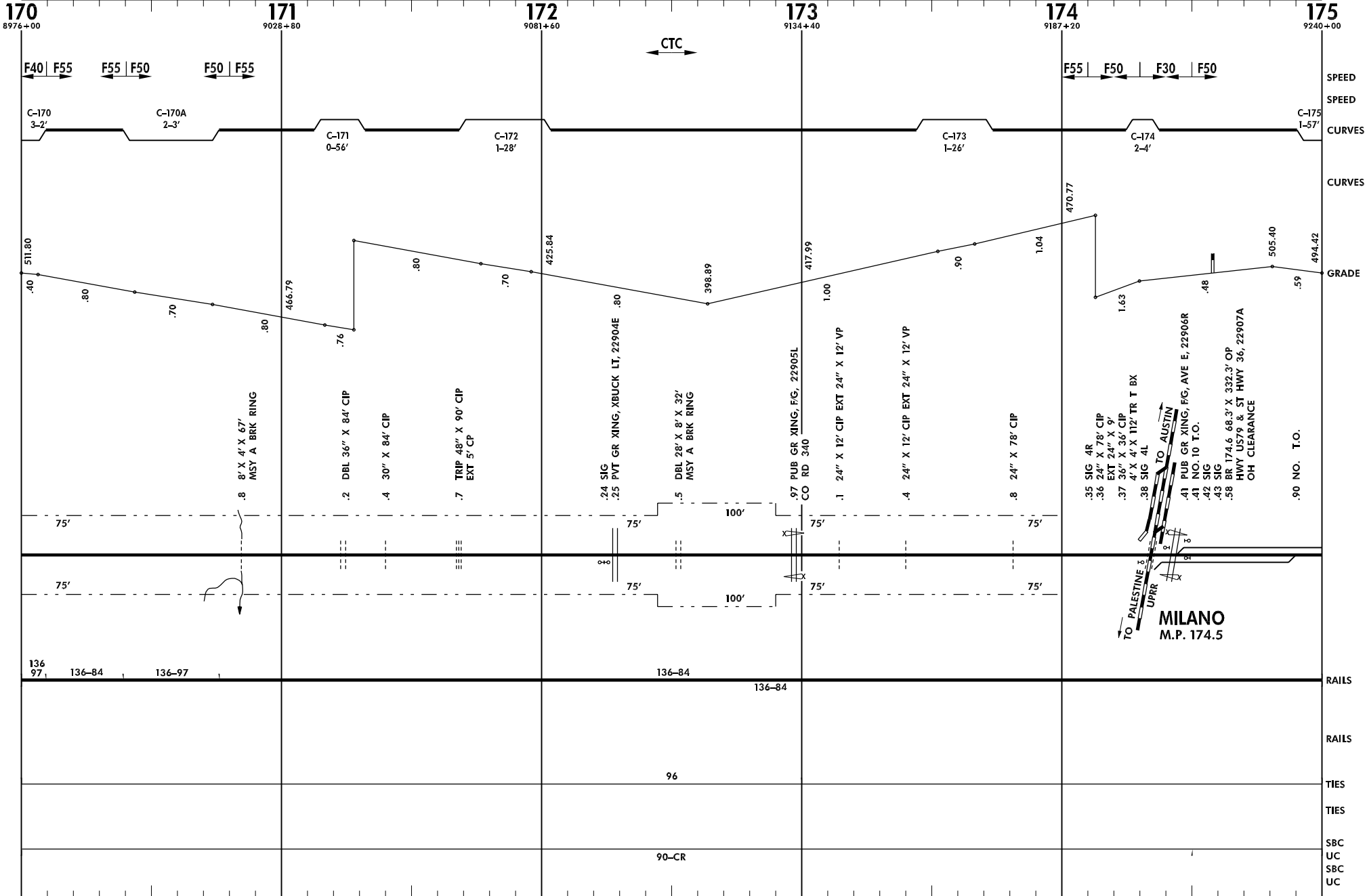

← Galveston, TX

Line Segment 7500

Temple, TX →

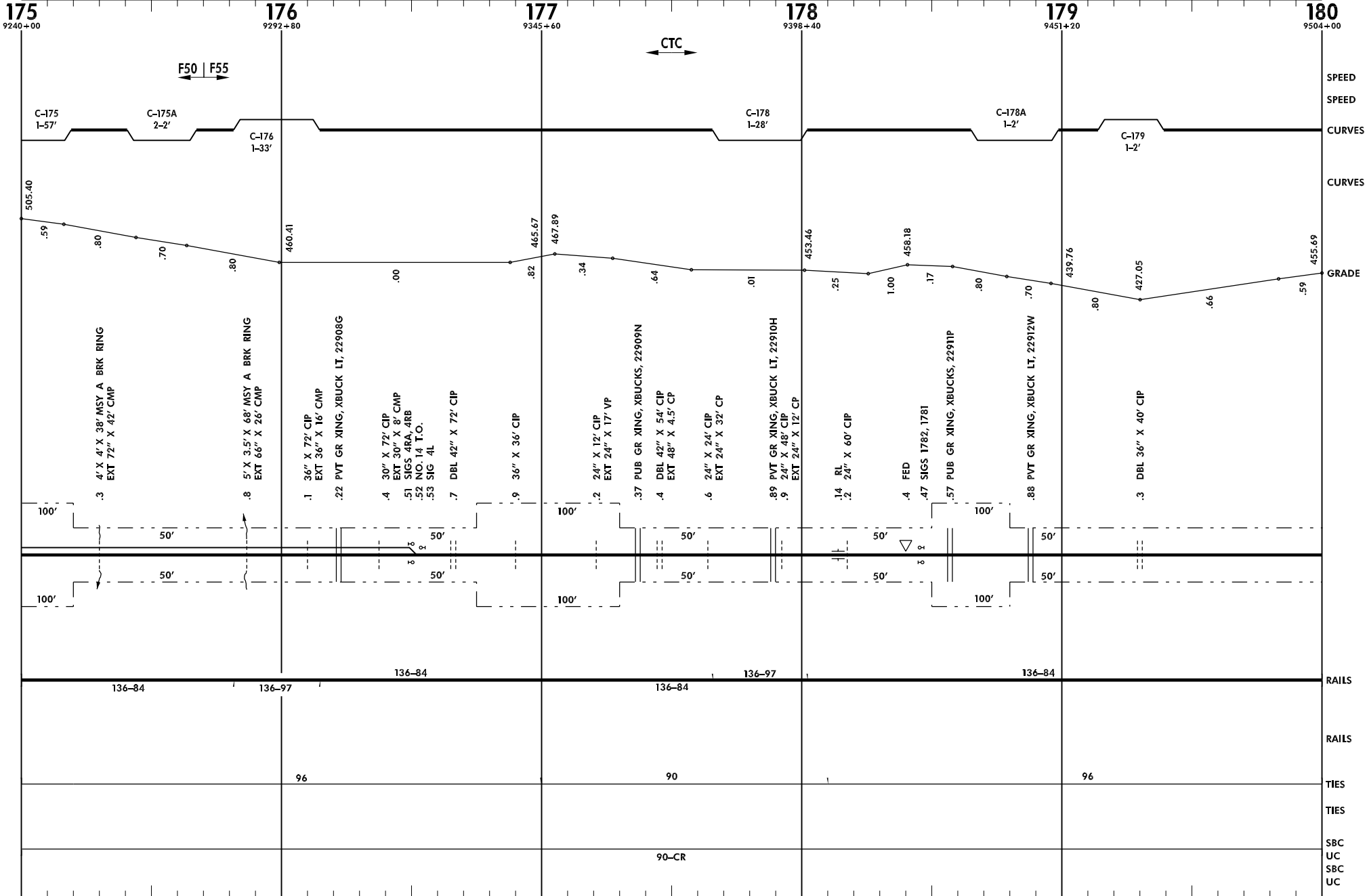

← Galveston, TX

Line Segment 7500

Temple, TX →

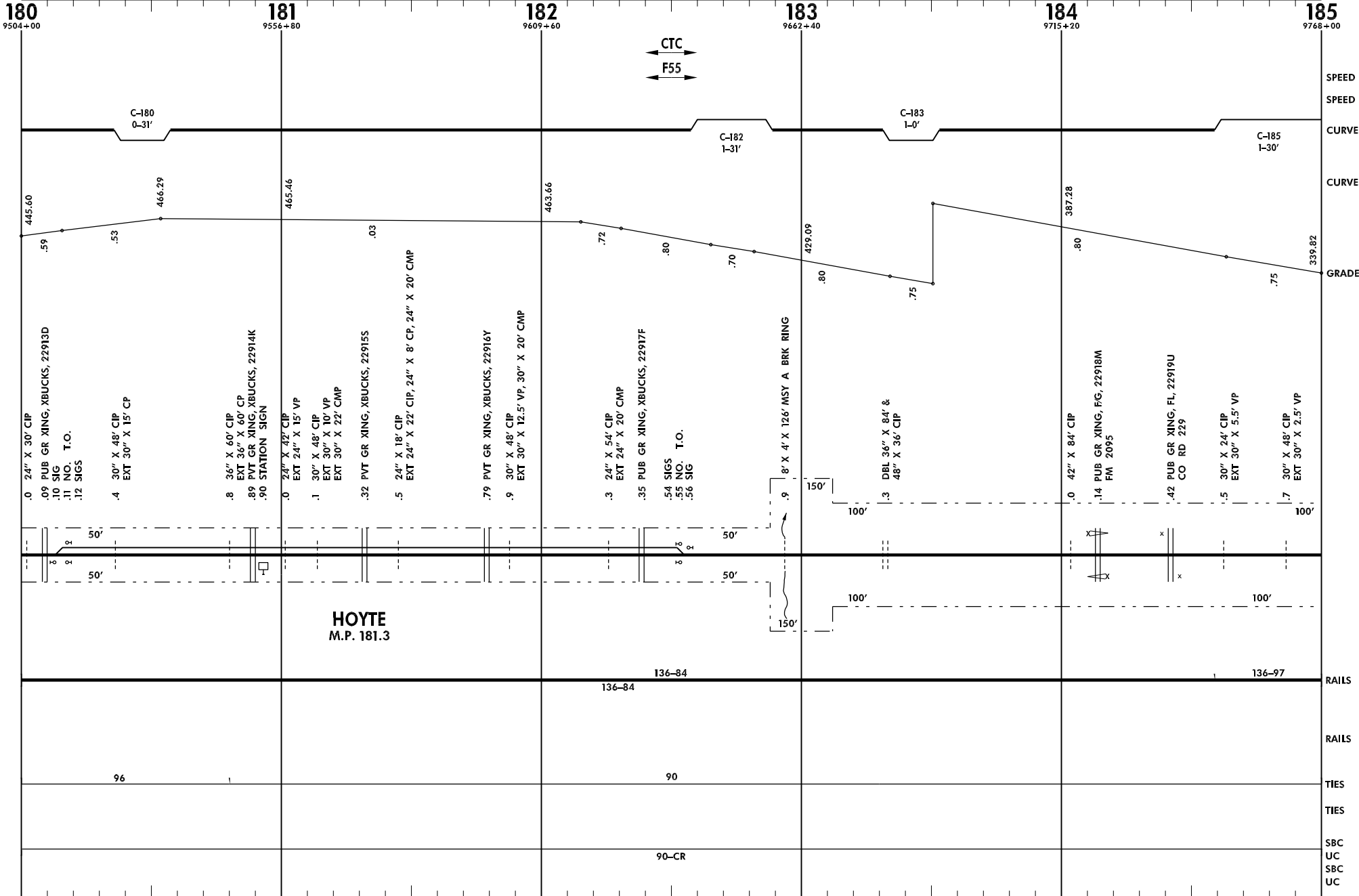

Burlington Northern and Santa Fe Railway Company

GAL037.DGN

Revised: 11/20/1998

Galveston Subdivision

← Galveston, TX

Line Segment 7500

→ Temple, TX

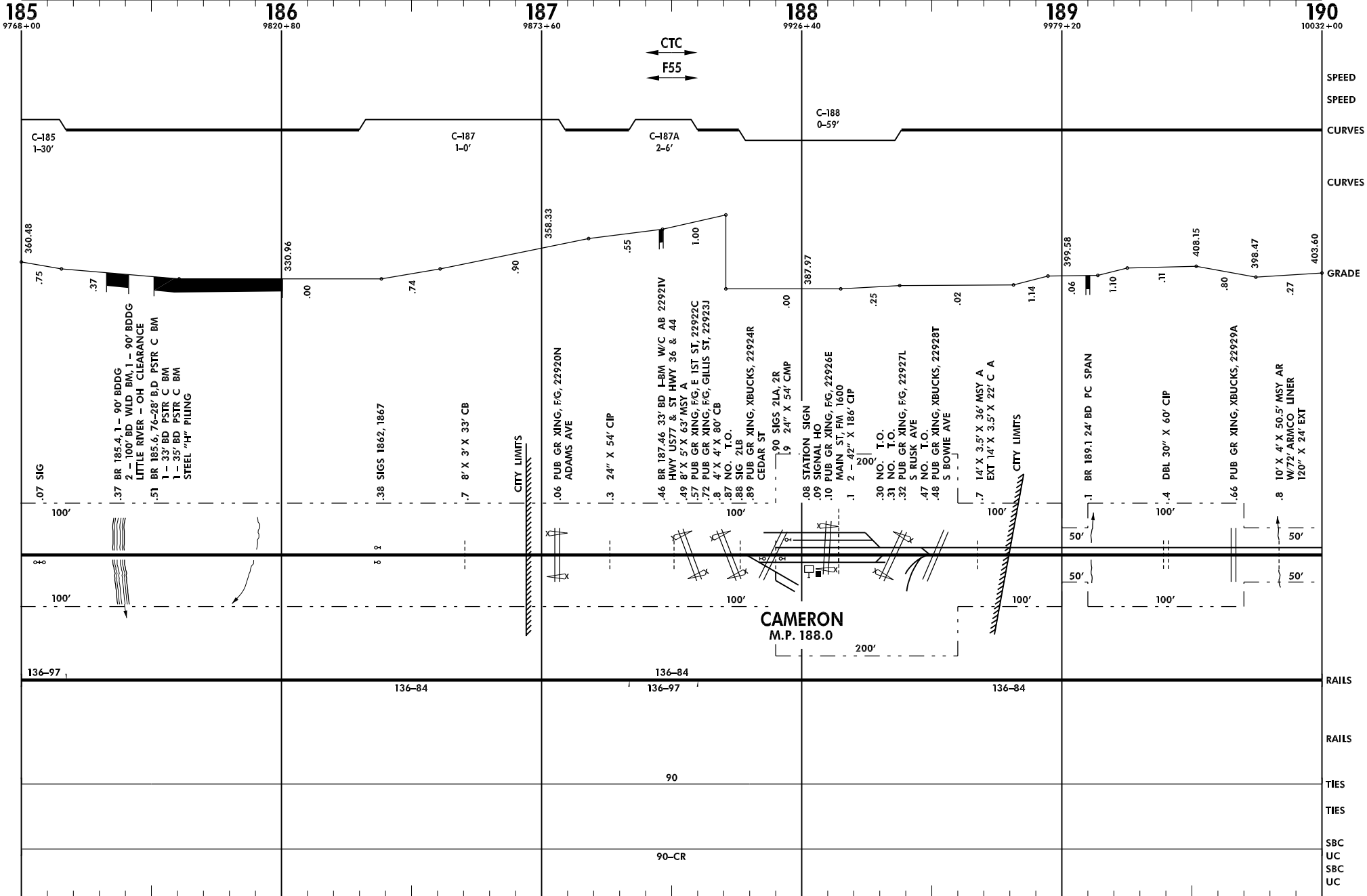

← Temple, TX

Line Segment 7500

Galveston, TX →

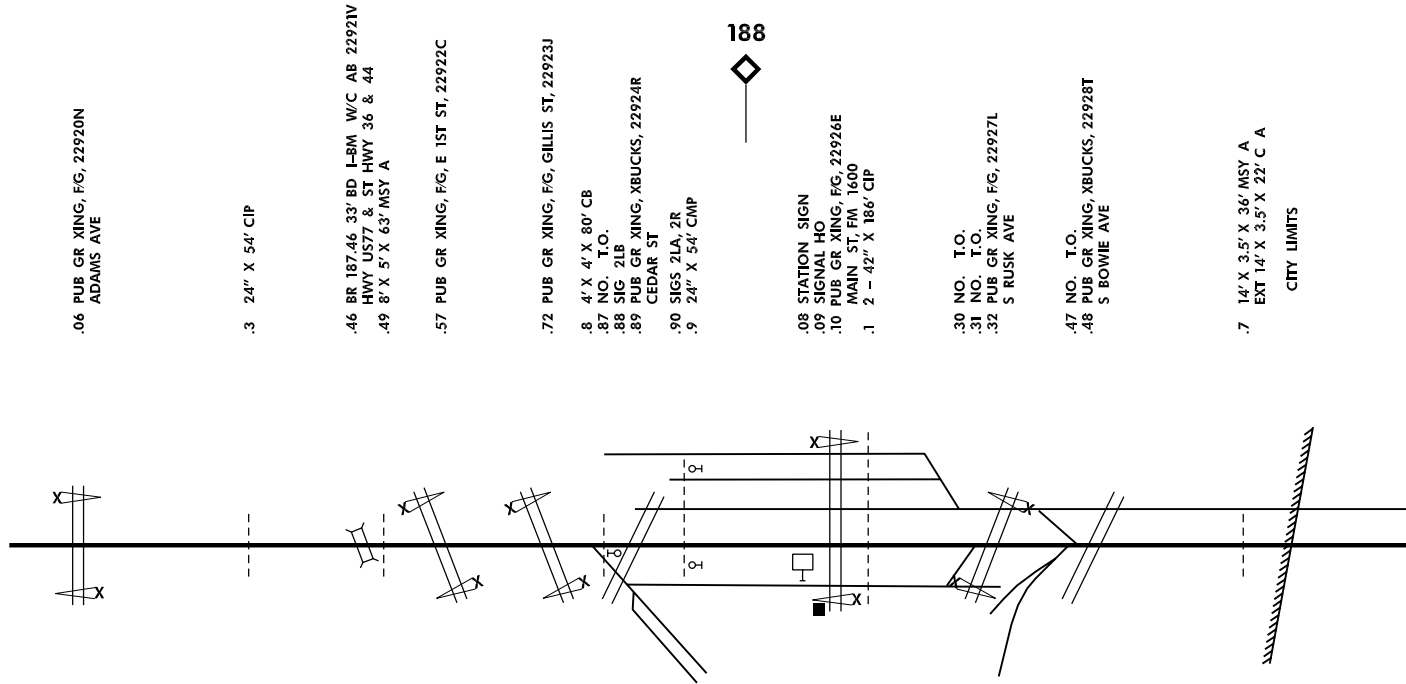

.06 PUB GR XING, F/G, 22920N
ADAMS AVE

.3 24" X 54' CIP

.46 BR 187.46 33' BD L-EM W/C AB 22921V
HWY US77 & 5T HWY 36 & 44
.49 8' X 5' X 63' MSY A

.57 PUB GR XING, F/G, E 1ST ST, 22922C

.72 PUB GR XING, F/G, GILLIS ST, 22923J

.8 4' X 4' X 80' CB
.87 NO. T.O.

.88 SIG 2LB
.89 PUB GR XING, XBUCKS, 22924R
CEDAR ST

.90 SIGS 2LA, 2R
.9 24" X 54' CMP

188



.08 STATION SIGN
.09 SIGNAL HO
.10 PUB GR XING, F/G, 22926E
MAIN ST, FM 1600
.1 2 - 42" X 186' CIP

.30 NO. T.O.
.31 NO. T.O.
.32 PUB GR XING, F/G, 22927L
S RUSK AVE

.47 NO. T.O.
.48 PUB GR XING, XBUCKS, 22928T
S BOWIE AVE

.7 14' X 3.5' X 36' MSY A
EXT 14' X 3.5' X 22' C A
CITY LIMITS

CAMERON, TX
M.P. 188.0
TRACK SCHEMATIC
(NOT TO SCALE)

← Galveston, TX

Line Segment 7500

→ Temple, TX

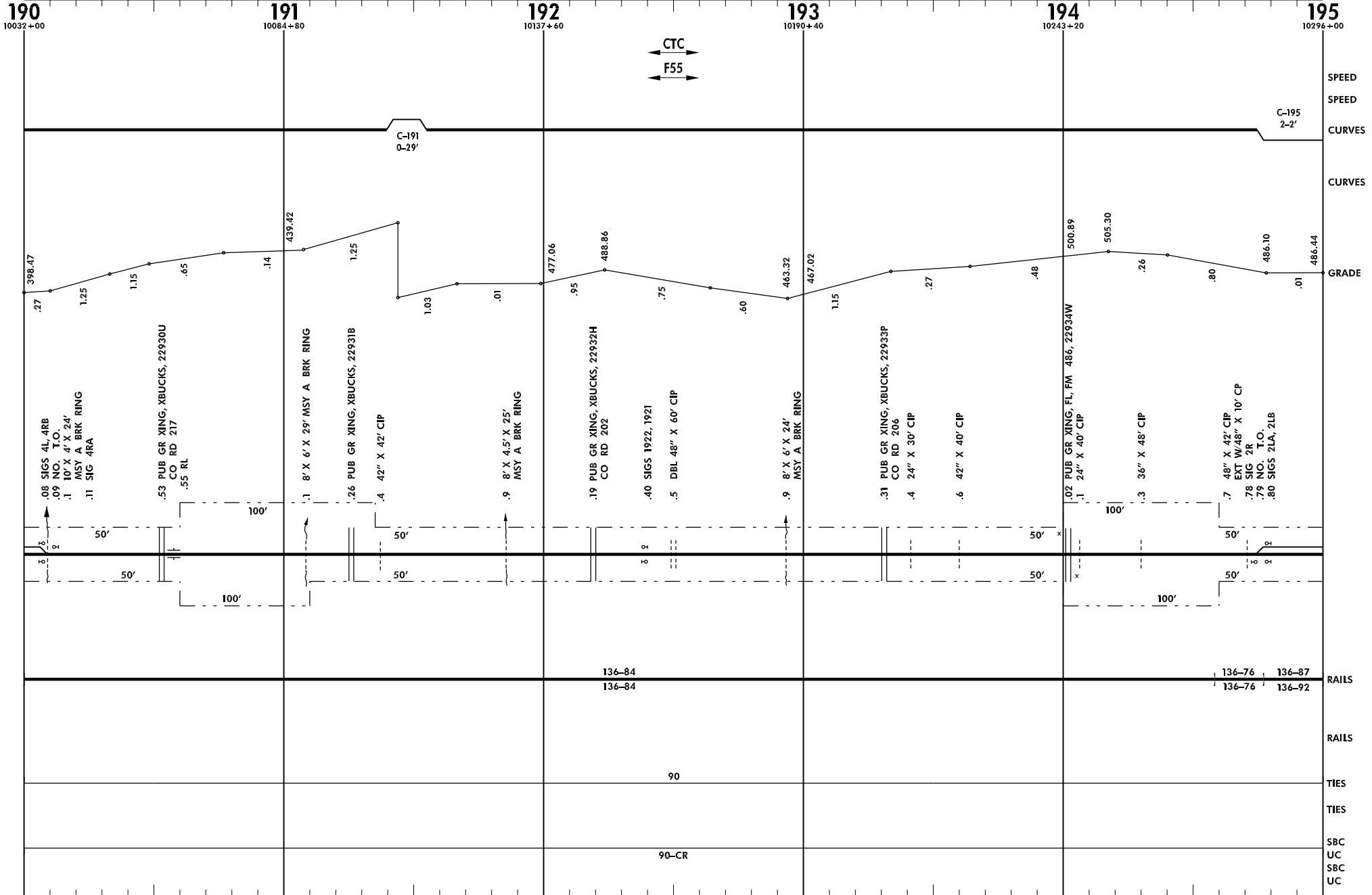

Burlington Northern and Santa Fe Railway Company

GAL039.DGN

Revised: 11/20/1998

Galveston Subdivision

← Galveston, TX

Line Segment 7500

Temple, TX →

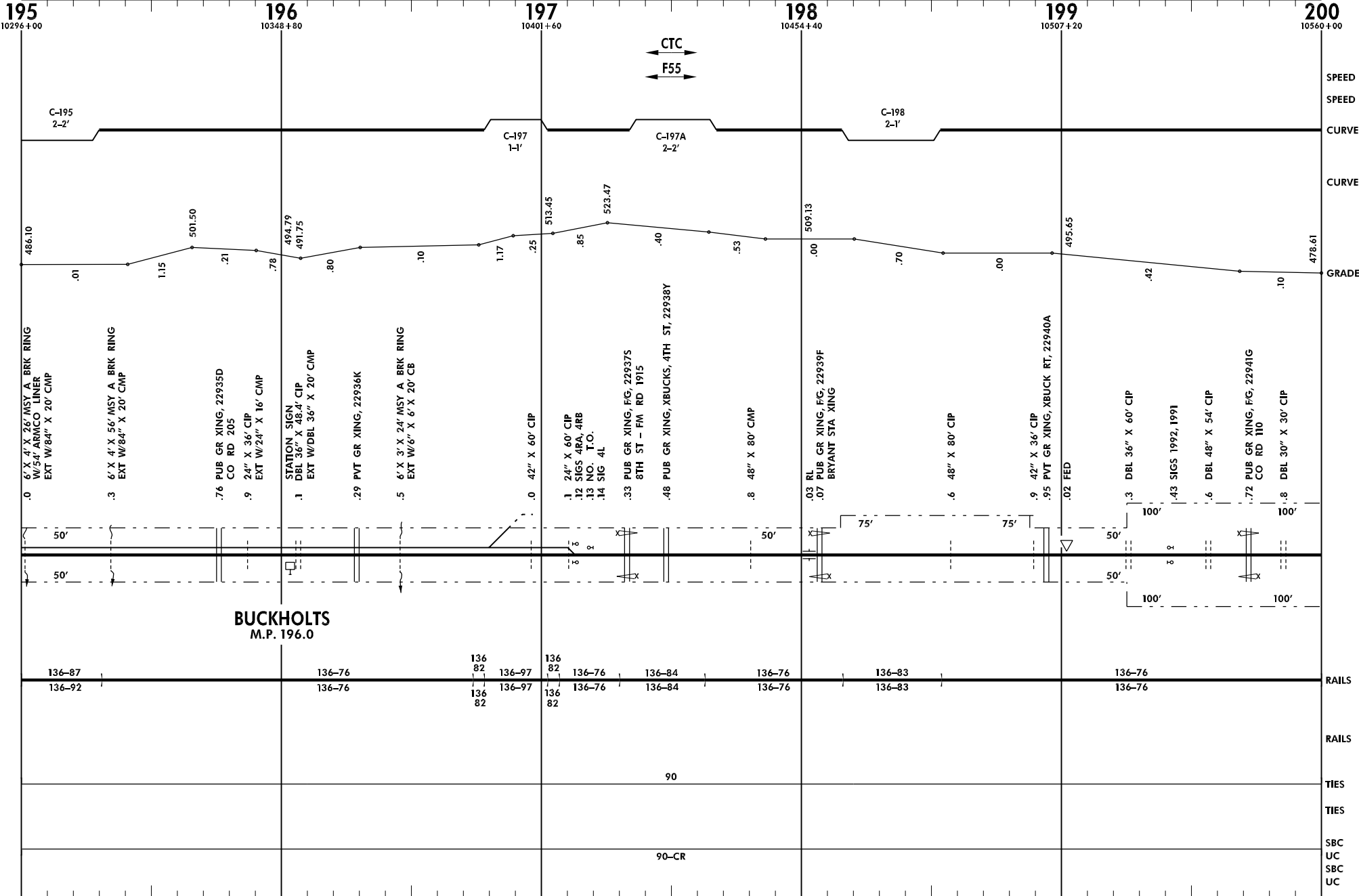

← Galveston, TX

Line Segment 7500

→ Temple, TX

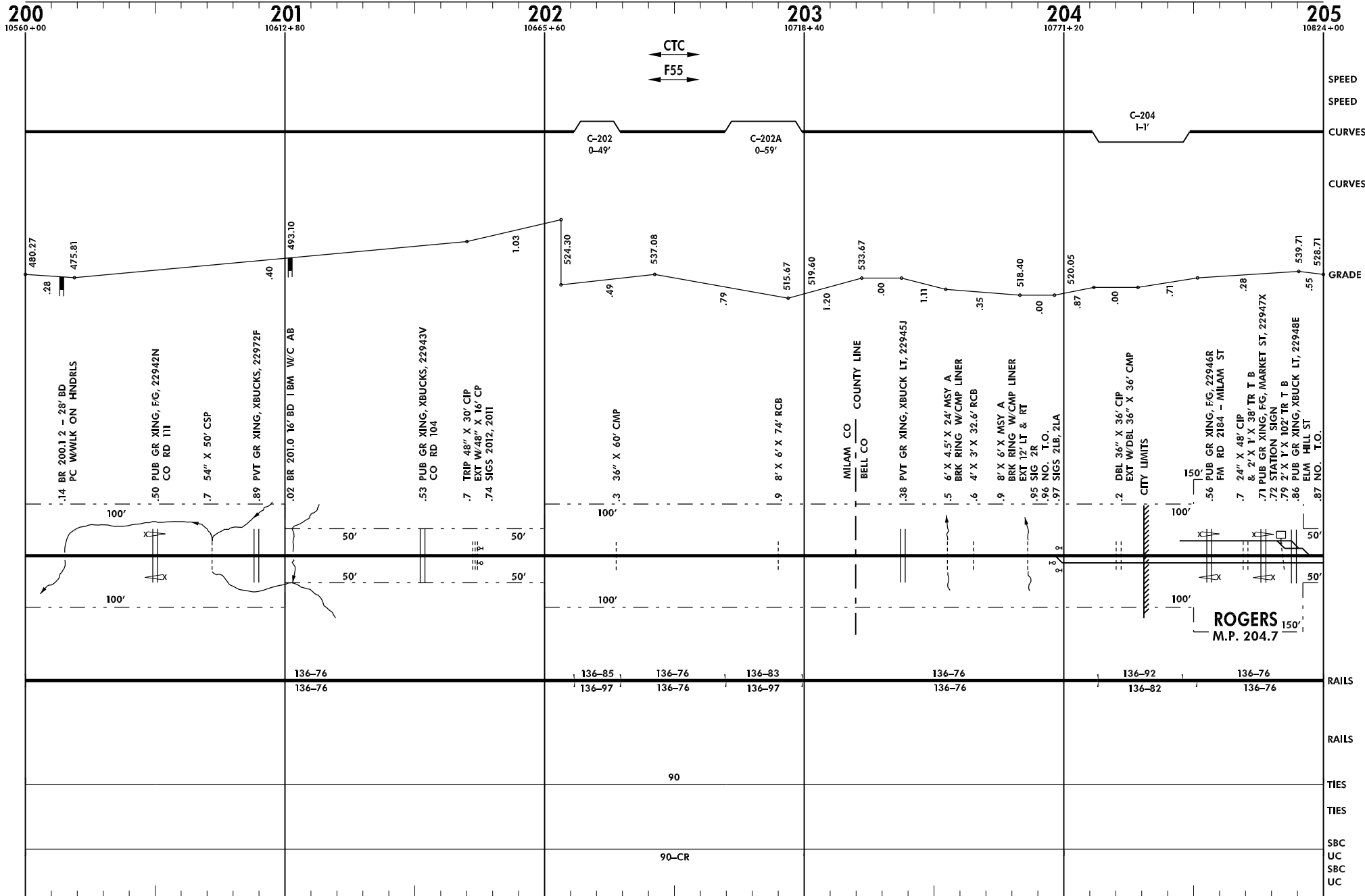

← Galveston, TX

Line Segment 7500

→ Temple, TX

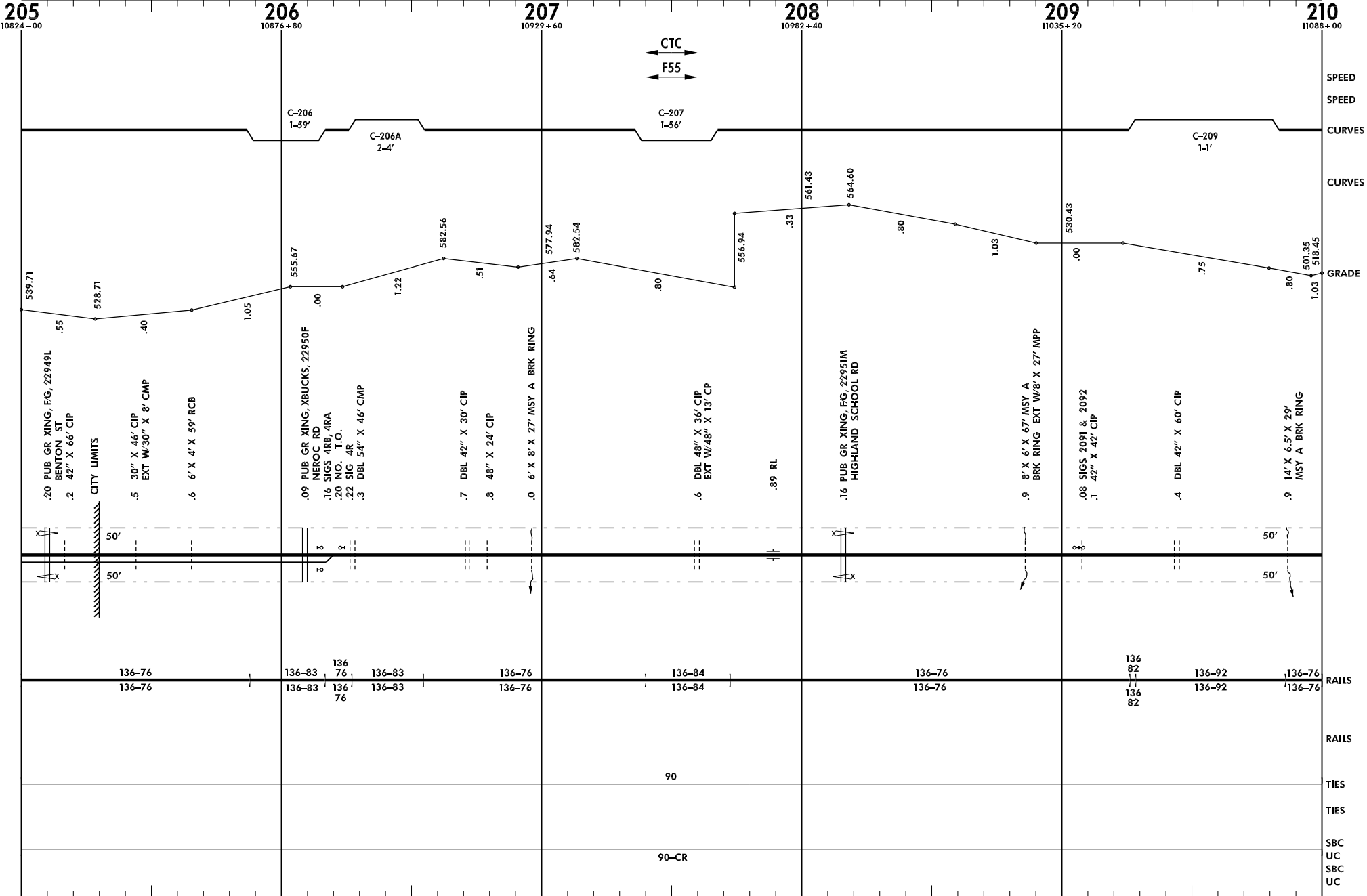

← Galveston, TX

Line Segment 7500

→ Temple, TX

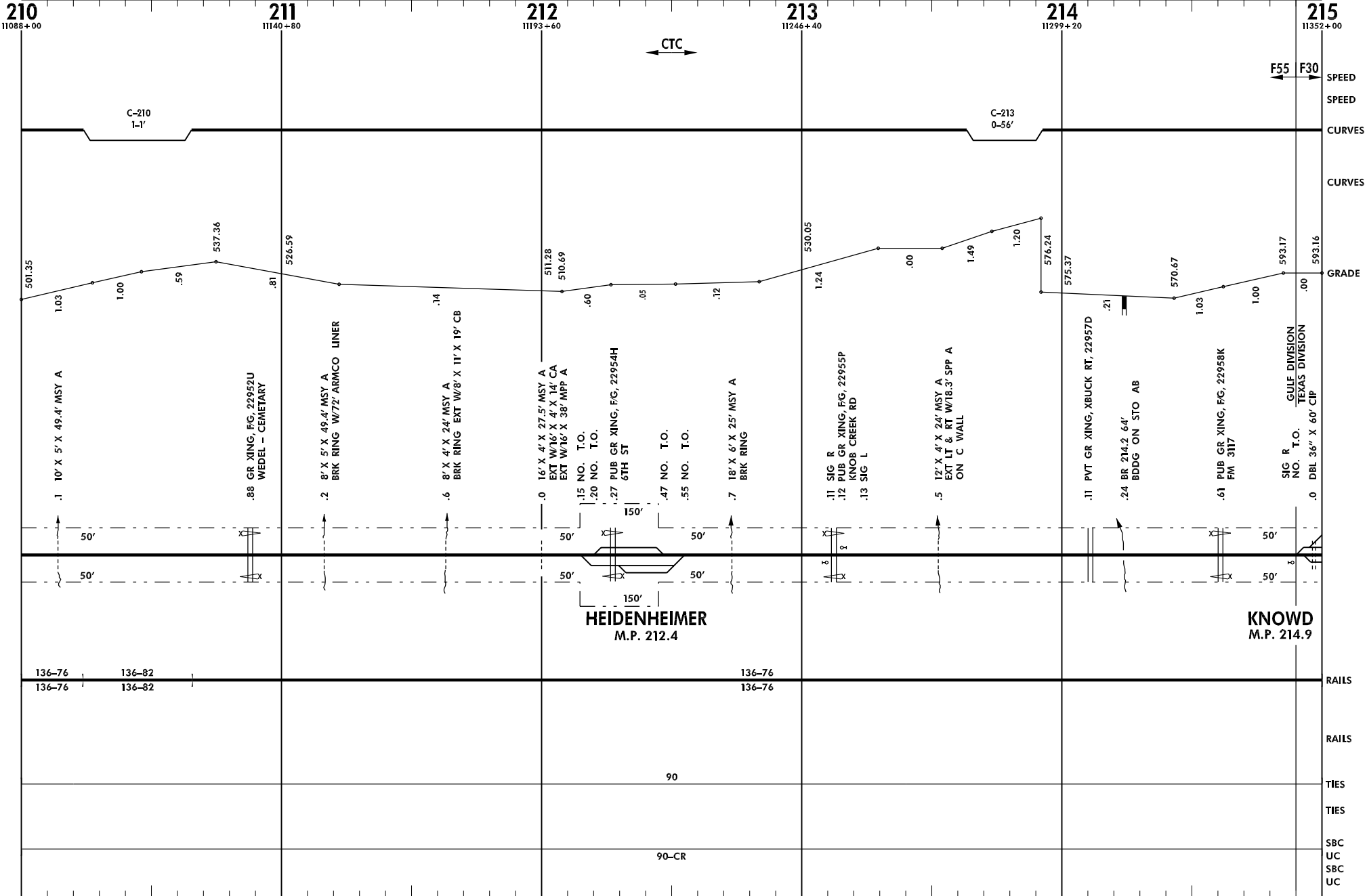

Burlington Northern and Santa Fe Railway Company

GAL043.DGN

Revised: 11/20/1998

Galveston Subdivision

← Galveston, TX

Line Segment 7500

Gainesville, TX →

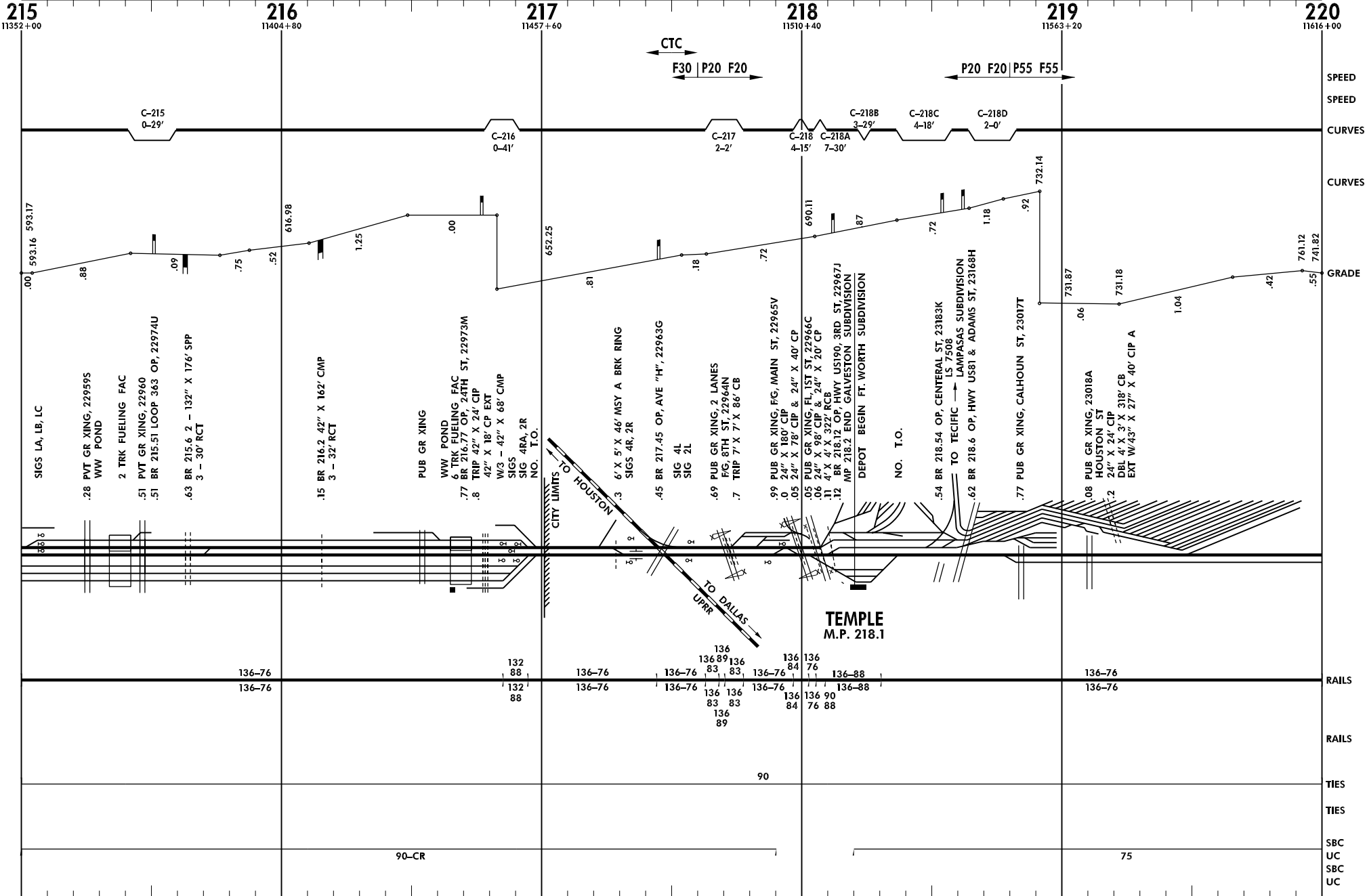

← Temple, TX

Line Segment 7500

Galveston, TX →

TEMPLE, TX
M.P. 218.2
TRACK SCHEMATIC
(NOT TO SCALE)

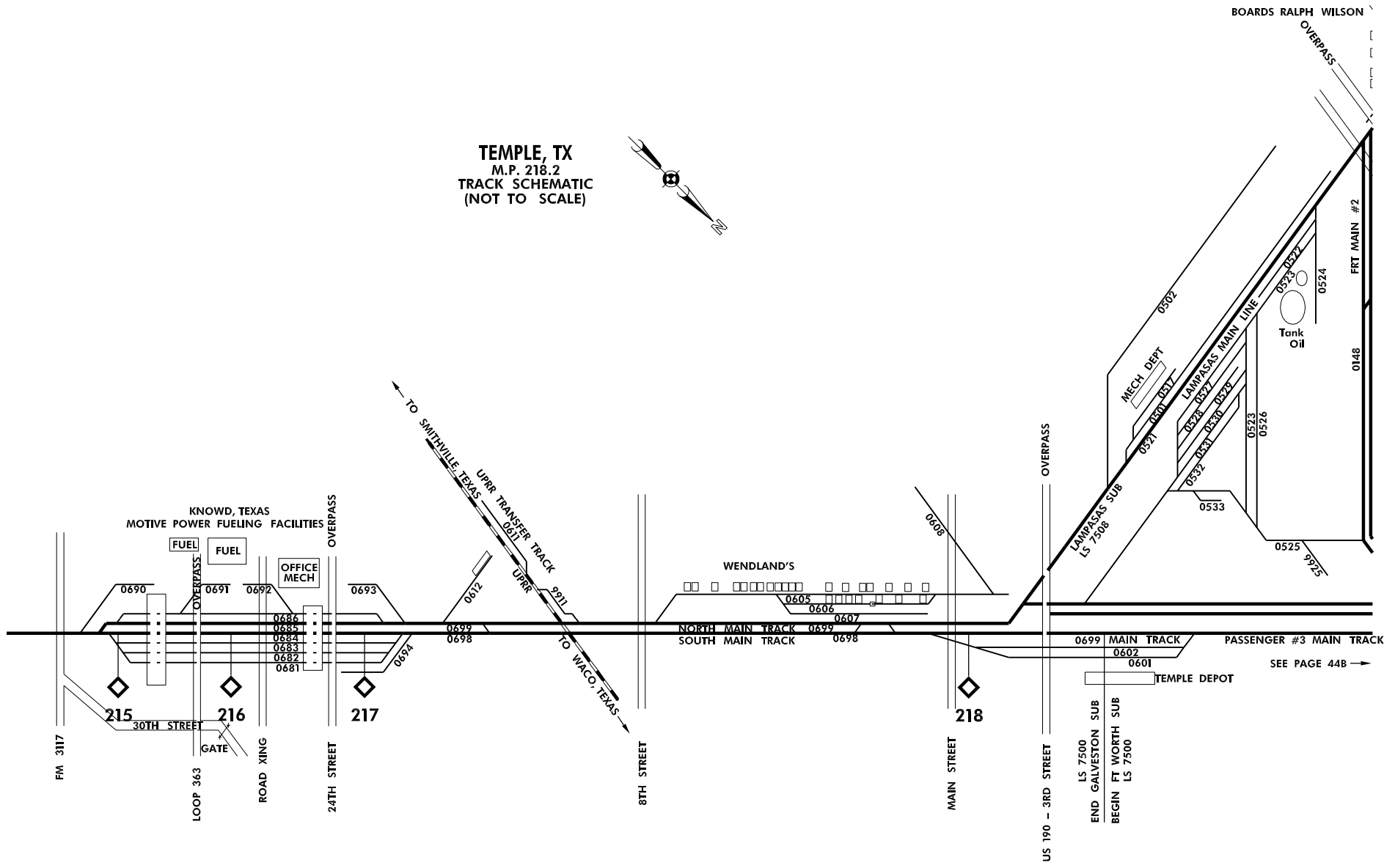
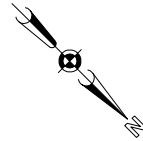

← Temple, TX

Line Segment 7500

Galveston, TX →

