

THE  
CONSOLIDATED CODE  
OF  
TRANSPORTATION RULES  
AND  
GENERAL INSTRUCTIONS

EDITION OF 1939

13883  
No. T. 15142

Joint Form 1

This book is the property of the

**CHICAGO, MILWAUKEE, ST. PAUL AND  
PACIFIC RAILROAD COMPANY**

It is loaned to

Name	Occupation
Evelyn Elford	Fireman.
2932 W. Chicago Ave.	
Chicago, Ill.	

who hereby agrees to return it to the proper officer when called for, or upon leaving the service.

150

The rules herein set forth govern the railroads operated as listed below. They take effect April 1, 1939, superseding all previous rules and instructions inconsistent therewith.

Special instructions may be issued by proper authority.

**CHICAGO, MILWAUKEE, ST. PAUL AND PACIFIC  
RAILROAD COMPANY**

Henry A. Scandrett, Walter J. Cummings, George I. Haight,  
*Trustees.*

J. T. Gillick, *Chief Operating Officer.*

**GREAT NORTHERN RAILWAY COMPANY  
AND AFFILIATED LINES**

C. O. Jenks, *Vice President.*

**NORTHERN PACIFIC RAILWAY COMPANY  
AND AFFILIATED LINES**

H. E. Stevens, *Vice President.*

**SPOKANE, PORTLAND AND SEATTLE RAILWAY  
COMPANY AND AFFILIATED LINES**

W. C. Sloan,  
*General Manager.*

R. A. McCandless,  
*General Manager.*

**UNION PACIFIC RAILROAD, NORTHWESTERN  
DISTRICT**

H. C. Mann, *Vice President.*

### GENERAL NOTICE.

Safety is of the first importance in the discharge of duty.

Obedience to the rules is essential to safety.

To enter or remain in the service is an assurance of willingness to obey the rules.

The service demands the faithful, intelligent and courteous discharge of duty.

To obtain promotion, ability must be shown for greater responsibility.

### GENERAL RULES.

A. Employes whose duties are prescribed by these rules must provide themselves with a copy.

Employes whose duties are in any way affected by the time-table must have a copy of the current time-table with them while on duty.

B. Employes must be conversant with and obey the rules and special instructions. If in doubt as to their meaning they must apply to proper authority for an explanation.

C. Employes must pass the required examinations.

D. Persons employed in any service on trains are subject to the rules and special instructions.

E. Employes must render every assistance in their power in carrying out the rules and special instructions and must report to the proper officer any violation thereof.

F. Accidents, failure in the supply of water or fuel, defects in track, bridges, signals, or any unusual conditions which may affect the movement of trains, must be promptly reported by wire to the proper authority.

G. The use of intoxicants or narcotics is prohibited.

H. The use of tobacco by employes on duty in or about passenger stations, or on passenger cars, is prohibited.

J. Employes on duty must wear the prescribed badge and uniform and be neat in appearance.

K. To avoid annoyance to the public, employes and others authorized to transact business at stations and on or about trains, must be courteous, orderly and quiet.

L. In case of danger to the Company's property employes must unite to protect it.

M. Employes must exercise care to prevent injury to themselves or others by observing the condition of equipment and the tools which they use in performing their duties and when found defective will, if prac-

ticable, put them in safe condition, reporting defects to the proper authority.

They must inform themselves as to the location of structures or obstructions where clearances are close.

They must expect trains to run at any time, on any track, in either direction.

They must not stand on the track in front of an approaching engine or car for the purpose of boarding the same.

### DEFINITIONS.

**Engine.**—A locomotive propelled by any form of energy and used in train or yard service.

**Motor Car.**—A car propelled by any form of energy and used in train or yard service.

**Note.**—Where the term "engine" appears in these rules, it applies to either "Engine" or "Motor Car."

**Train.**—An engine or motor car or more than one engine or motor car coupled, with or without cars, displaying markers.

**Regular Train.**—A train authorized by a time-table schedule.

**Section.**—One of two or more trains running on the same schedule displaying signals or for which signals are displayed.

**Extra Train.**—A train not authorized by a time-table schedule. It may be designated as—

Extra—for any extra train except passenger extra or work extra;

Passenger extra—for passenger train extra;

Work extra—for work train extra.

**Superior Train.**—A train having precedence over another train.

**Train of Superior Right.**—A train given precedence by train order.

**Train of Superior Class.**—A train given precedence by time-table.

**Train of Superior Direction.**—A train given precedence in the direction specified by time-table as between opposing trains of the same class.

**Time-Table.**—The authority for the movement of regular trains subject to the rules. It contains the classified schedules of trains with special instructions relating to the movement of trains.

**Schedule.**—That part of a time-table which prescribes class, direction, number and movement for a regular train.

**Division.**—That portion of a railroad assigned to the supervision of a superintendent.

**Subdivision.**—A portion of a division designated by time-table.

**Main Track.**—A track extending through yards and between stations, upon which trains are operated by time-table or train order, or both, or the use of which is governed by block signals.

**Single Track.**—A main track upon which trains are operated in both directions.

**Two or More Tracks.**—Two or more main tracks upon any of which the current of traffic may be in either specified direction.

**Current of Traffic.**—The movement of trains on a main track, in one direction, specified by the rules.

**Station.**—A place designated on the time-table by name.

**Siding.**—A track auxiliary to the main track for meeting or passing trains.

**Fixed Signal.**—A signal of fixed location indicating a condition affecting the movement of a train or engine.

**Note.**—The definition of a "Fixed Signal" covers such signals as switch, train order, block, interlocking, semaphore, disc, ball, stop boards, yard limit boards, slow boards, or other means for displaying indications that govern the movement of a train, or engine.

**Yard.**—A system of tracks within defined limits provided for the making up of trains, storing of cars and other purposes, over which movements not authorized by time-table, or by train order, may be made, subject to prescribed signals and rules, or special instructions.

**Yard Engine.**—An engine assigned to yard service and working within yard limits.

**Pilot.**—An employe assigned to a train when the engineman or conductor, or both, are not fully acquainted with the physical characteristics or rules of the railroad, or portion of the railroad, over which the train is to be moved.

**Train Register.**—A book or form which may be used at designated stations for registering signals displayed, the time of arrival and departure of trains and such other information as may be prescribed.

**Bulletin.**—Advice of conditions affecting the movement or safety of trains.

**Restricted Speed.**—Proceed prepared to stop short of train, obstruction, or anything that may require the speed of a train to be reduced.

In the illustrations of signal aspects,

R=Red

Y=Yellow

G=Green

### OPERATING RULES.

Note.—Rules with a prefix "S" are for single track; those with a prefix "D" are for two or more tracks. Rules without a prefix are for single and two or more tracks. The prefixes "S" and "D" to be printed in italics.

### STANDARD TIME.

1. Standard Time obtained from an authorized observatory will be transmitted to all points from designated offices at 11 a. m. Central Time, 10 a. m. Mountain Time, 9 a. m. Pacific Time, daily.

2. Watches that have been examined and certified to by a designated inspector must be used by train dispatchers, conductors, enginemen, brakemen, switchmen, flagmen, firemen, yardmasters, foremen of yard engines, outside hostlers, main track switch tenders, and pilots or engine herders and such other employes as may be designated. The certificate in prescribed form must be renewed and filed with the watch inspector every six months.

(Form of Certificate.)

### CERTIFICATE OF WATCH INSPECTOR

This is to certify that on....., 19.....  
the watch of .....  
employed as .....  
on the .....R....., was  
examined by me. It is correct and reliable, and, with  
proper care, should run within a variation of thirty seconds  
per week.

Name of maker .....

Grade .....

Number of movement .....

Open or hunting case .....

Metal of case .....

Signed, .....

Inspector.

Address .....

2 (A). Watches subject to inspection must be presented at semi-monthly intervals, to a designated inspector for comparison and registration on prescribed form.

3. Unless otherwise provided, the watches of train dispatchers, conductors, enginemen, yardmasters and foremen of yard engines must be compared with a standard clock before commencing each day's work. The time when watches are compared must be registered on a prescribed form. The location of standard clocks will be shown in the time-table.

3 (A). Conductors, enginemen, yardmasters and foremen of yard engines who do not have access to a standard clock must compare their watches daily with each other and with conductors and enginemen who have standard time and have registered, or with the train dispatcher and make a record of such comparison on the back of the time slip showing time, place, and with whom comparison was made.

At the first opportunity, other employes of the crew must compare with the conductor or engineman. Employes must assure themselves watches are wound, and when practicable, the conductor or foreman of yard engine should contact the engineman and compare time before starting the trip or day's work.

#### TIME-TABLES.

4. Each time-table, from the moment it takes effect, supersedes the preceding time-table, and its schedules take effect on any division, or subdivision, at the leaving time at their initial stations on such division, or subdivision. But when a schedule of the preceding time-table corresponds in number, class, day of leaving, direction, and initial and terminal stations with a schedule of the new time-table, a train authorized by the preceding time-table will retain its train orders and assume the schedule of the corresponding number of the new time-table.

Schedules on each division, or subdivision, date from their initial stations on such division, or subdivision.

Not more than one schedule of the same number and day shall be in effect on any division, or subdivision.

Note.—Where there are subdivisions, schedules date from the initial station of the subdivision. Day of leaving under this rule means the day of the week that the schedule authorizes a train to leave its initial station.

4 (A). Notice of new time-tables will be bulletined.

During a period commencing 24 hours before and continuing until six days after a new time-table takes effect, notice by train order form T will be issued to conductors, enginemen, yardmasters and yard engines.

5. Not more than two times are given for a train at any station; where one is given, it is, unless otherwise indicated, the leaving time; where two, they are the arriving and the leaving time.

Unless otherwise provided, the time applies at the switch where an opposing train enters the siding; where there is no siding, it applies to the place from which fixed signals are operated; where there is neither siding nor fixed signal, it applies to the place where traffic is received or discharged.

Schedule meeting or passing stations are indicated by figures in full-faced type.

Both the arriving and leaving time of a train are in full-faced type when both are meeting or passing times, or when one or more trains are to meet or pass it between those times.

Where there are one or more trains to meet or pass a train at any station, attention is called to it by the numbers of the trains to be met or passed in small figures, adjoining.

When trains are to be met or passed at a siding extending between two adjoining stations, the time at each end of the siding will be shown in full-faced type.

6. The following letters, when placed before the figures of the schedule, indicate:

- L.—leave;
- A.—arrive;
- s.—regular stop;
- f.—flag stop to receive or discharge traffic.

6 (A). The following letters, when placed in the columns provided, indicate:

- B—bulletins;
- C—coal;

D—day operator;  
 DN—day and night operator;  
 E—refreshments;  
 H—hog drenching;  
 I—interlocking;  
 J—junction;  
 K—standard clock;  
 M—railroad crossing protected by signals or gates;  
 N—night operator;  
 O—oil;  
 P—telephone;  
 R—train register;  
 T—turntable;  
 V—track connection with foreign road;  
 W—water;  
 X—yard limits;  
 Y—wye;  
 Z—track scales.

#### SIGNALS.

7. Employes whose duties may require them to give signals, must provide themselves with the proper appliances, keep them in good order and ready for immediate use.

7 (A). Signals must be used strictly in accordance with the rules, and trainmen, yardmen, engine men, and all concerned must keep a constant lookout for them. Those giving signals must locate themselves so as to be plainly seen, and give them so as to be plainly understood. The utmost care must be exercised by trainmen, yardmen and engine men to avoid taking signals that may be intended for other trains or engines. Unless trainmen, yardmen and engine men are positive that signals given are for them, they will not move their train until communication is made by words. When backing a train or cars, the disappearance from view, of trainmen or light by which signals are given, must be construed as a stop signal.

8. Flags (either cloth or metal) of the prescribed color must be used by day, and lights of the prescribed color by night.

8 (A) Electric lanterns may be used for displaying white lights only. Their use for displaying colored lights for signaling purposes is not permitted.

9. Day signals must be displayed from sunrise to sunset, but when day signals cannot be plainly seen, night signals must be used in addition.

Night signals must be displayed from sunset to sunrise.

#### COLOR SIGNALS.

Color.	Indication.
(a) Red.	Stop.
(b) Yellow.	Proceed at restricted speed, and for other uses prescribed by the Rules.
(c) Green.	Proceed, and for other uses prescribed by the Rules.
(d) Green and white.	Flag stop. See Rule 28.
(e) Blue.	See Rule 26.
(f) Purple.	When used on derails; stop.

11. A train finding a fusee burning red on or near its track must stop and extinguish the fusee. Train may then proceed at restricted speed.

11 (A). Fusees must not be placed where they might set fire to anything, nor on public road crossings.

#### 12. HAND, FLAG AND LAMP SIGNALS.

Note.—The hand, or a flag, moved the same as the lamp, as illustrated in the following diagrams, gives the same indication, except in the observance of Rule 12 (a) the hand or flag movement may be above the shoulder.

12a.



**STOP.**

Swung across the track.

12b.



**REDUCE SPEED.**

Held horizontally at arm's length.

12c.



**PROCEED.**

Raised and lowered vertically.

12d.



**BACK.**

Swung vertically in a circle at half arm's length across the track.

12f.



**APPLY AIR BRAKES.**

Swung horizontally above the head, when standing.

12g.



**RELEASE AIR BRAKES.**

Held at arm's length above the head, when standing.

12h. Any object waved violently by any one on or near the track is a signal to stop.



#### 14. ENGINE WHISTLE SIGNALS.

Note.—The signals prescribed are illustrated by “o” for short sounds: “—” for longer sounds. The sound of the whistle should be distinct, with intensity and duration proportionate to the distance signal is to be conveyed.

Sound.	Indication.
(a) o	Apply brakes. Stop.
(b) — —	Release brakes. Proceed.
(c) — o o o	Flagman protect rear of train.
(d) — — — —	Flagman may return from west or south, as prescribed by Rule 99.
(e) — — — — —	Flagman may return from east or north, as prescribed by Rule 99.
(f) o o o —	Protect front of train.
(g) o o	Answer to 14 (k) or any signal not otherwise provided for.
(h) o o o	When standing, back. Answer to 12 (d) and 16 (c). When running, answer to 16 (d).
(j) o o o o	Call for signals.
(k) — o o	<b>SINGLE TRACK</b> —To call attention of engine and train crews of trains of the same class, inferior trains and yard engines, and of trains at train order meeting points to signals displayed for a following section. If not answered by a train, the train displaying signals must stop, notify them and ascertain the cause.

Sound.	Indication.
(k) — o o	<b>TWO OR MORE TRACKS</b> —To call attention of engine and train crews of trains of the same class and to inferior trains moving in the same direction and to yard engines to signals displayed for a following section.
(l) — — o —	Approaching public crossings at grade. To be prolonged or repeated until the engine has passed over the crossing.
(m) — — — —	Approaching stations, junctions, railroad crossings at grade, draw bridges, and mail cranes located between stations.
(n) — — o	Approaching meeting or waiting points. Answer to 16 (1). See Rule S-90.
(o) o —	Inspect train line for leak or for brakes sticking.
(p) Succession of short sounds.	Alarm for persons or live stock on the track.
(q) — o	When running against the current of traffic: <ol style="list-style-type: none"> <li>(1) Approaching stations, curves, or other points where view may be obscured.</li> <li>(2) Approaching passenger or freight trains and when passing freight trains.</li> <li>(3) Preceding the signals prescribed by (d) and (e).</li> </ol>

For additional tracks the following signals will be used:

Sound.	Indication.
(r) — — — — — o	Flagman may return from east or north on 3 track or diverging line, as prescribed by Rule 99.
(s) — — — — — o	Flagman may return from west or south on 3 track or diverging line, as prescribed by Rule 99.
(t) — — — — — o o	Flagman may return from east or north on 4 track, as prescribed by Rule 99.
(u) — — — — — o o	Flagman may return from west or south on 4 track, as prescribed by Rule 99.
(v) — — — — — o o o	Flagman may return from east or north on 5 track, as prescribed by Rule 99.
(w) — — — — — o o o	Flagman may return from west or south on 5 track, as prescribed by Rule 99.

15. The explosion of two torpedoes is a signal to proceed at restricted speed. The explosion of one torpedo will indicate the same as two but the use of two is required.

Torpedoes must be placed not less than 100 feet apart and must not be placed at stations, on public crossings, or where they may cause injury.

## 16. COMMUNICATING SIGNALS.

Note.—The signals prescribed are illustrated by "o" for short sounds; "—" for longer sounds.

Sound.	Indication.
(a) o o	When standing—start.
(b) o o	When running—stop at once.
(c) o o o	When standing—back.
(d) o o o	When running—stop at next passenger station.
(e) o o o o	When standing—apply or release air brakes.
(f) o o o o	When running—reduce speed.
(g) o o o o o	When standing—recall flagman.
(h) o o o o o	When running—increase speed.
(j) o o o o o o	When running—increase train heat.
(k) o o o o o o o	Shut off steam heat.
(l) —————	When running—brakes sticking; look back for hand signals; or approaching meeting or waiting points. See Rule S-90.

When practicable, hand signals will be given in addition to 16 (a) and 16 (c). γ

17. The headlight will be displayed to the front of every train by night. It must be concealed or extinguished when a train turns out to meet another and has stopped clear of main track, or is standing to meet a train at end of two or more tracks or a junction.

It must be dimmed while standing on yard tracks where yard engines are employed.

When an engine is running backward, a white light must be displayed by night on the rear of the tender.

Fig. 1.

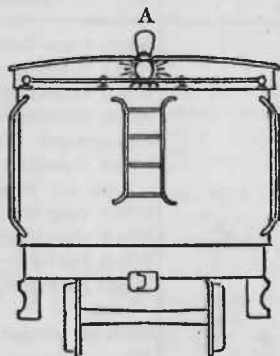

Engine running backward by night, without cars or at the front of a train pulling cars.

White light at A.

17 (A). When the headlight fails enroute, a white light must be used in its place, the bell rung continuously, the whistle sounded frequently, and the train dispatcher notified.

18. Yard engines will display the headlight to the front and rear by night. When not provided with a headlight at the rear, a white light must be displayed.

18 (A). The headlight of engines, on the end that is coupled to cars, may be dimmed or extinguished while so coupled.

19. Unless otherwise provided, the following signals will be displayed to the rear of every train, as markers, to indicate the rear of the train.

Fig. 2.

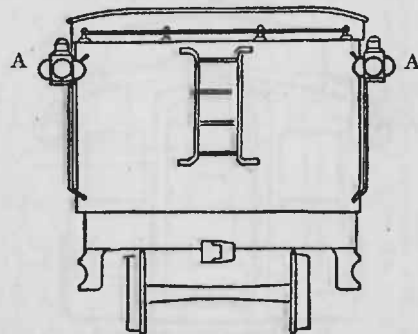

Running forward by day, without cars or at the rear of a train pushing cars.

Marker lamps not lighted, or green flags at A A as markers.

Fig. 3.

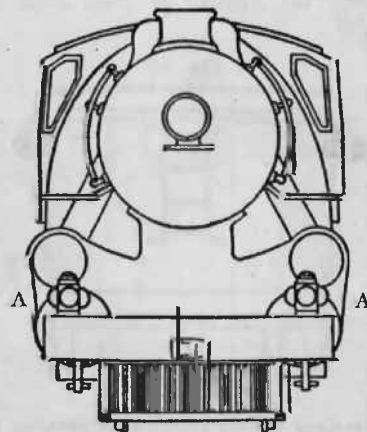

Running backward by day, without cars or at the rear of a train pushing cars.

Marker lamps not lighted, or green flags at A A as markers.

Fig. 4.

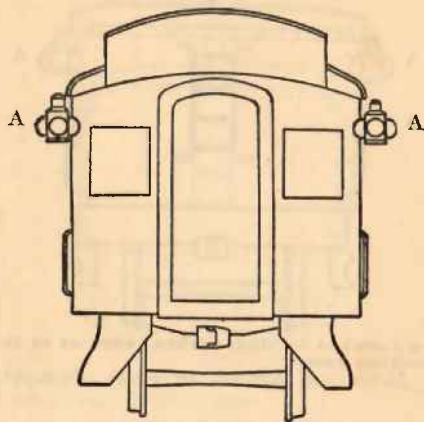

Rear of train by day.

Marker lamps not lighted, or green flags at A A as markers.

Fig. 5.

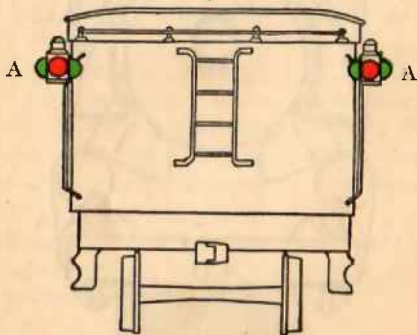

Running forward by night, without cars, or at the rear of a train pushing cars on single track and with the current of traffic on two or more tracks.

Lights at A A as markers, showing green to the front and side and red to the rear.

Fig. 7.

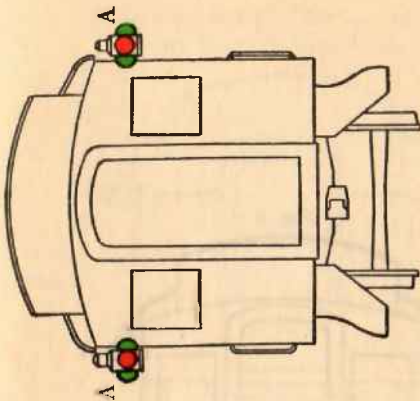

Rear of train by night while running on single track, and with the current of traffic on two or more tracks.  
Lights at A A as markers, showing green to the front and side and red to the rear.

Fig. 6.

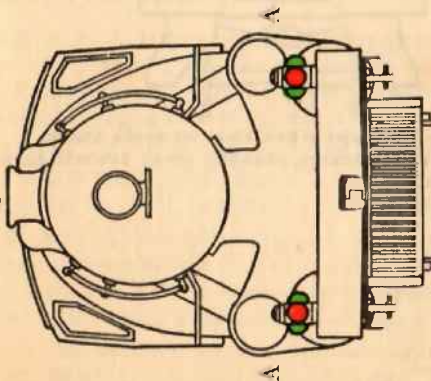

Running backward by night, without cars, or at the rear of a train pushing cars on single track, and with the current of traffic on two or more tracks.

Lights at A A as markers, showing green to side and in direction engine is moving and red in opposite direction.

Fig. 8.

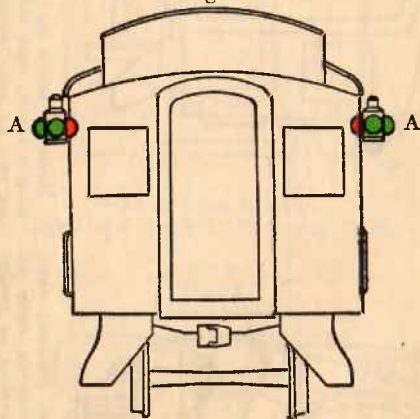

**Rear of train by night when clear of main track.**

Lights at A A as markers, showing green toward engine, side and to rear.

Fig. 9.

(This illustration is for a road which uses the right hand track.)

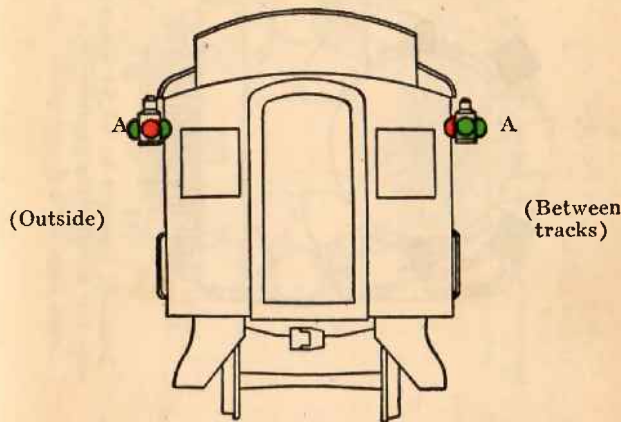

**Rear of train by night running against the current of traffic on two tracks.**

Lights at A A as markers, showing green to front and side and green to the rear on the side next to the main track on which the current of traffic is in the direction the train is moving and red to the rear on the opposite side.

19 (A). A train not equipped to display the prescribed markers will display a red flag by day and a red light by night, to indicate the rear of the train.

19 (B). Unless otherwise provided, train crews arriving at terminals must not remove the markers until the train has been delivered to connecting crew or is clear of the main track and the switch is closed.

20. All sections except the last will display two green flags, and, in addition, two green lights by night in the places provided for that purpose on the front of the engine.



Fig. 10.

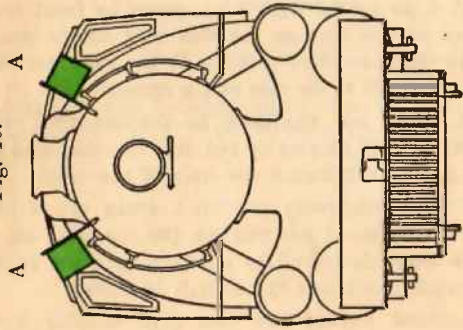

Running forward by day displaying signals for a following section.

Green flags at A.A.

Fig. 11.

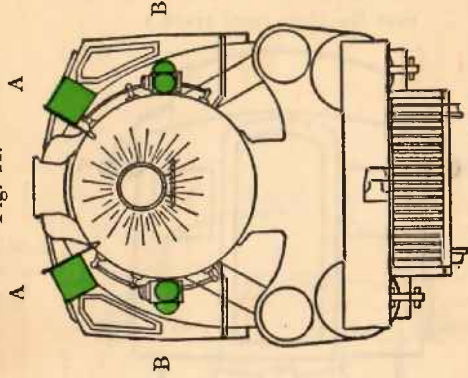

Running forward by night displaying signals for a following section.

Green flags at A.A and green lights at B.B.

Fig. 12.

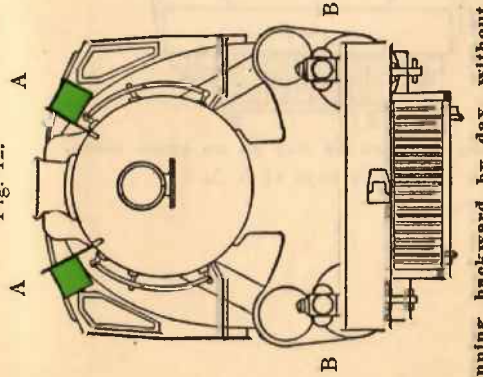

Running backward by day, without cars or at the rear of a train pushing cars, and displaying signals for a following section.

Green flags at A.A.

Marker lamps not lighted, or green flags at B.B as markers.

Fig. 13.

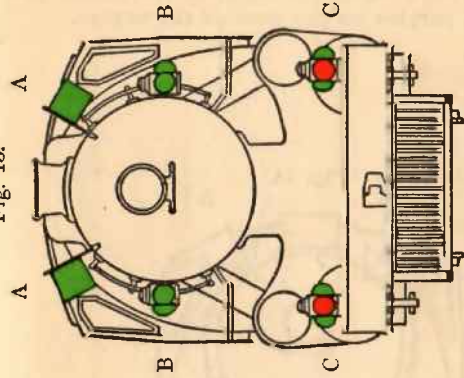

Running backward by night, without cars or at the rear of a train pushing cars, and displaying signals for a following section.

Green flags at A.A.

Green lights at B.B.

Lights at C.C as markers, showing green to side and in direction engine is moving and red in opposite direction.

21. Extra trains will display two white flags and, in addition, two white lights by night, in the places provided for that purpose on the front of the engine.

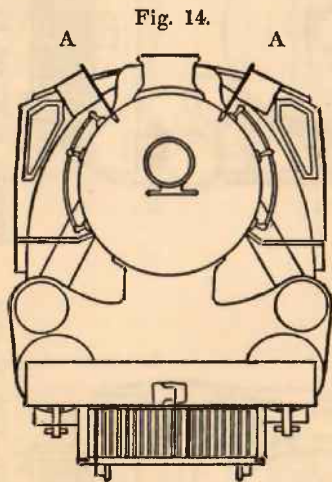

Running forward by day as an extra train.  
White flags at A A.

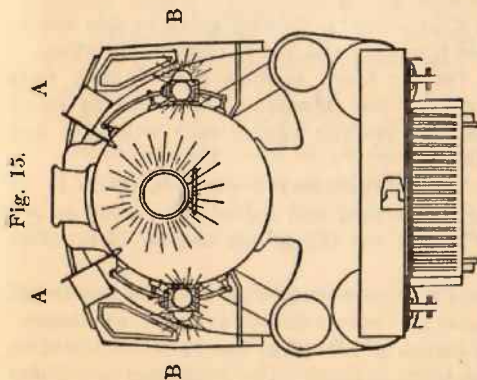

Fig. 15.

Running forward by night as an extra train.  
White flags at A A and white lights at B B.

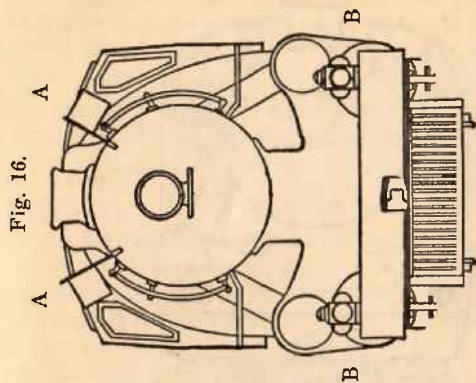
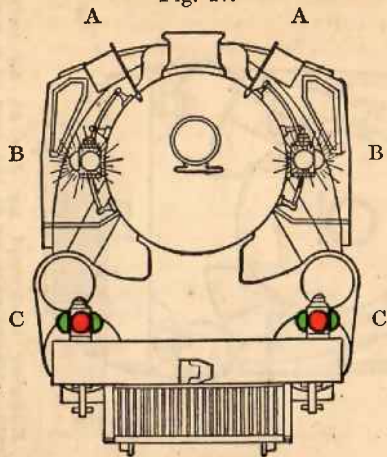

Fig. 16.

Running backward by day as an extra train, without cars, or at the rear of a train pushing cars.  
White flags at A A.  
Marker lamps not lighted, or green flags at B B as markers.

Fig. 17.



Running backward by night as an extra train, without cars, or at the rear of a train pushing cars.

White flags at A A.  
White lights at B B.

Lights at C C as markers, showing green to side and in direction engine is moving and red in opposite direction.

22. When two or more engines are coupled, each engine shall display the signals as prescribed by Rules 20 and 21 and the leading engine only will give and answer signals.

23. One flag or light displayed where in Rules 19, 20 and 21 two are prescribed will indicate the same as two except under Fig. 9; but the proper display of all train signals is required.

25. Each car of a passenger train must be connected with the engine by communicating signal appliance.

26. A blue signal, displayed at one or both ends of an engine, car or train, indicates that workmen are under or about it; when thus protected it must not be coupled to or moved. Each class of workmen will display the

blue signals and the same workmen are alone authorized to remove them. Other equipment must not be placed on the same track so as to intercept the view of the blue signals, without first notifying the workmen.

When emergency repair work is to be done under or about cars in a train and a blue signal is not available, the engineman and fireman will be notified and protection must be given those engaged in making the repairs.

#### USE OF SIGNALS.

27. A signal imperfectly displayed, or the absence of a signal at a place where a signal is usually shown, must be regarded as the most restrictive indication that can be given by that signal, except that when the day indication is plainly seen, it will govern.

Engine and train crews using a switch where the switch light is imperfectly displayed or absent, must, if practicable, correct or replace the light.

A signal imperfectly displayed or the absence of a signal at a place where a signal is usually shown must be promptly reported to the superintendent.

28. A green and white signal will be used to stop a train only at the flag stations indicated on its schedule.

29. When a signal, except a fixed signal, is given to stop a train, it must, unless otherwise provided, be acknowledged as prescribed by Rules 14 (g) or (h).

30. The engine bell must be rung when an engine is about to move and while approaching and passing public crossings at grade, stations and through tunnels and snow sheds.

31. Enginemen must sound whistle signal as prescribed by Rule 14 (l) approaching tunnels and snow sheds and when view is restricted by weather or other conditions should frequently sound the whistle to warn trackmen and others. The whistle must be sounded where required by rule or law but except in case of



emergency must not be sounded while passing or being passed by a passenger train.

In case of whistle failure, speed must be reduced and the bell rung continuously when approaching and passing through stations, yards, over highway crossings, and around curves.

32. The unnecessary use of either the whistle or the bell is prohibited.

33. Watchmen stationed at public crossings must use stop signals, when necessary to stop trains. They will use prescribed signals to stop highway traffic.

34. All members of train and engine crews must, when practicable, communicate to each other by its name, the indication of each signal affecting the movement of their train or engine.

35. The following signals will be used by flagmen:

Day signals—A red flag,

Torpedoes and Fusees.

Night signals—A red light,

Torpedoes and Fusees.

### SUPERIORITY OF TRAINS.

S-71. A train is superior to another train by right, class or direction.

Right is conferred by train order; class and direction by time-table.

Right is superior to class or direction.

Direction is superior as between trains of the same class.

D-71. A train is superior to another train by right or class.

Right is conferred by train order; class by time-table. Right is superior to class.

S-72. Trains of the first class are superior to those of the second; trains of the second class are superior to those of the third; and so on.

Trains in the direction specified by the time-table are

superior to trains of the same class in the opposite direction.

D-72. Trains of the first class are superior to those of the second; trains of the second class are superior to those of the third; and so on.

73. Extra trains are inferior to regular trains.

### MOVEMENT OF TRAINS.

82. Time-table schedules, unless fulfilled, are in effect for twelve hours after their time at each station.

Regular trains more than twelve hours behind either their schedule arriving or leaving time at any station lose both right and schedule, and can thereafter proceed only as authorized by train order.

S-83. A train must not leave its initial station on any division, or subdivision, or a junction, or pass from one of two or more tracks to single track, until it has been ascertained whether all trains due, which are superior, or of the same class, have arrived or left.

S-83 (A). At a meeting point, the train register will not be accepted as evidence of the arrival of an extra train.

D-83. A train must not leave its initial station on any division, or subdivision, or a junction, until it has been ascertained whether all superior trains due have left.

83 (A). Stations at which train registers are located will be designated by time-table.

Conductors of all trains, or enginemen of engines without conductors, will register their trains in the train register at points designated by time-table. Where authorized, register ticket may be accepted by the operator who will register for the conductor and report trains to the train dispatcher from train register.

Conductors must fill out train register check on the prescribed form and deliver or have it delivered to engine man before leaving register stations.

The number of a section of a regular train will be

spelled out on clearances, train registers and register tickets.

83 (B). Unless otherwise provided, a train must not leave its initial station on any division, or subdivision, without a clearance.

Operators must not issue a clearance to a train at its initial station or starting point on any subdivision without authority from the train dispatcher, except in case of failure of means of communication. In case of failure of means of communication, the clearance will be endorsed, wire failure.

A train returning to its regular route at other than an initial station after having been detoured must not resume its schedule unless directed by train order to do so.

In starting trains from a point where there is no train register, or when the conductor and engineman are to be relieved of the duty of ascertaining what trains have arrived or left, train order Form V will be used.

84. A train must not start until the proper signal is given.

85. When a train of one schedule is on the time of another schedule of the same class in the same direction, it will proceed on its own schedule.

Trains of one schedule may pass trains of another schedule of the same class and extra trains may pass or run ahead of second and third class trains and extra trains.

Third class trains may pass or run ahead of second class trains.

A section may pass and run ahead of another section of the same schedule, first exchanging train orders, signals and numbers, with the section to be passed. The change in sections must be reported from the next available point of communication.

86. In automatic block signal territory, unless otherwise provided, an inferior train must clear a superior train in the same direction sufficiently so as to avoid

giving a restrictive signal indication to the following train; but must clear a first class train not less than five minutes.

In non-automatic block signal territory, unless otherwise provided, an inferior train must clear a superior train in the same direction not less than five minutes; but must be clear at the time a first class train in the same direction is due to leave the next station in the rear where time is shown; but not less than five minutes.

87. Necessary identification of trains must be made at meeting points and at passing points.

S-87. An inferior train must keep out of the way, of opposing superior trains and failing to clear the main track by the time required by rule must be protected as prescribed by Rule 99.

Extra trains must clear the time of opposing regular trains not less than five minutes, unless otherwise provided, and will be governed by train orders with respect to opposing extra trains.

S-88. At meeting points between extra trains, the train in the inferior time-table direction must take the siding unless otherwise provided.

Trains must pull into the siding when practicable; if necessary to back in, the train must first be protected as prescribed by Rule 99.

S-89. At meeting points, the inferior train must take the siding and clear the time of the superior train not less than five minutes except at schedule meeting points between trains of the same class where the inferior train must clear the main track before the leaving time of the superior train.

The inferior train must pull into the siding when practicable. If necessary to back in, it must be protected as prescribed by Rule 99.

S-89 (A). At schedule meeting points between trains of the same class, the superior train must stop clear of

the switch used by the train to be met in going on siding unless switch is properly lined and track clear.

At train order meeting points, the train holding the main track must stop clear of the switch used by the train to be met in going on siding unless the train to be met is clear of the main track and switch is properly lined.

S-90. On trains equipped with communicating signal system the conductor must give signal 16 (l) to the engineman immediately after passing the last station but not less than one mile preceding a schedule meeting point with a train of the same or superior class or a point where by train order it is to meet or has to wait for an opposing train. The engineman will immediately reply with signal 14 (n). If the engineman fails to answer by signal 14 (n), the conductor must take immediate action to stop the train.

On other trains, the engineman will give signal 14 (n) at least one mile before reaching a meeting or waiting point.

91. Unless some form of block signals is used, trains in the same direction must keep not less than ten minutes apart, except in closing up at stations.

92. A train must not leave a station in advance of its schedule leaving time.<sup>1/2</sup>

93. Within yard limits the main track may be used, clearing first class trains when due to leave the last station where time is shown, but not less than five minutes. In case of failure to clear the main track, protection must be given as prescribed by Rule 99.

Within yard limits the main track may be used without protecting against second and inferior class, extra trains and engines.

Second and inferior class, extra trains and engines must move within yard limits at restricted speed.

When running against the current of traffic or on a portion of two or more tracks used as single track, all

trains and engines must move within yard limits at restricted speed.

94. A train which overtakes another train so disabled that it cannot proceed will pass it, if practicable, and if necessary will assume the schedule and take the train orders of the disabled train, proceed to the next available point of communication, and there report to the train dispatcher. The disabled train will assume the right or schedule and take the train orders of the last train with which it has exchanged, and will, when able, proceed to and report from the next available point of communication.

95. Two or more sections may be run on the same schedule.

Each section has equal time-table authority.

A train must not display signals for a following section, except as prescribed by Rule 85, without orders from the superintendent.

S-96. Signals must not be ordered displayed to, nor taken down at, other than a register station for the train displaying the signals.

S-97. Unless otherwise provided, extra trains must not be run without train orders.

D-97. Where specified on the time-table, extra trains may be run with the current of traffic without train orders provided they secure proper clearance. The operator must secure authority from the train dispatcher before issuing clearance. Such clearances will be numbered and may be cancelled by train order.

Work extras must not be run without train orders<sup>1</sup> and must move with the current of traffic, unless otherwise provided.

98. Trains must approach the end of two or more tracks, junctions, railroad crossings at grade, and draw-bridges, prepared to stop, unless the switches are properly lined, signals indicate proceed, and track is clear. Where required by rule or law, trains must stop.

98 (A). Where railroad crossings are protected by gates, if the gate is against the route to be used, trains or engines on that track must stop and remain at least fifty feet from fouling the crossing until the gate is changed to the stop position on the other line.

99. When a train stops under circumstances in which it may be overtaken by another train, the flagman must go back immediately with flagman's signals a sufficient distance to insure full protection, placing two torpedoes, and when necessary, in addition, displaying lighted fuses. When recalled and safety to the the train will permit, he may return.

When the conditions require, he will leave the torpedoes and a lighted fusee.

The front of the train must be protected in the same way when necessary by the forward brakeman, fireman, or other competent employe.

When a train is moving under circumstances in which it may be overtaken by another train, the flagman must take such action as may be necessary to insure full protection. By night, or by day when the view is obscured, lighted fusees must be thrown off at proper intervals.

When day signals cannot be plainly seen, owing to weather or other conditions, night signals must also be used. Conductors and enginemen are responsible for the protection of their trains.

99 (A). When it is known by engineman that his train will be delayed, he must immediately whistle out flagman.

99 (B). When a flagman is sent out with instructions affecting a train's authority to proceed, three copies of the instructions must be made, one copy to be given to the flagman who must show this to the engineman of the train or trains affected, one copy to the engineman of the train he is sent on (if sent on a train), and the other copy to be retained by the conductor. When a flagman is sent to a siding on a train, he will ride on the engine

and the engineman must stop and let him off at the first switch at the station to which he is sent.

Precaution must be taken to stop so as to block the switch until opposing trains are notified that they will be flagged or held.

100. When the flagman goes back to protect the rear of the train and is left behind, another trainman must take his place on the train.

101. Trains must be fully protected against any known condition not covered by the rules, which interferes with their safe passage.

101 (A). If any defect or condition which might cause an accident is discovered in track, bridges or culverts, the telegraph or telephone must not be depended on to notify other trains; a flagman must be left.

If any member of the train or engine crew has reason to believe that their train has passed over any dangerous defect, the train must be stopped at once and proper protection provided. A prompt report must be made.

101 (B). When overtaken by severe storms or indication of high water, or any condition which threatens damage, trains must proceed at restricted speed, so that they can be stopped in time to prevent accident, and if in doubt as to being able to proceed safely, train must be placed on siding and remain there until it is safe. Conductors and enginemen must make careful inquiries at all stopping places, and when thought advisable make extra stops to ascertain the extent and severity of storms; examine bridges and culverts or other places subject to damage by high water, and if they find any indication of danger, must report by wire to the train dispatcher.

102. When a train is disabled or stopped suddenly by an emergency application of the air brakes or other causes, adjacent tracks as well as tracks of other railroads that are liable to be obstructed must at once be

protected until it is ascertained they are safe and clear for the movement of trains.

102 (A). When for any reason, an engine leaves its train or part of its train on the main track, a sufficient number of hand brakes must be set to keep train from moving, and at night or when the view is obscured, torpedoes must be placed at a safe distance in advance of rear portion of the train to warn enginemen returning, and at night a light must be placed on the front end of the rear portion of the train. When conditions require it, a flagman must protect returning engine.

103. When cars are pushed by an engine (except when shifting or making up trains in yard), a trainman must take a conspicuous position on the leading car, and when shifting over public crossings at grade not protected by a watchman or gates, a member of the crew must protect the crossing. When protecting crossings, a man must be on the ground at crossing.

103 (A). When a train is cut at public grade crossings a trainman must, when practicable, protect traffic against approaching trains.

104. Conductors are responsible for the position of switches used by them and their trainmen, except where switchtenders are stationed. Switches must be properly lined after having been used.

A switch must not be left open for a following train or engine unless in charge of a trainman of such train or engine.

When practicable, the engineman must see that the switches near the engine are properly lined.

A train or engine must not foul a track until switches connected with a movement are properly lined and when waiting to cross from one track to another, and during the approach or passage of a train on tracks involved, all switches connected with the movement must be secured in the normal position. Switches must not be

restored to normal position until the movement is completed or clear of the main track involved.

Trains or engines leaving a main track must, when practicable, pull clear of the main track before stopping for trainman to attend the switch.

Where trains or engines are required to be reported clear of main track, such report must not be made until switch has been secured in its normal position.

Note.—Rule 104 applies only to hand operated switches.

104 (A). Employes must stand not less than 20 feet from the switch stand and, when practicable, on the opposite side of the track while a train is closely approaching or passing and know that main track switches are locked in proper position.

Employes alighting from a moving train must, when practicable, get off from the read end of rear car, but when this cannot be done and safety permits, must get off train from side opposite the switch stand.

After using a switch, it must be seen that points fit and it is properly secured and locked. If lock is missing or defective, immediate report must be made to train dispatcher.

Derails must be set in derailing position, except while being used; where equipped with locks they must be locked.

105. Unless otherwise provided, trains using a siding must proceed at restricted speed.

Sidings of an assigned direction must not be used in a reverse direction unless authorized by the superintendent or in an emergency under flag protection.

106. Both the conductor and the engineman are responsible for the safety of the train and the observance of the rules, and, under conditions not provided for by the rules, must take every precaution for protection.

107. Trains or engines must run at restricted speed in passing a train receiving or discharging traffic at a

station, except where proper safeguards are provided, or the movement is otherwise protected. They must not pass between it and the platform at which traffic is being received or discharged, unless the movement is properly protected.

108. In case of doubt or uncertainty, the safe course must be taken.

109. Bulletins will be numbered consecutively beginning with No. 1 January first of each year. They will be issued and cancelled by the superintendent.

Train orders will be used when the conditions are of a temporary or serious nature.

Members of train, yard and engine crews must consult bulletins. Conductors, enginemen and foremen of yard engines must receipt for last and all previous bulletins by recording their name and the number of the last bulletin in the place provided and will be held accountable for the observance of all bulletins posted prior to their departure. The time and date posted will be endorsed on the face of each bulletin. The location of bulletin boards may be designated by time-table.

D-151. Where two main tracks are in service trains must keep to the right unless otherwise provided.

Where three or more main tracks are in service they shall be designated by numbers and their use indicated by special instructions.

D-152. When a train crosses over to, or obstructs another track, unless otherwise provided, it must first be protected as prescribed by Rule 99 in both directions on that track.

#### TRAIN ORDER SIGNALS.

The following signals will appear where conditions require their use.

The indications are given by the position of the arms, by lights of the prescribed color, or by both.

Where the semaphore is used the governing arm is

displayed to the right of the signal mast as viewed from an approaching train, and on two or more tracks, governs trains moving against the current of traffic the same as if moving with the current of traffic.

200 A.

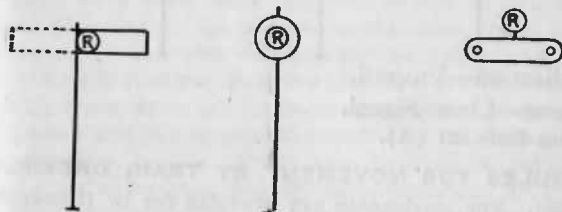

Indication—Stop for Orders.

Name—Stop Signal.

See Rule 221 (A).

200 B.

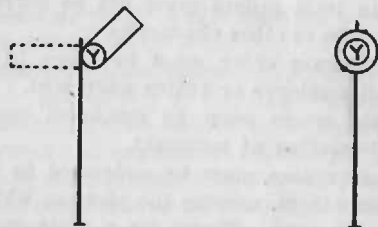

Indication—Proceed Under Clearance or Train Order and Clearance.

Name—19 Order Signal.

See Rule 221 (B).

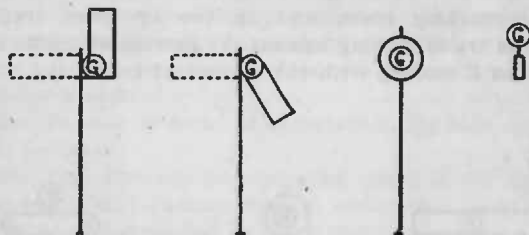

Indication—Proceed.

Name—Clear Signal.

See Rule 221 (A).

#### RULES FOR MOVEMENT BY TRAIN ORDERS.

201. For movements not provided for by time-table, train orders will be issued by authority and over the signature of the superintendent and contain only information or instructions essential to such movements.

They must be brief and clear; in the prescribed forms when applicable; and without erasure, alteration or interlineation.

Figures in train orders must not be surrounded by brackets, circles or other characters.

202. Each train order must be given in the same words to all employes or trains addressed.

203. Train orders must be numbered consecutively each day, beginning at midnight.

204. Train orders must be addressed to those who are to execute them, naming the place at which each is to receive his copy. Those for a train must be addressed to the conductor and engineman, and also to any one who acts as its pilot. A copy for each employe addressed must be supplied by the operator.

Orders addressed to operators restricting the movement of trains must be respected by conductors and enginemen the same as if addressed to them.

Enginemen must show train orders to firemen and when practicable to forward trainmen. Conductors must show train orders, when practicable, to trainmen.

204 (A). Unless otherwise provided when a train has more than one engine in service, each engineman must be provided with copies of all train orders and clearance.

205. Each train order must be written in full in a book provided for the purpose at the office of the train dispatcher; and with it recorded the names of those who have signed for the order; the time and the signals which show when and from what offices the order was repeated and the responses transmitted; and the train dispatcher's initials. These records must be made at once and never from memory or memoranda.

206. In train orders, regular trains will be designated by number as "No. 10," and sections as "Second 10," adding engine numbers if desired. Extra trains will be designated by engine numbers, and the direction as "Extra 798, 'East' or 'West'." For the movement of an engine of another company the initials as well as the engine number will be used.

Even hours as "10 00 A.M." must not be used in stating time in train orders.

In transmitting train orders by telegraph, time may be stated in figures only or duplicated in words.

In transmitting train orders by telephone, the numbers of trains and engines in the address may be pronounced and then spelled, letter by letter if so desired. All stations and numerals in the body of an order must first be plainly pronounced and then spelled, letter by letter thus: Aurora, A-u-r-o-r-a, and One Naught Five, O-n-e N-a-u-g-h-t F-i-v-e.

The letters duplicating names of stations and numerals will not be written in the order book nor upon train orders, except time which may be duplicated in words.



When train orders are transmitted by telegraph, the train dispatcher must underscore each word and figure at the time it is repeated. When transmitted by telephone, he must write the order as he transmits it and underscore as prescribed above.

When two or more engines are coupled, the number of the leading engine only, will be used in train orders, except when helper engines or other engines are placed on the head end of a train over a portion of a subdivision, the road engine number will be used.

207. To transmit a train order, the signal "31" or the signal "19" followed by the direction must be given to each office addressed, the number of copies being stated, if more or less than three—thus, "31, West, copy 5", or "19, East, copy 2".

Note.—Where forms "31" and "19" are not both in use, the signal may be omitted.

208. A train order to be sent to two or more offices must be transmitted simultaneously to as many of them as practicable. When not sent simultaneously to all, the order must be sent first to the superior train.

The several addresses must be in the order of superiority of trains, each office taking its proper address, and, when practicable, except in automatic block signal territory, must include the operator at the meeting or waiting point.

Copies of the order addressed to the operator at the meeting or waiting point must be delivered to the trains affected until all have arrived from one direction.

A train order must not be sent to a superior train at the meeting or waiting point if it can be avoided. When an order is so sent, the fact will be stated in the order and special precautions must be taken to insure safety.

S-208 (A). A train that is advanced to a station where the opposing train gets the order at the meeting or waiting point, must approach that station expecting to find the train receiving the order on the main track.

209. Operators receiving train orders must write or typewrite them in manifold during transmission. They must retain a copy of each train order. The time, complete, and the signature of the operator, must be in his handwriting.

209 (A). If the requisite number of copies cannot be made at one writing, operators must make others from the original copy, and repeat to the train dispatcher from the new copies each time additional copies are made. The name of the original receiving operator will be shown with the initials of the operator who recopies the order. The train dispatcher will place notation in train order book, of the repetition, but the original date of issue and time completed will not be changed. When an error is made in transmitting a train order that train order must be immediately destroyed and if re-issued, given another number. When train orders are annulled on other than the date of issue, the date as well as the number of the order annulled, must be designated in the annulment order.

210. When a "31" train order has been transmitted, operators must, unless otherwise directed, repeat it at once from the manifold copy in the succession in which the several offices have been addressed, and then write the time of repetition on the order. Each operator receiving the order should observe whether the others repeat correctly.

The conductor or engineman and others addressed must read it to the operator and then sign it, and the operator will send their signatures preceded by the number of the order to the train dispatcher. The response "complete," and the time, with the initials of the superintendent, will then be given by the train dispatcher. Each operator receiving this response will then write on each copy the word "complete," the time, and his last name in full, and then deliver a copy to each person addressed, except that when the order is signed by the



conductor, he must personally deliver a copy of it to each engineman; the engineman will then read the order to the conductor before proceeding.

211. When a "19" train order has been transmitted, operators must, unless otherwise directed, repeat it at once from the manifold copy, in the succession in which the several offices have been addressed. Each operator receiving the order should observe whether the others repeat correctly. When the order has been repeated correctly by an operator, the response "complete," and the time, with the initials of the superintendent, will be given by the train dispatcher. The operator receiving this response will then write on each copy the word "complete," the time, and his last name in full, and personally deliver a copy to each person addressed, without taking his signature. But when delivery to engineman will take the operator from the immediate engineman of his office, the engineman's copy will be delivered by conductor or brakeman.

When a "19" train order restricting the superiority of a train is issued for it at the point where such superiority is restricted, the train must be brought to a stop before delivery of the order.

212. When so directed by the train dispatcher, a train order may be acknowledged before repeating, by the operator responding: "number of train order to train number, X" with the operator's initials and office signal. The operator must then write on the order his initials and the time.

213. "Complete" must not be given to a train order for delivery to an inferior train until the order has been repeated or the "X" response sent by the operator who receives the order for the superior train.

214. When a train order has been repeated, including the signature of the superintendent, or "X" response sent, and before "complete" has been given, the order must be treated as a holding order for the train ad-

dressed, but must not be otherwise acted on until "complete" has been given.

If the means of communication fails before an office has repeated an order or has sent the "X" response, the order at that office is of no effect and must be there treated as if it had not been sent.

216. For train orders delivered by the train dispatcher the requirements as to the record and delivery are the same as at other offices.

216 (A). When the train dispatcher issues a train order that is to be delivered to a train by the dispatcher, a carbon copy of the body of the order must be made in the dispatcher's train order book at the time the order is written on form "19" or "31" and this copy underscored as required by Rule 206.

217. A train order to be delivered to a train at a point not a train order office, or at one at which the office is closed, must be addressed to "C and E. ...." at ..... care of ....." and forwarded and delivered by the conductor or other person in whose care it is addressed. When form 31 is used, "complete" will be given upon the signature of the person by whom the order is to be delivered, who must be supplied with copies for the conductor and engineman addressed, and a copy upon which he shall take their signatures.) This copy he must deliver to the first operator accessible, who must at once transmit the signatures of the conductor and engineman to the train dispatcher and preserve the copy.

Orders so delivered must be acted on as if "complete" had been given in the usual way.

For orders which are sent, in the manner herein provided, to a train, the superiority of which is thereby restricted, "complete" must not be given to an inferior train until the signatures of the conductor and engineman of the superior train have been sent to the train dispatcher.

217 (A). On railroads that use form "19" orders exclusively, a train order to be delivered to a train at a point not a train order office, or at one at which the office is closed, must be addressed to

"C. and E. ....at ..... care of ....." and when "complete" is given will be forwarded and delivered by the conductor or other person in whose care it is addressed, who must be supplied with copies for the conductor and engineman addressed, and when the superiority of their train is thereby restricted, a copy upon which he shall take their signatures. This copy he must deliver to the first operator accessible, who must at once transmit the signatures of the conductor and engineman to the train dispatcher and preserve the copy.

Orders so delivered must be acted on as if "complete" had been given in the usual way.

For orders which are sent in the manner herein provided to a train, the superiority of which is thereby restricted, "complete" must not be given to an inferior train until the signatures of the conductor and engineman of the superior train have been sent to the train dispatcher.

217 (B). When delivery of a train order as provided in Rules 217 or 217 (A) is to be made by another train, the train order must be addressed in care of conductor and engineman of delivering train, both supplied with copies and the conductor of delivering train will be held responsible for proper delivery and the engineman held responsible for stopping, to enable conductor to deliver train order. The conductor of train delivering orders must have clearance and copies of the orders for the conductor and engineman of the train addressed in addition to the copy for himself and his engineman. The numbers of the orders to be delivered must be included on the clearance for his train.

218. When a train is named in a train order by its

schedule number alone, all sections of that schedule are included, and each must have copies delivered to it.

219. An operator must not repeat or give the "X" response to a train order restricting the superiority of a train which has been cleared or of which the engine has passed his train-order signal until he has obtained the signatures of the conductor and engineman to the order.

220. Train orders once in effect continue so until fulfilled, superseded or annulled. Any part of an order specifying a particular movement may be either superseded or annulled.

Orders held by or issued for or any part of an order relating to a regular train become void when such train loses both right and schedule as prescribed by Rules 4 and 82, or its schedule is annulled.

When a conductor or engineman, or both, is relieved before the completion of a trip, all train orders and instructions held must be delivered to the relieving conductor or engineman. Such orders or instructions must be compared by the conductor and engineman before proceeding.

220 (A). Each train order must be delivered by the operator to the train addressed, unless the order is annulled by the train dispatcher.

When train orders are to be delivered to yard engines, they will be addressed "yard engs in care of yardmaster", "yardmaster" or "C. & E. yard engs", as desired.

221 (A). Unless otherwise provided, a fixed signal must be used at each train-order office which shall indicate "stop" when trains are to be stopped for train orders. When there are no orders, the signal must indicate "proceed".

When an operator receives the signal "31", or "19", followed by the direction, he must immediately display the "stop signal" for the direction indicated and then

reply "stop displayed", adding the direction, and until the orders have been delivered or annulled, the signal must not be restored to "proceed". While "stop" is indicated, trains must not proceed without a clearance.

If the fixed signal should fail to work properly, hand signals and clearance must be used.

Note.—In non-automatic block signal territory, the train-order signal may be used as a block signal.

221 (B). Where a three-position train-order signal is used, except in manual block territory, the "19 order signal" may be used for "19" train orders. When the order is addressed to the operator at the meeting or waiting point as provided in Rule 208, or when the order restricts the superiority of a train and is sent to a point where such superiority is restricted, the train dispatcher must instruct the operator to display the "stop signal".

When an operator receives the signal "19", followed by the direction, he must immediately display the "stop signal" or "19 order signal" for the direction indicated and then reply "stop displayed", or "19 displayed", adding the direction; and until the orders have been delivered or annulled, the signal must not be restored to "proceed". While "stop" or "19" is indicated, trains, must not proceed without a clearance.

221 (C). Clearance Form A must be delivered together with all train orders; before delivering, the operator must fill out the clearance showing thereon the number of orders and the number of each train order for that train and repeat from the clearance the address, the number of orders and the number of each train order to the train dispatcher, who will make a record of same in the train order book and if they are correct, will repeat the address and order numbers giving O.K., the time, and the superintendent's initials, which the operator will endorse on the clearance.

Except at initial stations when a clearance is deliver-

ed to a train for which there are no orders, the superintendent's initials will not be endorsed on the clearance but the operator must check with the train dispatcher before issuing clearance.

In case of failure of means of communication, the operator will fill out the clearance in the usual manner and endorse "wire failure" on the clearance. When communication is restored, the operator will notify the train dispatcher of the train and time cleared and the numbers of the orders delivered.

221 (D). Operators must make the requisite number of copies of clearance at one writing and preserve a copy. Conductors and enginemen must see that their train is correctly designated and that the order numbers on the clearance correspond with the order numbers delivered.

222. Operators must promptly record and report to the train dispatcher the time of arrival and departure of all trains and the direction of extra trains.

They must, when practicable, observe trains and report at once to the train dispatcher if the proper signals are not displayed.

223. The following signals and abbreviations may be used.

Initials for signature of the superintendent.  
Such office and other signals as are arranged by the superintendent.

C & E—for Conductor and Engineman.

X—Train will be held until train order is made "complete".

Com—for Complete.

O S—Train Report.

No—for Number.

Eng—for Engine.

Psgr—for Passenger.

Frt—for Freight.

Mins—for Minutes.

Jet—for Junction.

Dispr—for Train Dispatcher.

Opr—for Operator.

9—to clear the line for Train Orders, and for Operators to ask for Train Orders.

S D—for "stop displayed".

19 D—for "19 signal displayed".

Condr—for Conductor.

Engm—for Engineman.

Subdiv—for Subdivision.

M P H—for Miles per Hour.

M P—for Mile Post.

The usual abbreviations for the names of the months and stations.

224. Rules and special instructions relative to the movement of trains by telegraph must be complied with, when the telephone is used.

225. To relay a "31" train order, the train dispatcher must transmit it to the relaying operator, who will then transmit it to destination. The employe receiving it at destination must repeat it to the relaying operator, who on the copy he retains must underscore each word as it is repeated to him, and then repeat it to the train dispatcher, and if correct, the train dispatcher will reply "O K". After it has been signed by the proper persons at the point of destination, the signatures must be given to the relaying operator, who will then transmit them to the train dispatcher and "complete" will be given as per Rule 210, and relayed to destination.

226. To relay a "19" train order, the train dispatcher must transmit it to the relaying operator, who will then transmit it to destination. The employe receiving it at destination, must repeat it to the relaying operator, who on the copy he retains must underscore each word as it is repeated to him, and then repeat it to the train dispatcher, and if correct, "complete" will be given as per Rule 211, and relayed to destination.

## FORMS OF TRAIN ORDERS.

Note.—Forms with a prefix "S" are for single track, those with a prefix "D" are for two or more tracks; those without prefixes "S" or "D" are for single or two or more tracks. The prefix "S" and "D" to be printed in italics. The words and figures in italics in the forms are examples, indicating the manner in which the orders are to be filled out.

### S-A

#### FIXING MEETING POINTS FOR OPPOSING TRAINS.

- (1) *No 1 meet No 2 at B.*  
*No 3 meet Second 4 at B.*  
*No 5 meet Extra 95 east at B.*  
*Pagr Extra 652 East meet Extra 231 West and Extra 235 West at B.*
- (2) *No 2 and Second 4 meet No 1 and No 3 at C and Extra 95 west at D (and so on).*  
*No 1 meet No 2 at B Second 4 at C and Extra 95 east at D.*

Trains receiving these orders will run with respect to each other to the designated points and there meet in the manner prescribed by the rules.

### B.

#### DIRECTING A TRAIN TO PASS OR RUN AHEAD OF ANOTHER TRAIN.

- (1.) *No 1 pass No 3 at K.*  
Both trains will run according to rule to the designated point and there arrange for the rear train to pass promptly.
- (2.) *Extra 594 east run ahead of No 6 M to B.*  
The first-named train will run ahead of the second-named train between the designated points.
- (3.) *Extra 95 west run ahead of No 3 B until overtaken.*

3 The first-named train will run ahead of the second-named train from the designated point until overtaken, and then arrange for the rear train to pass promptly.

- (4.) *Extra 594 west* pass *No 3* at *K* and run ahead of *No 7 M* to *Z*.

When an inferior train receives an order to pass a superior train, <sup>437</sup>right is conferred to run ahead of the train passed from the designated point.

S-C.

GIVING RIGHT OVER AN OPPOSING TRAIN.

- (1.) *No 1* has right over *No 2 G* to *X*. <sup>453</sup>

If the second-named train reaches the point last named before the other arrives, it may proceed, keeping clear of the schedule of the opposing train as required by rule.

- (2.) *Extra 37 east* has right over *No 3 F* to *A*.

The regular train must not go beyond the point last named until the extra train has arrived, <sup>457</sup>unless directed by train order to do so.

These orders give right to the train first-named over the other train between the points named. <sup>459</sup>If the trains meet at either of the designated points, the first-named train must take the siding, unless the order otherwise prescribes.

- (3.) *Extra 77 west* has right over *Extra 78 east X* to *H*.

- (4.) *Extra 37 east* has right over *Extra 38 west B* to *G*.

This order gives right to the train first-named over the other train between the points named.

Neither train shall go beyond the point last named until the other train has arrived, <sup>461</sup>unless directed by train order to do so.

If the trains meet at either of the designated points, the first-named train must take the siding unless the order otherwise prescribes. <sup>462</sup>If the trains meet between the designated points, the second-named train will take the siding, unless the order otherwise prescribes. <sup>248 PM</sup>

Example (3.) of Form E or Example (1.) of Form S-E may be used in combination with these examples as shown in Examples (5.) and (6.).

- (5.) *Extra 37 east* has right over *Extra 38 west B* to *G* and wait at *C* until 9 59 a m

*D* 10 30 a m

*F* 10 55 a m

The first-named train must not pass the designated waiting points before the times given. Trains receiving this order must clear the time specified at the designated points or any intermediate station <sup>463</sup>not less than five minutes. <sup>618-69</sup>

- (6.) *Extra 37 east* has right over *extra 38 west B* to *G* wait at *C* until 9 59 a m for *extra 38 west*.

The first-named train must not pass the designated point before the time given <sup>464</sup>unless the second-named train has arrived. The second-named train must clear the time specified at the designated point or any intermediate station <sup>464</sup>not less than five minutes.

When right is given to the end of two or more tracks, the first-named train may proceed with the current of traffic but must not again enter single track unless the second-named train has arrived, or is directed by train order to do so.

C.

GIVING RIGHT OVER ANOTHER TRAIN IN THE SAME DIRECTION.

- (1.) *No 1* has right over *No 3 A* to *Z*.

- (2.) *Extra 21 west* has right over *Extra 25 west A* to *Z* and wait at *A* until 12 50 p m

*C* 1 10 p m

*E* 1 20 p m

- (3.) *No 401* (a second class train) has right over *Extra 25 west A* to *Z* and wait at *A* until 12 50 p m

*C* 1 10 p m

*E* 1 20 p m

These orders give right to the train first-named over the other train between the points named. The second-

named train must keep clear of the other as required by Rule 86. Under Examples (2.) and (3.) the first-named train must not pass the designated points before the times given.

E.

TIME ORDERS.

- (1.) *No 1* run 50 mins late *A* to *G*.

This makes the schedule time of the train named, between the stations designated, as much later as stated in the order, and any other train receiving the order is required to run with respect to this later time, as before required to run with respect to the regular schedule time. The time in the order should be such as can be easily added to the schedule time.

- (2.) *No 1* run 50 mins late *A* to *G* and 20 mins late *G* to *K*, etc.

This makes the schedule time of the train named, between the stations designated, as much later as stated in the order, and any other train receiving the order is required to run with respect to this later time as before required to run with respect to the regular schedule time. The time in the order should be such as can be easily added to the schedule time.

- (3.) *No 1* and *No 3* wait at *N* until 9 59 a m  
P 10 30 a m  
R 10 55 a m, etc.

The train, or trains, named must not pass the designated points before the times given. Other trains receiving the order are required to run with respect to the time specified at the designated points or any intermediate station where schedule time is earlier than the time specified in the order, as before required to run with respect to the schedule time of the train, or trains, named.

S-E.

- (1.) *No 1* wait at *H* until 9 59 a m for *No 2*.

The train first-named must not pass the designated point before the time given, unless the other train has

arrived. The train last named is required to run with respect to the time specified, at the designated point or any intermediate station where schedule time is earlier than the time specified in the order, as before required to run with respect to the schedule time of the train first-named.

F.

FOR SECTIONS.

- (1.) *Eng 20* display signals and run as *First 1 A* to *Z*.  
To be used when the number of the engine for which signals are displayed is unknown, and is to be followed by (2.), both being single-order examples.
- (2.) *Eng 25* run as *Second 1 A* to *Z*.
- (3.) *Second 1* display signals *B* to *Z* for *Eng 99*.
- (4.) *Engs 20 25* and *99* run as *First Second and Third 1 A* to *Z*.

To add an intermediate section, (5.) will be used.

- (5.) *Eng 85* display signals and run as *Second 1 A* to *Z*.  
Following sections change numbers accordingly.

The engine named will display signals and run as directed, and following sections will take the next higher number.

To drop an intermediate section, (6.) will be used.

- (6.) *Eng 85* is withdrawn as *Second 1* at *H*.  
Following sections change numbers accordingly.

The engine named will drop out at *H*, and following sections will take the next lower number.

To substitute one engine for another on a section, (7.) will be used.

- (7.) *Eng 18* instead of *Eng 85* display signals and run as *Second 1 R* to *Z*.

The second-named engine will drop out at *R*, and be replaced by the first-named engine.

Following sections need not be addressed.

If the second-named engine is the last section, the words "display signals and" will be omitted

To discontinue the display of signals, (8.) will be used.  
(8.) *Second 1* take down signals at *D*.

The train named will take down signals as directed, and a following section must not proceed beyond the designated point.

To pass one section by another, (9.) will be used.

(9.) *Engs 99* and *25* reverse positions as *Second and Third 1 H* to *Z*.

Conductors and enginemen of the trains addressed will exchange orders and signals. Following sections, if any, need not be addressed.

Each section affected by these orders must have copies and must arrange signals accordingly.

To annul a section for which signals have been displayed over a division, or any part thereof, when no train is to follow the signals, Form K must be used.

When sections are run to an intermediate point of a schedule, the train orders must specify which section or sections shall assume this schedule beyond such point.

When trains are running in sections of a schedule, the responsibility for a following section passing a leading section without proper authority rests with the leading section.

#### G.

##### EXTRA TRAINS.

(1.) *Eng 99* run extra *A* to *F*.

(2.) *Eng 99* run psgr extra *A* to *F*.

This gives the extra no right to occupy the main track between the switches of the siding at the point, last named.

(3.) *Eng 99* run extra *A* to *F* and return to *C*.

The extra must go to *F* before returning to *C*.

This gives the extra no right to occupy the main track between the switches of the siding at *F* on the going trip, and at *C* on the return trip.

(4.) *Eng 77* run extra leaving *A* on *Thursday Feb 17th* as follows with right over all trains

Leave *A* 11 30 p m

*C* 12 25 a m

*E* 1 47 a m

Arrive *F* 2 22 a m

This order may be varied by specifying the kind of extra and the particular trains over which the extra shall or shall not have right. Trains over which the extra is thus given right must clear the time of the extra as many minutes as an inferior train is required to clear the time of a first class train. The extra moving under this order must move within yard limits the same as required of any other extra train.

Examples of Form E and S-E may be used in connection with an extra train created by example (4.) of Form G, and the times at each point stated in that example have the same meaning as schedule times in examples under Form E.

(5.) *Eng 99* run extra *B* to *C*; this order is annulled at 7 10 p m.

A train receiving this order must, at the time specified, keep clear of the main track or protect itself in both directions, as prescribed by Rule 99.

(6.) On *Feb 17th* after 6 45 a m *eng 88* run extra *Z* to *G*. This form to be used to authorize in advance, a later movement of an extra train from a point at which there is no means of communication, or at which the office is closed.

The train must not leave the point first-named before the time specified in the order.

(7.) After extra 55 west has arrived at (or passed) *G*, *eng 66* run extra *G* to *B*.

This form to be used only when or where it is impracticable to give a positive meet with the first-named train and the train authorized by this form of order must know positively before leaving *G* that the first-named train has arrived at or passed *G*.



S-H.

WORK, EXTRA.

- (1.) *Eng 292* works extra 6 45 a m until 5 45 p m between D and E.

The work extra must, whether standing or moving, protect itself against extra trains within the working limits in both directions as prescribed by the rules. The time of regular trains must be cleared.

This may be modified by adding:

- (2.) *Not protecting against eastward extra trains.*

The work extra will protect only against westward extra trains. The time of regular trains must be cleared.

- (3.) *Not protecting against extra trains.*

Protection against extra trains is not required. The time of regular trains must be cleared,

304

When a work extra has been instructed by order to not protect against extra trains, and, afterward, it is desired to have it clear the track for, or protect itself after a certain hour against a designated extra, an order may be given in the following form:

- (4.) *Work Extra 292 clears, or protects against, Extra 76 east between D and E after 2 10 p m.*

Extra 76 east must not enter the working limits before 2 10 p m, and will then run expecting to find the work extra clear of the main track, or protecting itself, as the order may require.

To enable a work extra to work upon the time of a regular train, the following form will be used:

- (5.) *Work extra 292 protects against No 55, or \_\_\_\_\_ class trains, between D and E.*

The work extra may work upon the time of the train or trains mentioned in the order, and must protect itself against such train or trains. The regular train or trains receiving the order will run expecting to find the work extra protecting itself.

When a work extra is to be given exclusive right over all trains, the following form will be used.

- (6.) *Work Extra 292 has right over all trains between D and E 7 15 p m until 1 15 a m.*

This gives the work extra the exclusive right between the points designated between the times named.

- (7.) *On Feb 17th Eng 292 works extra 6 45 a m until 5 45 p m between D and E.*

This form to be used to authorize in advance a work extra from a point at which there is no means of communication, or at which the office is closed.

The working limits should be as short as practicable, to be changed as the progress of the work may require.

Work extras must give way to all trains as promptly as practicable.

Whenever extra trains are run over working limits they must be given a copy of the order sent to the work extra. Should the working order instruct a work extra to not protect against extra trains in one or both directions, extra trains must protect against the work extra; if the order indicates that the work extra is protecting itself against other trains, they will run expecting to find the work extra protecting itself.

Examples (1.) and (7.) confer no right to the work extra to occupy the main track between the switches of the siding at either of the points named.

D-H.

WORK EXTRA.

- (1.) *Eng 292 works extra on \_\_\_\_\_ track, or \_\_\_\_\_ tracks, 6 45 a m until 5 45 p m between D and E.*

The work extra must, whether standing or moving, protect itself within the working limits against extra trains moving with the current of traffic on the track or tracks named. The time of regular trains must be cleared.

This form may be modified by adding:

- (2.) *Not protecting against extra trains.*



Protection against extra trains is not required. The work extra may move against the current of traffic. The time of regular trains must be cleared.

To enable a work extra to work upon the time of a regular train, the following form may be used:

(3.) *Work extra 292 protects against No 55, or class trains, between D and E.*

The work extra may work upon the time of the train or trains mentioned in the order and must protect against such train or trains.

The regular train or trains receiving the order will run expecting to find the work extra protecting itself.

When it is desired to move a train against the current of traffic over the working limits, provision must be made for the protection of such movement.

When a work extra has been instructed by order to not protect against extra trains, and afterward, it is desired to have it clear the track for, or protect itself after a certain hour against a designated extra, an order may be given in the following form:

(4.) *Work extra 292 clears, or protects against, extra 76 east between D and E after 2 10 p m.*

Extra 76 east must not enter the working limits before 2 10 p m, and will then run expecting to find the work extra clear of the main track, or protecting itself, as the order may require.

When a work extra is to be given exclusive right over all trains, the following form will be used:

(5.) *Work extra 292 has right over all trains on and tracks between G and H 7 01 p m until 1 01 a m.*

This gives the work extra the exclusive right to the track, or tracks, mentioned between the points designated between the times named.

The working limits should be as short as practicable; to be changed as the progress of the work may require.

Work extras must give way to all trains as promptly as practicable.

Whenever extra trains are run over working limits, they must be given a copy of the order sent to the work extra. Should the working order instruct a work extra to not protect against extra trains, extra trains must protect against the work extra; if the order indicates that the work extra is protecting itself against other trains, they will run expecting to find the work extra protecting itself.

Example (1.) confers no right to the work extra to occupy the main track between the switches of the siding at either of the points named.

J.

#### HOLDING ORDER.

(1.) Hold No 2.

(2.) Hold all, or eastward, trains.

When a train has been so held it must not proceed until the order to hold is annulled, or an order given to the operator in the form:

These orders will be addressed to the operator and acknowledged in the usual manner, and will be delivered to conductors and engine men of all trains affected.

Form J will be used only when necessary to hold trains until orders can be given, or in case of emergency.

K.

#### ANNULING A SCHEDULE OR A SECTION.

(1.) No 1 due to leave A Feb 29th is annulled A to Z.

(2.) Second 5 due to leave E Feb 29th is annulled E to G.

(3.) No 401 due to leave E Feb 29th is annulled E to Z.

(4.) No 401 due to leave A Feb 29th has arrived at E and is annulled E to Z.

The schedule or section annulled becomes void between the points designated and cannot be restored.

Form K will not be combined with other forms of train orders.

The annulment of a schedule or section to a conductor or engineman, as per Form K, continues in effect to them, although the schedule or section number or the running order of their train be changed.

L.

ANNULLING AN ORDER.

- (1.) Order No 10 is annulled.

If an order which is to be annulled has not been delivered to a train, the annulling order will be addressed to the operator, who will destroy all copies of the order annulled but his own, and write on that:

*Annulled by Order No \_\_\_\_\_.*

An order which has been annulled must not be re-issued under its original number.

S-M.

ANNULLING PART OF AN ORDER.

- (1.) That part of order No 10 reading No 1 meet No 2 at S is annulled.  
(2.) That part of order No 12 reading No 3 pass No 1 at S is annulled.

Form S-M will be used only when that part of the order not annulled is clear in its wording.

D-M.

ANNULLING PART OF AN ORDER.

- (1.) That part of order No 10 reading Extra 263 west pass No 1 at S is annulled.  
(2.) That part of order No 12 reading No 3 pass No 1 at S is annulled.

Form D-M will be used only when that part of the order not annulled is clear in its wording.

S-P.

SUPERSEDING AN ORDER OR A PART OF AN ORDER.

This order will be given by adding to prescribed forms the words "instead of \_\_\_\_\_".

- (1.) No 1 meet No 2 at C instead of B.

An order which has been superseded must not be re-issued under its original number.

When a train is directed by train order to take siding for another train, such instructions apply only at the point designated in that order, and do not apply to the superseding order unless so specified.

P.

SUPERSEDING AN ORDER OR A PART OF AN ORDER.

This order will be given by adding to prescribed forms, the words "instead of \_\_\_\_\_".

- (1.) No 1 pass No 3 at C instead of B.

An order which has been superseded must not be reissued under its original number.

D-R.

PROVIDING FOR A MOVEMENT AGAINST THE CURRENT OF TRAFFIC.

- (1.) No 1 has right over opposing trains on \_\_\_\_\_ track C to F.

The designated train must use the track specified between the points named and has right over opposing trains on that track between those points. Opposing trains must not leave the point last named until the designated train arrives.

All trains between the points named moving with the current of traffic in the same direction as the designated train must, when practicable, receive a copy of the order, and may then proceed on their schedules, or rights.

This order may be modified as follows:

- (2.) After No 4 arrives at C, No 1 has right over opposing trains on \_\_\_\_\_ track C to F.

The train to be moved against the current of traffic must not leave the first-named point until the arrival of the first-named train.

A train must not be moved against the current of traffic until the track on which it is to run has been cleared of opposing trains.

D-S.

PROVIDING FOR THE USE OF A SECTION OF TWO OR MORE TRACKS AS SINGLE TRACK.

- (1.) \_\_\_\_\_ track will be used as single track between F and G.

If it is desired to limit the time for such use, add from 101 p m to 301 p m.

All trains must use the track specified between the stations named and will be governed by rules for single track.

Trains running against the current of traffic on the track named must be clear of the track at the expiration of the time named, or protected as prescribed by Rule 99.

T.

TIME TABLE RECEIPT.

Time table receipt to be used in accordance with Rule 4 (A).

Acceptance of this order is acknowledgment of receipt of time table No \_\_\_\_\_ effective \_\_\_\_\_ m \_\_\_\_\_ 19\_\_\_\_.

Trains and engines must not occupy main track after effective time and date of new time-table until the crews have received copies of the new time-table.

S-U.

ADVANCE AUTHORITY TO PROCEED FROM AN AUTOMATIC BLOCK STOP SIGNAL.

Advance authority for a train to proceed from an automatic block stop signal displaying stop indication when the train dispatcher knows there is no opposing train movement.

Pass signal \_\_\_\_\_

This order permits a train to proceed from an automatic block stop signal indicating stop and to proceed at restricted speed to the next block signal.

V.

CHECK OF TRAINS.

This form to be used when it is desired to give a train the information as prescribed by Rule 83(B).

All (superior) (first class) etc. trains due at C at or before 6 50 a m (have passed) (have arrived) (have left); as circumstances may require.

This may be modified by adding "except \_\_\_\_\_".

When the term "superior" is used, it includes trains made superior either by train order or time-table.

W.

TO AVOID STOPPING TRAINS FOR REGISTER OR CLEARANCE.

When it is desired to avoid stopping trains to register or receive clearance, the following form will be used:

- (1.) \_\_\_\_\_ will not register or require a clearance at \_\_\_\_\_ if the train order signal indicates proceed.
- (2.) \_\_\_\_\_ will register at \_\_\_\_\_ by register ticket.

When Example (2.) is used, a copy of the order will be given the operator at the register station.

FORMS OF BLANKS

FOR

Single and Two or More Tracks.

EAST AND WEST RAILROAD COMPANY.

A

A

CLEARANCE FORM A

.....M.....19.....

To ..... at .....

I have .....orders for your train.

No..... No..... No..... No..... No..... No.....

No..... No..... No..... No..... No..... No.....

There are no further orders for your train.

Block .....

.....  
.....  
.....  
.....  
.....  
.....  
.....  
.....

Superintendent

Operator or Signalman

Standard Train Order Blank for 31 Order.

FORM

**31**

FORM

**31**

Name \_\_\_\_\_ COMPANY

TRAIN ORDER No. 10

January 1 19 39

To \_\_\_\_\_ At \_\_\_\_\_

X \_\_\_\_\_ Initials \_\_\_\_\_ Opr.; 1 45 A M.

Each employe addressed must have a copy of this order.

Repeated at 2 20 A M.

Conductor or Engineman	Train	Made	Time	Operator
Jones Brown	45	Complete	2.20a.m.	Black
_____	_____	_____	_____	_____
_____	_____	_____	_____	_____
_____	_____	_____	_____	_____
_____	_____	_____	_____	_____
_____	_____	_____	_____	_____
_____	_____	_____	_____	_____
_____	_____	_____	_____	_____

Standard Train Order Blank for 19 Order.

FORM

**19**

FORM

**19**

Name \_\_\_\_\_ COMPANY

TRAIN ORDER No. 10

January 1 19 39

To \_\_\_\_\_ At \_\_\_\_\_

X \_\_\_\_\_ Initials \_\_\_\_\_ Opr.; 1 45 A M.

Each employe addressed must have a copy of this order.

Made \_\_\_\_\_ Complete time 2 16 P M. Black Opr.

## BLOCK SIGNAL AND INTERLOCKING RULES. DEFINITIONS.

**Block System.**—A series of consecutive blocks.

**Manual Block System.**—A series of consecutive blocks, governed by block signals operated manually, upon information by telegraph, telephone or other means of communication.

**Automatic Block System.**—A series of consecutive blocks governed by block signals, cab signals, or both, actuated by a train or engine, or by certain conditions affecting the use of a block

**Interlocking.**—An arrangement of signal appliances so interconnected that their movements must succeed each other in a pre-determined order. It may be operated manually or automatically.

**Interlocking Limits.**—The tracks between the home signals of an interlocking.

**Block Station.**—A place from which block signals are operated.

**Interlocking Station.**—A place from which an interlocking is operated.

**Block.**—A length of track of defined limits, the use of which by trains or engines is governed by block signals.

**Fixed Signal.**—A signal of fixed location indicating a condition affecting the movement of a train or engine.

**Cab Signal.**—A signal located in engineman's compartment or cab, indicating a condition affecting the movement of a train or engine and used in conjunction with interlocking signals and in conjunction with or in lieu of block signals.

**Block Signal.**—A fixed signal at the entrance of a block to govern trains or engines entering and using that block.

**Interlocking Signals.**—The fixed signals of an interlocking.

**Home Signal.**—A fixed signal at the entrance of a

route or block to govern trains or engines entering and using that route or block.

**Approach Signal.**—A fixed signal used in connection with one or more signals to govern the approach thereto.

**Dwarf Signal.**—A low home signal.

**Dual Control Switch.**—A power operated switch that is also equipped for hand throw operation.

**Medium Speed.**—A speed not exceeding thirty (30) miles per hour.

**Slow Speed.**—A speed not exceeding fifteen (15) miles per hour.

**Restricted Speed.**—Proceed prepared to stop short of train, obstruction, or anything that may require the speed of a train to be reduced.

## RULES GOVERNING THE MOVEMENT OF TRAINS IN THE SAME DIRECTION BY BLOCK SIGNALS.

251. On portions of the railroad, and on designated tracks so specified on the time-table, trains will run with reference to other trains in the same direction by block signals whose indications will supersede the superiority of trains.

253. The superintendent must be advised in advance, of any known condition that will delay the train or prevent it from making usual speed.

254. Except as affected by Rule 251, all Block Signal Rules and Operating Rules remain in force.

## RULES GOVERNING OPPOSING AND FOLLOWING MOVEMENT OF TRAINS BY BLOCK SIGNALS.

261. On portions of the railroad, and on designated tracks so specified on the time-table, trains will be governed by block signals, whose indications will supersede the superiority of trains for both opposing and following movements on the same track.

263. The superintendent must be advised in advance

of any known condition that will delay the train or prevent it from making usual speed.

264. Except as affected by Rule 261, all Block Signal Rules and Operating Rules remain in force.

### MANUAL BLOCK SIGNALS.

The following signals will appear where conditions require their use.

The indications are given by the position of the arms, by lights of prescribed color, or by both.

Except in special cases, signals are located over or upon the right of and adjoining the track to which they refer.

Semaphore arms that govern are displayed to the right of the signal mast as viewed from an approaching train.

### MANUAL BLOCK SIGNALS.

300 A

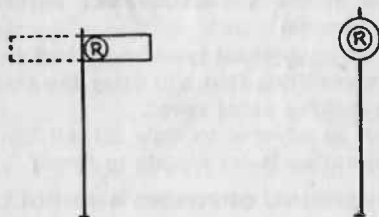

Indication—Stop.  
Name—Stop signal.

300 D

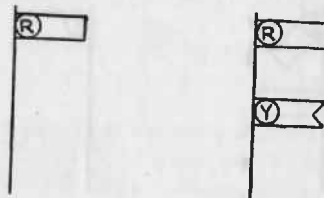

Indication—Stop.  
Name—Stop signal.

300 B

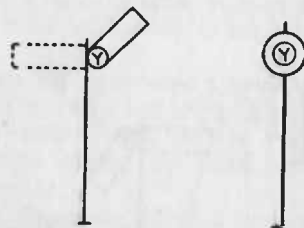

Indication—Block occupied—Proceed, prepared to stop short of train ahead.  
Name—Permissive signal.

300 E

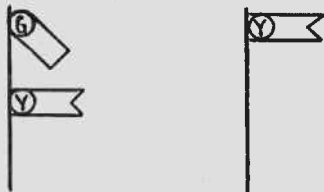

Indication—Train must reduce speed at once and move at restricted speed until the indication of the next governing signal can be determined.

Name—Restricting signal.

300 C

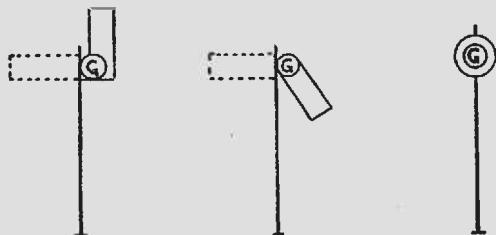

Indication—Proceed.

Name—Clear signal.

300 F

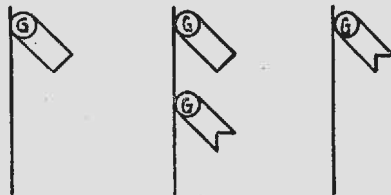

Indication—Proceed.

Name—Clear signal.

#### MANUAL BLOCK SYSTEM. RULES AND FORMS.

(To be used as designated on the time-table.)

305. Block signals govern the use of the blocks, but, unless otherwise provided, do not supersede the superiority of trains; nor dispense with the use or the observance of other signals whenever and wherever they may be required.

306. When a block station is open at an irregular hour, trains must be notified, when possible, by train order.

307. A train having entered a block on other than a proceed indication must not accept a proceed indication at any intermediate block station which was closed when such train entered the block, without receiving Clearance Form A.

308. When Clearance Form A is used information will be shown as to condition of block "clear" or "occupied". If block is occupied, train will proceed prepared to stop short of train ahead.

#### SIGNALMEN.

311. Signals must be kept in the position displaying the most restrictive indication, except when displayed for an immediate movement.

312. Appliances must be operated carefully and only

by those charged with that duty. If any irregularity affecting their operation is detected the signals must be displayed to give their most restrictive indication until repairs are made.

313. Signalmen must observe, as far as practicable, whether the indications of the signals correspond with the positions of the levers.

314. Signalmen must not make nor permit any unauthorized repairs, alterations or additions to the apparatus.

Any defects in the appliances must be promptly reported to the superintendent.

315. A block record must be kept at each block station on the prescribed form, beginning at 12 01 a m daily, showing the time all trains enter and clear the block, communicating code signals, and the time they are given and received.

### 316. COMMUNICATING CODE.

- 1.—Keep block signal in stop position for opposing train.
- 13.—I understand.
- 2.—Block clear.
- 5.—Block not clear of train other than passenger.
- 56.—Block not clear of passenger train.
- 38.—Opening block station. Answer by 2, 5 or 56.
- 39.—Closing block station, followed by 2.

If the block is clear, to be answered by 13, followed by 2. If the block is not clear, to be answered by 5 or 56.

When two or more tracks are used in the same direction, signalmen in using the communicating code must also specify the track.

Note.—When telephone is used, the code will be used without the numerals.

317. On single track, to admit a train to a block, the signalman must examine the block record, and if the block is clear of opposing trains and preceding passen-

ger trains, give "1 for ...." to the next block station in advance. If it is proper for the train to be admitted, the signalman in advance will reply "2 for ...." or "5 of ....". The signalman at the entrance of the block must then display the proper signal indication.

A train must not be admitted to a block which is occupied by an opposing train or by a passenger train, except as provided in Rule 333 or by train order. A train may be permitted to follow a train other than a passenger train into a block under permissive indication or Clearance Form A, when so directed by train dispatcher.

317 (A). To admit a train to a block to meet opposing trains at a closed block station or a siding between two open block stations, by train order, the signalman must examine the block record, and if the block is clear of all but the train or trains to be met, give "1 for .... except ....", to the next block station in advance.

The signalman receiving this signal, if there is no train in the block except the train or trains to be met, must display Stop-indication and then reply "13 for ..... except .....". The signalman at the entrance of the block must then display Stop-indication.

The approaching train will then be admitted to the block with a Clearance Form A reading, "Block clear except ..... Stop-indication is displayed for ..... to meet ..... as per order number....".

The authority of a signalman for the issuance of such clearance will be the receipt of a copy of the order to be repeated and signed by him and completed by the train dispatcher.

317 (B). To admit a train awaiting the arrival of an opposing train or trains to a block, the signalman must examine the block record and if the block is clear of all but the expected train or trains, give "1 for ..... except ...." to the next block station in advance.



The signalman receiving this signal, if the block is clear of all but the train or trains to be met, must display Stop-indication and then reply "13 for ... except .....". The signalman at the entrance of the block must then display the proper signal indication.

The train must be brought to a stop and may then be given Clearance Form A reading, "Block clear except ..... Stop-indication is displayed for ..... to meet .....". A train receiving such clearance must not leave until the opposing train has arrived.

317 (C). To permit a train to follow a train into a block by train order, the signalman must examine the block record, and, if the block is clear of all but the train to be followed, give "1 for ...." to the next block station in advance. The signalman receiving this signal, if there is no train in the block except the train behind which the following movement is authorized, must reply "5 of ..... 13 for ....." or 56 "of ..... 13 for ....." . The approaching train will then be admitted to the block with Clearance Form A reading, "Block clear except ..... Stop-indication is displayed for Order No. ....". A copy of the train order will be addressed to the signalman at the entrance of the block and also to the signalman at the next block station in advance.

317 (D). In case a train has left an open block station expecting to reach the next open block station for an opposing superior train and fails to do so, and there are one or more closed block stations or sidings between the two open block stations, the train dispatcher, after holding the superior train 5 minutes or more beyond its schedule leaving time or train order waiting time, may authorize the release of the superior train with a train order in the following form;

"..... left .... at .... and has not arrived at .... Operator ..... will release No. ....".

Clearance Form A will then be issued reading:

"Block clear except ..... Stop-indication is displayed for Order No. ....".

318. To admit a train to a block, the signalman must examine the block record, and display proper signal indication.

A train must not be admitted to a block which is occupied by a passenger train, except as provided in Rule 333 or by train order.

A train may be permitted to follow a train other than a passenger train into a block under permissive indication or Clearance Form A.

319. When a train enters a block, the signalman must give train number and time to the next block station in advance. When the rear of the train has passed 250 feet beyond the block signal, he must give the record of the train to the next block station in the rear. This information must be entered on the block records.

320. Unless otherwise provided, signalmen must not ask for the block until they have received a report of the train from the next block station in the rear.

321. Signalmen must, as far as practicable, observe all passing trains and note whether they are complete and in order, and the markers properly displayed.

322. Should a train pass a block station with any indication of conditions endangering the train, or a train on another track, the signalman must immediately notify the signalman at the next block station in advance, and each must display Stop-indications to all trains that may be affected, and must not permit any train to proceed until it is known that its track is not obstructed.

325. A signalman informed of any obstruction in a block must immediately notify the signalman at the other end of the block and each must display Stop-indications to all trains that may be affected and must not permit any train to proceed until it is known that its track is not obstructed.

326. When a train or engine takes a siding or otherwise clears the main track the signalman must know that it is clear of the block before giving "2" or displaying a Clear-indication for that block.

The signalman must obtain control of the block before permitting a train or engine to re-enter the block.

327. To permit a train or engine to enter a block or foul the main track, or to cross from one main track to another, the signalman must examine the block record, and if all the blocks affected are clear of approaching trains he must provide or arrange for block protection before permission is given, and until movement is complete and the block clear, trains will not be admitted to the block except as prescribed by Rule 300 B or Clearance Form A.

All cross-over movements must be entered on the block record.

328. When coupled trains are separated, as prescribed by Rule 364, the signalman must regard each portion as an independent train.

329. When necessary to stop a train for which other than a Stop-indication has been displayed and accepted, the signalman must give hand signals in addition to displaying the Stop-indication.

333. When, from any cause, a signalman is unable to communicate with the next block station in advance, he must stop all trains approaching in that direction. Should no cause for detaining a train be known, it may then be permitted to proceed with Clearance Form A, provided ten minutes have elapsed since the passage of the last preceding train.

334. Hand signals must not be used when the proper indication can be displayed by the block signals, except as prescribed by Rule 329 or 343. When hand signals are necessary they must be given from such a place and in such a way that there can be no misunderstanding on the part of engine men or trainmen as to the signals, or as to the train or engine for which they are intended.

Note.—Hand signaling includes the use of flag, lamp, torpedo and fusee signals.

335. Block signals for a track apply only to trains moving with the current of traffic on that track. Signalmen will use train order or home signal for blocking trains moving against the current of traffic.

336. Signalmen are responsible for the care of the block station, lamps and supplies; and, unless otherwise provided, of the signal apparatus.

337. Lights in block stations must be so placed that they cannot be seen from approaching trains.

339. If a Stop-indication is disregarded, the fact must be reported to the next block station in advance and then to train dispatcher.

340. To open a block station, the signalman must give "38" to the next block station in each direction and record the trains that are in the extended block.

When trains, which were in the extended block when the block station was opened and which had passed his block station before it was opened, clear the block in advance he must repeat the record to the block station in the rear.

341. A block station must not be closed except upon authority of train dispatcher.

342. Unless otherwise provided, a block station must not be closed until the block in each direction is clear of all trains.

To close a block station, the signalman must give 39 followed by 2 to the next block station in each direction and when he receives 13 followed by 2 enter it on his block record, with the time it is received from each block station.

The block signals must then be secured in the proceed position, all lights extinguished, and the block wires and, when necessary, circuits arranged to work through the closed block station.

343. When a block station is open at an irregular hour, signalmen must use hand signals, in addition to block signals, to give the required indications until all trains have passed which have not been notified by train order that the block station is open.

343 (A). When weather conditions obscure the view, operators will promptly report to the train dispatcher, who will decide if an absolute block of all trains must be maintained.

344. Signalmen must not permit unauthorized persons to enter the block station.

#### ENGINE AND TRAIN CREWS.

361. Block signals for a track apply only to trains moving with the current of traffic on that track.

Train order or home signal will be used for blocking trains moving against the current of traffic.

362. Trains must not pass a Stop-indication without receiving Clearance Form A.

362 (A). Where train order signal is also used as block signal, a train may pass such signal at Stop-indication to make a station stop, to take fuel or water, or to enter the siding in advance of the signal, provided the track is known to be clear, and under protection as prescribed by Rule 99Y

363. Trains must not proceed on hand signals as against block signals.

364. Unless otherwise directed, when two or more trains have been coupled and so move past any block station, they must be separated only at a block station and the signalman notified.

365. When a train or engine takes a siding or otherwise clears the main track, unless the switch involved is operated by the signalman, conductor or engineman must report to the signalman. A train or engine must not enter a block or foul the main track, or cross from one main track to another, without permission of the signalman.

A train or engine having passed beyond the limits of a block must not back into that block without permission of the signalman.

365 (A). Where Rule 317 is in effect, trains must not go to a closed block station or a siding between two open block stations to meet a train or trains without a train order, and in addition will receive Clearance Form A at the nearest open block station reading "Block clear except ..... Stop-indication is displayed for ..... to meet ..... as per Order No. ...".

365 (B). Where Rule 317 is in effect, trains must not go to a closed block station or a siding between two open block stations to be passed by other trains without a train order.

370. When there is an obstruction between block stations, notice must be given to the nearest signalman.

371. When a train is stopped by a home or block signal, the conductor or engineman must, when practicable, immediately ascertain the cause.

372. Conductors must report to superintendent any unusual detention at block stations.

373. A block station must not be considered as closed, except as provided for by time-table or special instructions.

373 (A). When a train receives a Clearance Form A filled out as shown in Rule 317 (B), it must not leave that station before the opposing train mentioned in the clearance has arrived.

AUTOMATIC BLOCK SIGNALS.

501 A

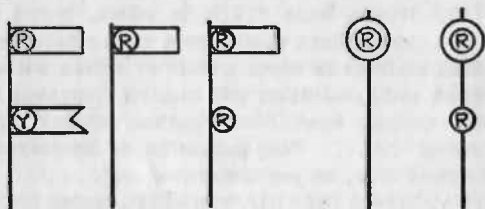

Indication—Stop.  
Name—Stop signal.  
See Rule 509 A.

501 AA

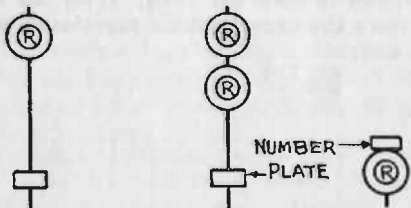
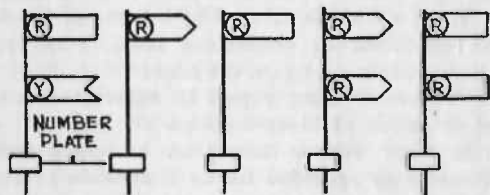

Indication—Stop, then proceed at restricted speed.  
Name—Stop and proceed signal.  
See Rule 509 B.

501 AAA

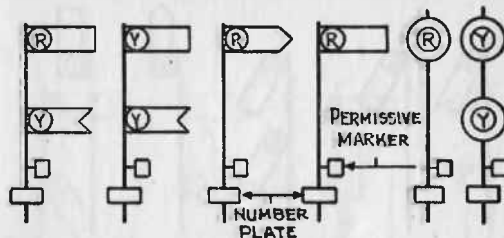

Indication—Proceed at restricted speed without stopping.  
Name—Permissive signal.  
See Rule 509 C.

501 B

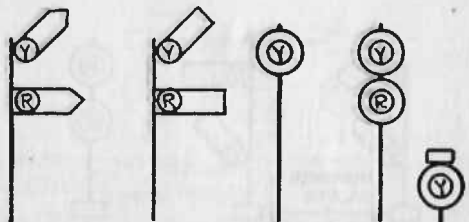
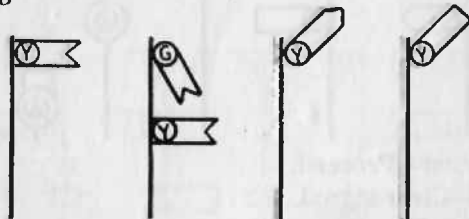

Indication—Proceed preparing to stop at next signal. Train exceeding medium speed must at once reduce to that speed.  
Name—Approach signal.

501 C

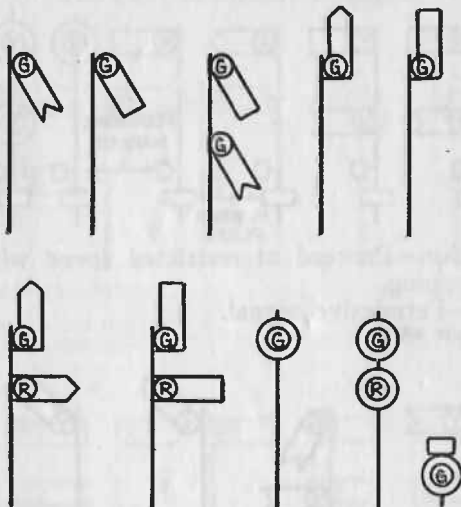

Indication—Proceed.  
Name—Clear signal.  
See Rule 519.

501 D

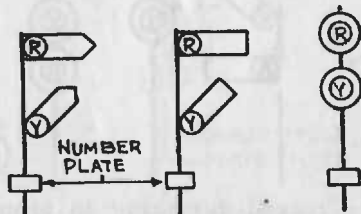

Indication—Proceed at slow speed on diverging route.  
Name—Approach diverging route signal.

501 E

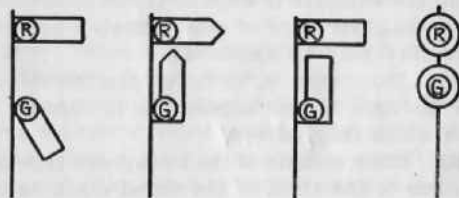

Indication—Proceed on diverging route.  
Name—Clear diverging route signal.

501 F

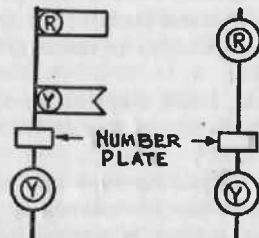

Indication—Proceed to train-order signal at restricted speed.  
Name—Train order approach signal.

## AUTOMATIC BLOCK SYSTEM RULES.

505. Block signals, cab signals, or both, govern the use of blocks, but, unless otherwise provided, do not supersede the superiority of trains; nor dispense with the use or the observance of other signals whenever and wherever they may be required.

506 (A). Block signals, as far as practicable, are located to the right of and adjacent to or directly above the track which they govern.

506 (B). Block signals of the semaphore type display arm or arms to the right of the signal mast, as viewed from an approaching train, and in addition display lights of the prescribed color as required.

506 (C). Block signals of the color light type, display their indication by lights of prescribed color, as viewed from an approaching train.

506 (D). The absence of a light, or a white light displayed where a colored light should be, on a block signal, must be regarded as the most restrictive indication that can be given by that signal, except that when the day indication is plainly seen it will govern.

508 (A). On any track signaled for traffic in both directions, block signals apply to trains in the direction of their movement.

508 (B). On any track signaled for traffic in one direction, block signals apply only to trains moving with the current of traffic.

508 (C). Stop signals have no number plates. Stop and proceed signals are designated by number plates.

509 (A). When a train is stopped by a Stop-indication it must stay until authorized to proceed, and will then proceed at restricted speed, or in case of failure of means of communication it may proceed when preceded by a flagman to the next signal displaying a proceed indication.

When the signal does not clear and the train dispatcher knows there is no opposing train movement in-

volved, he may authorize the train to proceed at restricted speed. If the train dispatcher does not positively know there is no opposing train movement involved, the train may proceed when preceded by a flagman.

509 (B). When a train is stopped by a stop and proceed indication, it may proceed:

(a) On any track signaled for traffic in both directions at restricted speed through the entire block, except that when a train is proceeding under protection of a flagman from the last Stop-indication, it must continue under protection of a flagman to the next signal displaying a "Proceed" indication.

(b) On any track signaled for traffic in one direction, at once at restricted speed through the entire block.

509 (C). When a train approaches an automatic block signal equipped with a permissive marker and displaying the Stop-indication, it may pass the signal at restricted speed without stopping.

510. When a train is stopped by a block signal which is evidently out of order, unless otherwise provided, the fact must be reported to the train dispatcher.

510 (A). When stopping at a signal, the leading wheels should not pass the signal.

511. Both switches of a cross-over must be open before a train or engine starts to make a cross-over movement, and the movement must be completed before either switch is restored to normal position.

512. Where switch indicators are used, the indications displayed do not relieve enginemen and trainmen from protecting their train as required by the rules.

513. Unless otherwise provided, before a train or engine enters on or fouls a main track, or crosses from one main track to another, at bolt-locked switches, after operating the bolt-lock, the trainmen must wait two minutes before operating the switch; at non-bolt-

locked switches trainmen will operate the switch and wait two minutes at the switch before making engine or train movement; except that if it is immediately after an opposing train has passed the switch the movement may be made immediately. This will not relieve employes from the duty of promptly and properly protecting the movement.

514. A train or engine entering a block between signals must be protected as required by the rules and must proceed at restricted speed.

514 (A). A train or engine or cars on sidings or other tracks must stand clear of insulated joints placed in the track at the clearance point.

When a train or engine enters a siding or other track, the main track switch shall be kept open until the entire train has passed the insulated joints at the clearance point.

Trains or engines proceeding from sidings or other tracks, to the main track, must remain clear of the insulated joints at the clearance point on such tracks until the main track switch has been opened.

515. A train or engine having passed beyond the limits of a block, must not back into that block, except under protection as prescribed by Rule 99 or train order.

516. A train which is to take siding at a point where the switch to be used is within 300 feet in advance of an automatic block signal, may pass such signal at stop to enter siding at restricted speed, provided the switch is set for the siding and the way is known to be clear.

517. In foggy or stormy weather, enginemen must approach all signals with great care, prepared to respect the indication given.

518. Light weight motor trains of two cars or less, must not be allowed to stand on sanded rails.

519. After passing a signal displaying a proceed indication the indication of the next signal may change to stop, and engineman and trainman must be on the alert to observe it.

## INTERLOCKING SIGNALS.

601 A

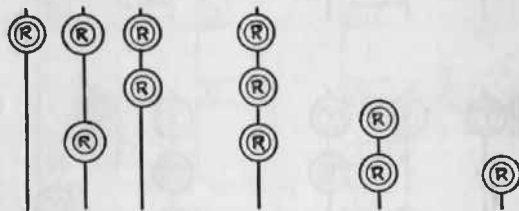
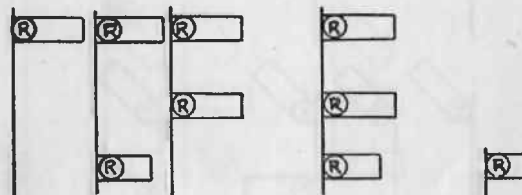

Indication—Stop.  
Name—Stop signal.



601 B

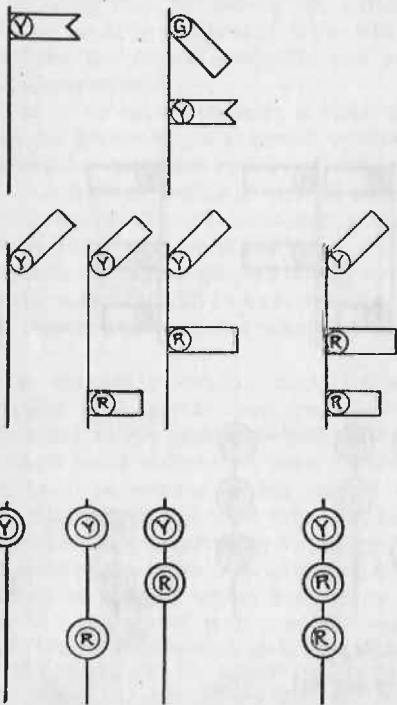

Indication—Proceed, preparing to stop at next signal. Train exceeding medium speed must at once reduce to that speed.

Name—Approach signal.

601 C

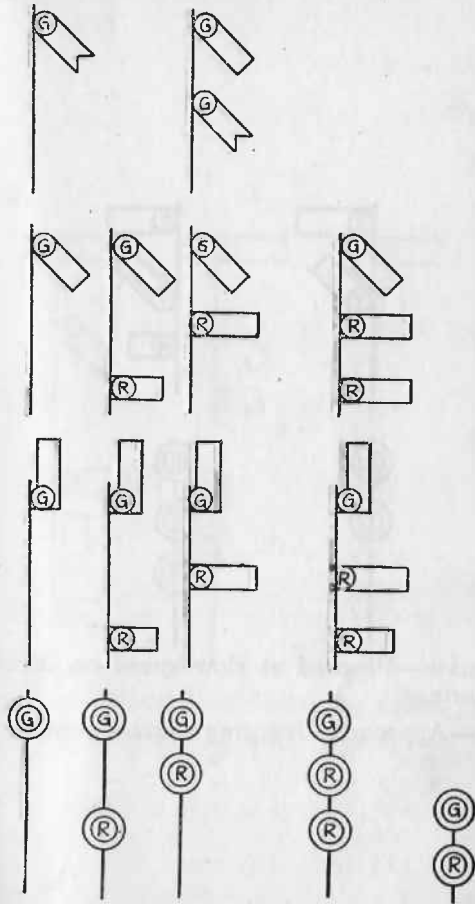

Indication—Proceed.  
Name—Clear signal.  
See Rule 519.

601 D

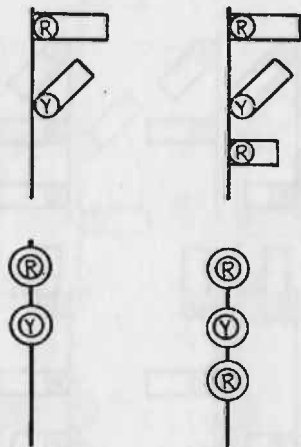

Indication—Proceed at slow speed on diverging route.

Name—Approach diverging route signal.

601 E

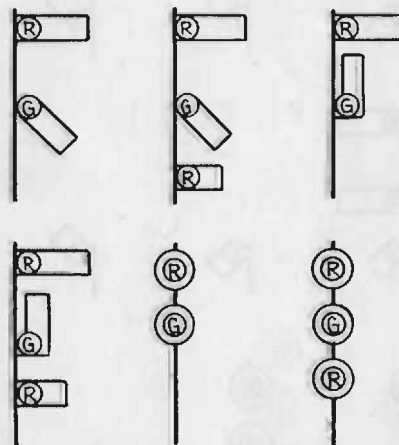

Indication—Proceed on diverging route.

Name—Clear diverging route signal.

601 F

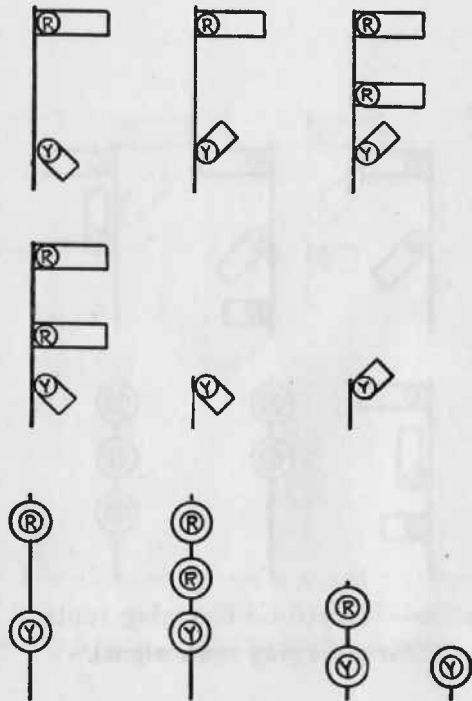

Indication—Proceed at restricted speed.  
Name—Restricting signal.

601 G

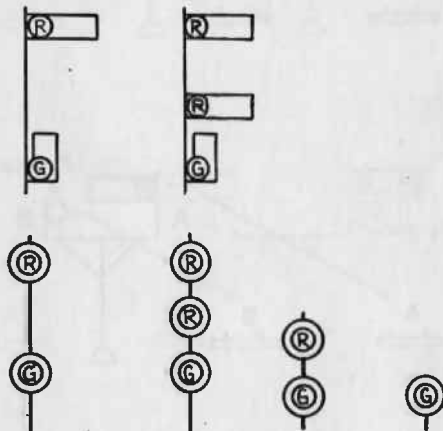

Indication—Proceed at slow speed.  
Name—Slow-clear signal.

SIGNALS ON BRACKET MAST.

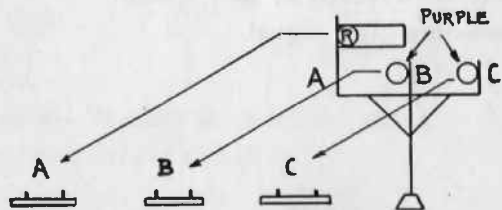
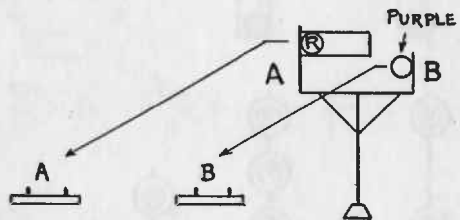
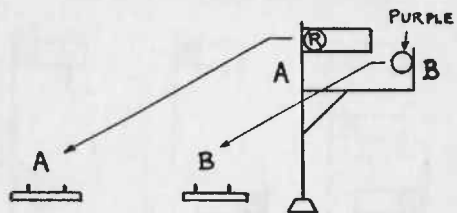

SIGNALS ON BRACKET MAST

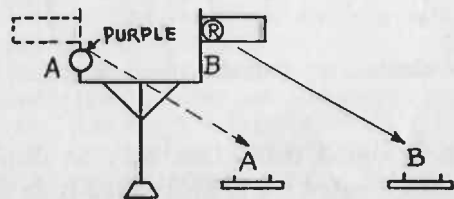
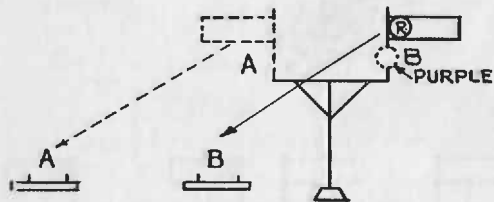
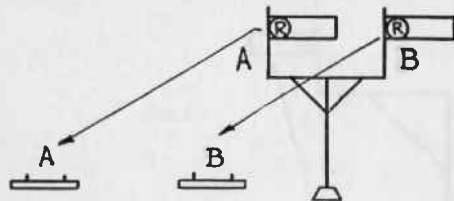

## SIGNALS ON CANTILEVER MAST OR BRIDGE.

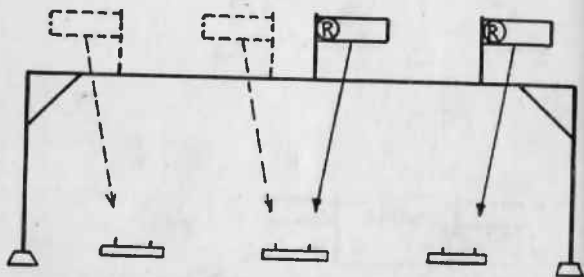
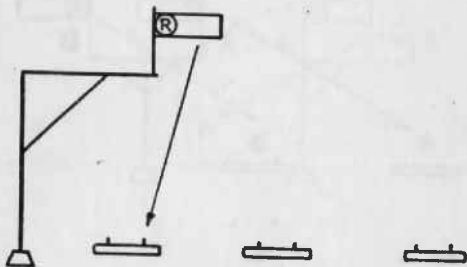

Standard signal indications may be displayed by signals mounted on, or suspended from bracket, or cantilever mast or signal bridge when track arrangement or other condition requires their use.

## SMASH-BOARDS.

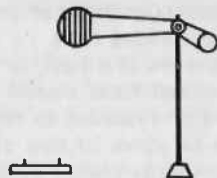

Normal position.

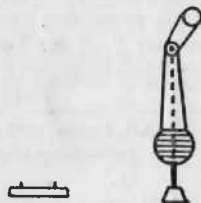

Reverse position.

Smash-board in reverse position does not supersede signal indication.

## INTERLOCKING RULES.

605. Interlocking signals govern the use of the routes of an interlocking, and as to movements within home signal limits their indications supersede the superiority of trains, but do not dispense with the use or the observance of other signals whenever and wherever they may be required.

605 (A). Interlocking signals, as far as practicable, are located to the right and adjacent to or directly above the track which they govern.

605 (B). Interlocking signals of the semaphore type display semaphore arm or arms to the right of the signal mast, as viewed from an approaching train, and in addition display lights of prescribed color as required.

605 (C). Interlocking signals of the color light type, display their indication by lights of prescribed color, as viewed from an approaching train.

605 (D). The absence of a light, or a white light displayed where a colored light should be, on an interlocking signal, must be regarded as the most restrictive indication that can be given by that signal, except that when the day indication is plainly seen it will govern.

#### 606. EMERGENCY SIGNALS.

(Whistle or Horn.)

Note.—The signals prescribed are illustrated by "o" for short sounds; "—" for longer sounds.

Sound.	Indication.
(a) —————	All trains and engines within interlocking limits stop immediately.
(b) o o	Resume normal movement after receiving the proper signal or permission from the signalman.
(c) o o o	Whistle or horn test.
(d) o o o o	Call signal maintainer or repairman.

607. Unless otherwise provided, interlocking signals located in automatic block signal territory, are a part of the automatic block signal system.

#### SIGNALMEN.

611. Unless otherwise provided, interlocking signals must be kept in the position displaying the most restrictive indication, except when displayed for an immediate movement.

612. Appliances must be operated carefully and only by those charged with that duty. If any irregularity affecting their operation is detected, the signals must be displayed to give their most restrictive indication until repairs are made.

613. When the route is set the signals must be operated sufficiently in advance of approaching trains to avoid delay.

614. Unless otherwise provided, a signal must be restored so as to display the most restrictive indication as soon as the train or engine for which it was cleared, has passed it.

615. When necessary to change any route for which the signals have been cleared for an approaching train or engine, switches, movable point frogs or derails, must not be changed or signals cleared for a conflicting route until the train or engine for which the signals were first cleared has stopped.

616. The lever operating a switch, derail, movable point frog, detector bar or lock must not be moved when any portion of a train or engine is standing on or closely approaching the switch, derail or movable point frog.

617. Operating levers must be blocked or marked and should not be used when a track, switch or signal is undergoing repairs or when a track is obstructed.

618. During cold weather, the levers must be moved as often as may be necessary to keep connections from freezing.

619. If the force whose duty it is to keep switches clear when snow or sand is drifting, is not on hand when required, the fact must be reported to the superintendent.

620. If a signal fails to work properly, its operation must be discontinued and until repaired the signal secured so as to display its most restrictive indication.

621. Signalmen must observe, as far as practicable, whether the indications of the signals correspond with the position of the levers.

622. Signalmen must not make nor permit any unauthorized repairs, alterations or additions to the interlocking.

Any defects in the interlocking must be promptly reported to the superintendent.

623. If there is a derailment or if a switch, movable point frog or derail is run through, or if any damage occurs to the track or interlocking, the signals must be restored so as to display their most restrictive indication, and no movement permitted until all parts of the interlocking and track liable to consequent damage have been examined and are known to be in a safe condition.

624. When necessary to disconnect a switch, movable point frog, derail, facing point lock, detector bar or electric locking circuits, all switches, movable point frogs and derails affected must be securely spiked or fastened in the required position and the levers blocked or marked in such a manner that they cannot be operated, before any train or engine is permitted to pass over them.

625. When switches, movable point frogs, derails or signals are undergoing repairs, Stop-indication must be displayed for any movement which may be affected by such repairs, until it has been ascertained from the repairman that the switches, movable point frogs and derails are properly lined for such movement.

626. Signalmen must, as far as practicable, observe all passing trains and note whether they are complete and in order; should there be any indication of conditions endangering the train, or any other train, the signalman must take such measures for the protection of trains as may be practicable.

628. Signalman must not give hand signals when the proper indication can be displayed by the interlocking signals. Hand signals must not be given until the route has been examined, is known to be safe for the passage of train, and until after the train comes to a stop at the Home Signal. Signalman will then give hand signal, using a yellow flag by day and yellow light by night from the center of the track on which the train move-

ment is to be made. When more than one train is in sight and confusion may result, hand signal must be given from a point where it cannot be misunderstood.

629. If necessary to pass any interlocking signal indicating stop, hand signals must be used and the superintendent notified.

630. Signalmen are responsible for the care of the interlocking station, lamps and supplies.

631. Lights in interlocking stations must be so placed that they cannot be seen from approaching trains.

633. If a train or engine overruns a Stop-indication, the fact must be reported to the superintendent.

634. Signalmen must not permit unauthorized persons to enter the interlocking station.

635. During a stated period, an interlocking station may be closed upon authority of the superintendent. When so closed, switches and switch levers must be secured for routes that do not conflict, and signal levers placed in position so that signals will display the proper indication.

The interlocking station must be securely locked.

636. At interlocking stations where there is a train order or block signal operated by the same signalman, such signals must not be changed to display a proceed indication for a train until after the interlocking signal has been changed to permit the train to proceed.

637. When it is safe to do so, switches and signals may be operated on the request of section men, signalmen, or inspectors.

#### ENGINE AND TRAIN CREWS.

661. If a signal indication, permitting a train or engine to proceed, after being accepted, is changed to a Stop-indication before it is reached, the stop must be made at once. Such occurrence must be reported to the superintendent.



663. When a train or engine is stopped by an interlocking Stop-indication, it may proceed at restricted speed after receiving a hand signal from the signalman given with a yellow flag by day and a yellow light by night, from the center of the track on which the movement is to be made. When more than one train is in sight and confusion may result, hand signal must be given from a point where it cannot be misunderstood.

663 (A). Unless otherwise provided, in automatic block signal territory, when a train or engine has moved through the interlocking limits either on hand signals or preceded by a flagman, it must proceed in accordance with Rule 509 (B).

667. Sand must not be used nor water allowed to run over the movable parts of an interlocking or spring switch.

668. A train or engine approaching a signal displaying a Stop-indication shall stop before the leading wheels pass the signal.

669. Trains or engines stopped by the signalman in making a movement through an interlocking must not move in either direction until they have received the proper signal from him.

670. A reverse movement within the limits of an interlocking, or a forward movement after making a reverse movement, must not be made without the proper interlocking signal indication or permission from the signalman.

671. While an interlocking station is closed, should a signal for an open route indicate "stop", movements through the interlocking must be preceded by a flagman. Before proceeding, the engineman and trainmen must know the route is properly lined.

In addition, if the interlocking governs movement over a drawbridge, engineman or trainmen must ascertain if bridge is in proper position for passage of a train.

The facts must be reported to the superintendent from the first available point of communication.

672. When a train or engine is stopped by the Stop-indication of an automatic interlocking signal, and no immediate conflicting train movement is evident, a trainman shall proceed to the crossing and operate "Release". If the signal does not change its indication at expiration of time interval, the trainman may signal his train to proceed over the crossing if there is no train or engine approaching on conflicting routes. If a train or engine is standing between the home signals on a conflicting route, the proceed signal must not be given until after a thorough understanding has been had with the crew of the train or engine on the conflicting route.

Trains or engines operating through automatic interlocking are governed by Automatic Block Signal Rules 505 to 519 inclusive, and Interlocking Rules 601 to 607 inclusive, and 661 to 672 inclusive.

#### GENERAL REGULATIONS.

701. Employes must be alert and devote themselves exclusively to the company's service, attend to their duties during the hours prescribed, reside where required, and comply with the instructions from the proper authority in matters pertaining to their respective branches of the service. They must not absent themselves from duty, exchange duties with, or substitute others in their place, nor engage in other business without proper authority.

Carelessness of a person's own safety or that of others is prohibited.

The reading of newspapers, books or periodicals or the playing of games by engine men, trainmen or yardmen, while on duty, is prohibited.

702. Civil, gentlemanly deportment is required of all employes in their dealings with the public, their sub-

ordinates, and each other. Courtesy and attention to patrons is demanded.

All employes are prohibited from entering into altercation with any person regardless of provocation. They will make a note of the facts, if necessary, and report to their immediate superior.

Employes must refrain from loud talking or the use of profane or vulgar language at stations or on or about trains.

703. Employes must not give information respecting the affairs of the railroad except to authorized officers, and must not permit unauthorized persons to have access to the books, waybills or other statistics in their charge.

704. Employes must exercise care and economy in the use of railroad property, and when leaving the service, or upon demand by proper authority, must return property intrusted to their care.

705. Employes are forbidden to make charge for services performed in line of duty, or to permit discrimination, and unless specially authorized, must not use the railroad's credit and must neither receive nor pay out money on the railroad account. Property of the railroad must not be sold nor in any way disposed of without proper authority. All articles of value found on railroad property must be cared for and promptly reported.

706. The telegraph or telephone must not be used when mail will answer the purpose. Messages must be briefly worded and confined to railroad business.

Letters of a personal nature must not be sent by railroad mail.

707. Alteration in the arrangement or design of structures, cars, or other railroad property is prohibited, except by proper authority.

708. No person will be permitted to ride on an engine, or in a baggage, mail, or express car, or on track cars (except employes in discharge of their duties), without a written order from the proper authority.

709. Railroad premises must be kept in neat, clean and orderly condition.

710. Before stopping for meals, trainmen and engine men must notify the train dispatcher sufficiently in advance to avoid delays to trains.

711. Passengers will not be carried on freight trains except as authorized by time-table or Special Instructions, or as otherwise authorized. Trainmen must warn passengers about the liability of injury in starting and stopping and request they remain seated while train is moving.

712. Employes must observe rules for other classes of employes that relate in any way to the proper discharge of their own duties or the safety of operation.

713. Employes must familiarize themselves with the Interstate Commerce Commission regulations governing the handling and transportation of explosives and inflammables and be governed thereby.

714. Employes must, so far as practicable, observe passing trains for defects. Should there be any indication of conditions endangering the train, they must take such measures for its protection as may be practicable.

Trainmen of freight and passenger trains, also yardmen, must observe passing trains for defects, such as brakes sticking, brake rigging down, swinging doors, hot journals and protruding objects, and will signal crews of such trains, calling attention to dangerous condition by signals shown below. If nothing irregular is noted, they will give proceed signals to the rear of the passing train.

When passing other trains and interlocking, block, water, coal or other stations, and points where trackmen or bridgemen are working, train and engine crews on moving trains must be on the lookout for signals, and, when practicable, exchange signals. If unable to communicate signals, the train dispatcher should be notified as quickly as possible of defective conditions.

The following signals will be used:

Hot journal.	}	By Day—Nose held with one hand and the other hand pointed toward passing train.
		By Night—Lamp swung vertically in a small circle; lamp to be held by guard wire around globe.
Brakes sticking.	}	By Day—Hands shoved in sliding motion out from body.
		By Night—Same signal given with lamp in hand.
Broken wheels. Defective truck. Dragging brake connection. Lading shifted over side or end of car. Swinging car door or any other dangerous condition.	}	Stop signal.

715. Employes must not remain near the track when trains are passing, as coal, stone, car doors, or other articles are liable to fall from the train. On two or more tracks, employes must stand outside and clear of tracks while trains are passing. Employes are further warned that they must not rely on others to notify them of the approach of a train.

716. Turn-tables not under immediate supervision of an employe must be kept locked.

717. When persons who are evidently intoxicated, idiotic, or insane, are seen in the vicinity of tracks they should be guarded from approaching trains.

718. Whenever passengers or employes are injured, everything possible must be done to care for them properly. If they are able to be moved, they must be taken for treatment to the nearest place at which the company has a surgeon. If the case is urgent and the

company surgeon cannot be immediately procured, the conductor, agent or officer in charge is authorized to call the nearest surgeon available to administer first aid and care for the patient until the company surgeon can take charge of the case.

719. In cases of serious accidents to trains, conductors, after making everything safe, must give their undivided attention to the care and comfort of their passengers, especially to those who are injured.

Bedding and linen may be taken from sleepers for this purpose, the conductor arranging with sleeping car employes to keep account of all material so taken. When necessary, injured persons may be put in the sleepers.

When a number of persons are injured, the services of competent surgeons, preferably company surgeons, in the vicinity should be secured at once.

720. In cases where trespassers or others are found injured on company property, the injured person or persons must be taken to the nearest station and either placed in the care of relatives or friends, or in the charge of the local county, city, or village authorities. Necessary medical aid should be arranged for injured person or persons, but with the distinct understanding that no expense therefor will be incurred by the company without specific authority from either the superintendent or the general claim department.

Where trespasser or other person is killed away from a station, or a corpse is found on the tracks, the body should be moved so as to give clear passage for trains. The coroner of the county in which the body is found must be notified promptly and facts reported by wire to the superintendent.

721. A report of all accidents must be made, and immediately sent by wire to superintendent, giving all information. Quick action is especially imperative in cases of serious injury and particularly so in connection

with accidents to passenger trains wherein any passengers thereon are injured.

Conductors in charge of passenger trains should be supplied at all times with supply of prescribed forms for taking names of passengers on trains derailed or in collision. One of these forms should be completely filled out for each passenger on train whether or not passenger claims injury, and passenger then requested to sign the form. If conductor's duties immediately following the accident are such as to prevent his obtaining these, he should delegate brakeman or some other available employe on train to procure them. These should be turned over to the claim agent, as soon as he boards train, or to the superintendent at destination, if not picked up by the claim agent.

722. In cases where automobiles or other vehicles or pedestrians are struck on railway tracks, either at crossing or elsewhere, the conductor, assisted by his brakemen, must, immediately after accident occurs, secure the names, addresses and occupations of all persons involved, including all persons at or arriving at the crossing soon after the accident; the license numbers of all cars nearby, whether or not these persons admit knowing anything about the accident. This information should be included in reports made covering the occurrence. Where automatic signaling devices are provided or watchmen or flagmen are on duty, a special effort should be made to determine who, among the witnesses, can testify that the apparatus was properly functioning or the crossing flagman or watchman properly performing his duty. The same is true with respect to witnesses who can testify regarding whistle and bell signals.

723. In cases where persons or vehicles are struck and injured or damaged by trains or locomotives on crossings in the vicinity of stations, agent at point where accident occurred will immediately locate on a

rough sketch and show by actual measurement the position of all cars standing on tracks at or near the crossing, and send report to the superintendent, describing the cars, giving the initials and number of each and their location with reference to the crossing where the accident occurred.

724. All equipment such as cars, engines, machinery or tools, etc., also premises involved in accidents resulting in personal injuries should be promptly inspected by the foreman or other person in charge of the work or by other competent inspectors to ascertain the condition of same. A report of such inspection stating the conditions found and name or names of the persons making the inspection should be promptly forwarded to the superior officer of the person making the inspection.

When tools, machinery or other types of equipment or appliances are involved in an accident resulting in personal injury, they should, if at all possible, be marked for identification and placed in custody of some responsible officer or employe and held subject to the order of the general claim department or the superintendent, regardless of whether or not inspection reveals any defect therein.

725. When engines, cars or other rolling stock are involved in an accident resulting in personal injury, such inspection as can be made should be made before such equipment leaves the place of accident, and this should be followed by a further inspection at the first terminal. Such inspection should be made by at least two competent employes, preferably by car inspector, car foreman or master mechanic. Report of the result of such inspection should be promptly forwarded through the proper channels to the superintendent and by him transmitted to the general claim department.

726. A yellow flag or disc by day, and in addition a yellow light by night, placed on the engineman's side of the track, indicates that the track one mile distant is

in condition for a speed of not more than ten miles per hour, unless a different speed is specified by train order, bulletin, or Special Rule. A green flag or disc by day, and in addition, a green light by night, placed on the engineman's side of the track, indicates that the slow track has been passed. The entire train must pass over the designated territory at the speed required, and the flagman will give proceed signal when the rear of train has passed the green signal.

727. When a red flag or a red light is found between the rails of the track, or on the engineman's side of the track, the train must stop and not proceed until proper information is obtained.

728. If track is found or is to be made impassable, flagman must be sent out in both directions. At a distance fifty rail lengths from the obstruction, the flagman must place a red flag by day and, in addition, a red light at night on engineman's side. Two torpedoes must be placed ten rail lengths beyond the red signal. A yellow flag by day and, in addition, a yellow light by night must be placed one mile beyond the red signal where they can be plainly seen by an approaching train. Two torpedoes must be placed ten rail lengths beyond the yellow signal or farther on descending grades or where the view is obscured. Flagman will then return to a point near the "stop" signal remaining there until relieved or recalled by his foreman. On the approach of a train, flagman will give "stop" signal. Trains stopped by these signals must be governed by signal or instructions from the foreman in charge who, in giving such signal, must use a yellow flag by day or a yellow light by night.

On two or more tracks, the required protection must be provided in both directions on the obstructed track.

#### TRAIN AND YARD SERVICE.

801. In switching, where it is necessary to disturb cars that are being loaded or unloaded, notice must first be given to all persons in or about the cars that are to

be moved. When cars are so moved, they must be replaced and their hand brakes set. Public highway crossings must not be blocked longer than necessary. A clear passageway must be left to the station.

Before moving cars or engines in a street, or on station or yard tracks, it must be known that the cars can be moved with safety.

When switching at stations or in yards where engines may be working at both ends of the track, movements must be made carefully and an understanding had with other crews involved to guard against accidents.

When switching or placing cars, employes must know that they are not left standing so close as to not fully clear passing cars on adjacent tracks or cause injury to employes riding on the side of cars.

802. In leaving cars on side tracks, they must be left clear of street, highway or private crossings and as far back from the crossing as practicable.

Cars must not be left on sidings except in case of emergency, and the train dispatcher immediately notified. Cars must be held by hand brakes, and if necessary, in addition, the wheels must be blocked.

Cars stored on isolated tracks should be separated into cuts of ten cars each, one hundred feet apart.

803. When switching, it must be known that brakes are in good order before cutting off cars. Running switches are prohibited except when they can be made without danger to employes, equipment or contents of cars. It must be known that the switches and brakes are in working order before making the switch, and the engine must be run on straight track when practicable. Running switches must not be made with cars containing explosives or inflammables.

804. Switches must be set for the dead rails over track scales when the scales are not in use.

805. When handling cars containing explosives or inflammables it should be known that they are in the proper place in the train, and when handling special

equipment such as boom cars, pile drivers, etc., it should be known that they are in the proper place in the train, boom properly secured and trailing when practicable, and the engineman notified.

806. When it is necessary to move occupied outfit cars, if there are women or children with those cars whom it is not practicable to move in any other way, they may remain in the outfit car during such movement when requested by foreman or authorized by the superintendent. When there is a place provided for passengers, they should ride therein.

Occupied outfit cars should be handled immediately ahead of the caboose, when practicable.

When moving men to and from work in cars, the cars should be pulled instead of being pushed, if practicable.

807. When occupied outfit cars are set out or when taken into yard in trains, the train dispatcher and the yard master must be promptly notified. Sidings blocked by occupied outfit cars should not be used for meeting or passing trains if it can be avoided.

808. When approaching and passing through stations or yards, or passing over railroad crossings, drawbridges, track covered by slow orders, or on long descending grades, and other places where safety requires, conductors and brakemen must, when practicable, station themselves where they can observe and transmit signals and assist in stopping train, if necessary.

809. In case of damage to trains or structures wherein the security of company property or freight is involved, watchmen must be immediately stationed and arrangements made promptly for the protection of such property against theft, or loss from other causes.

810. Trainmen and engine men must report the presence of fires on or near the right of way to the superintendent at the first opportunity unless the fire is being controlled by other employes. In case a fire may

be communicated to a bridge, or other structure, they must stop and assist in extinguishing the fire.

The conductor will call the attention of his engine men promptly to fires that may have been started by his engine, and request an inspection of the fire prevention appliances.

811. When practicable, occupied outfit cars should not be placed adjacent to or in buildings or structures. In case of fire in a car containing passengers, caretakers or employes, the train must be stopped at once, occupants immediately removed from such car or other cars which may be threatened and prevented from re-entering same; every effort must then be made to extinguish the fire.

If, after all occupants and others have been removed to safety, it is then found to be impossible to extinguish the fire at the point where the train is stopped, the conductor will, if advisable, and if it can be done with safety, move train, cars or car to the nearest available point where assistance is obtainable.

It is important that the cause of fire be ascertained in each case and promptly reported.

812. In departing from stations, and at every opportunity on the road, trainmen must carefully inspect their trains for possible defects of the running gear, brake and draft rigging, giving special attention to hot journals, sticking brakes, and sliding wheels. If train is moving when defect is discovered, signal should be given to the engineman to stop. If possible, defects should be remedied, but if this cannot be done and if car is unsafe to run, it should be set out and the train dispatcher notified.

In starting freight trains, the speed for the first train length should be such as will permit full inspection by the train crew, and permit them to safely board the train.

813. Caution and good judgment must be exercised

in starting and stopping trains to avoid sudden movements which might cause discomfort or injury to passengers or damage to property.

Conductors should call the attention of enginemen to any rough handling as soon as the information can be given, and will make prompt report to the superintendent of any improper handling of trains.

814. Except as otherwise provided, instructions contained in the current air brake instruction book covering operation and maintenance of air brake and air signal apparatus will govern, and employes having to do with air brake operation must provide themselves with a copy and be prepared to pass a satisfactory examination on all rules pertaining to their duties.

815. Each train must have the air brakes on all cars in effective operating condition, except in case of emergency, but at no time shall the number of operative brakes be less than permitted by Federal requirements. Cars with inoperative air brakes must be placed behind cars with operative brakes; and must not be intermingled with power brake cars controlled by the engine-man. Should an air brake become defective in operation to the extent of having to be cut out after leaving a repair point, it may be hauled to the next repair point without being switched to the rear. There must be at least 85% of all cars in the train with the air brakes in effective operative condition. Each car having a defective air brake must be properly carded or reported on a prescribed form.

816. Trains must not leave terminals nor start from points where train line has been disconnected or an angle cock closed or crews changed, nor pass the summit or descend mountain grades until after the prescribed tests of the brakes have been made.

817. Should the air brakes on a train become ineffective, the engineman must notify the conductor at once and if they are so ineffective as to interfere with

proper control of train, a report must be made to the superintendent.

Passenger equipment or occupied outfit cars must not be switched without having the air brakes cut in and operative.

Passenger trains must not be backed without suitable back-up hose or its equivalent, and the conductor or other competent employe at the rear, and when such back-up hose is to be used, the brakes must be tested as prescribed by the air brake rules.

818. Trainmen must know by speed of train, grade, or caboose air gauge that train is being handled safely and under control, and, when necessary, take immediate action to get train under safe control.

#### YARDMASTERS.

840. At stations where a yardmaster is employed, the general direction and government of the yard is in his charge, and all persons employed in yard service must obey his instructions.

They must see that cars are carefully handled and no unnecessary noise made by engines or employes, giving particular attention to the work in connection with or near sleeping cars in service and see that the occupants are not unnecessarily disturbed.

841. Yardmasters are responsible for the proper make-up and movement of trains through yards, the prompt handling of cars and the requirements as to the diversion, refrigeration, ventilation and heating, and for the proper position and security of all yard switches. Main track switches, except when in use, must be locked for the main track.

#### TRAIN MEN.

850. The general direction and government of a train is in charge of the conductor and all persons employed on the train are subject to his instructions. Should there be any doubt as to authority or safety of proceed-



ing, from any cause, he will consult the engineman and shall be equally responsible with him for the safety and proper handling of the train, and for such use of signals and other precautions as the case may require. He must be vigilant and cautious; he must comply with the instructions of yardmasters within yard limits and be governed by the direction of agents in doing work at stations.

851. Conductors and other trainmen must report for duty at the appointed time, and, by personal attention, insure departure at the required time.

They must see that their trains are provided with proper tools and equipment at all times; know that the cars in their trains have been inspected, and that the brakes are in proper working order.

852. Conductors must see that their trainmen are familiar with and perform their duties, instruct them if necessary, and caution them as to its risks; see that they are conversant with and properly understand and comply with the rules and special instructions, particularly those relating to protection of trains. Disobedience and incompetency must be reported.

853. Conductors must expedite the handling of trains, performance of station work, and if necessary at night to avoid serious delay, call the day operator.

Trainmen must attend to the needs of those in charge as messengers with freight, livestock, etc., and see that they are given proper information as to stops for meals, change of cars, etc.

854. Trainmen on duty, when not engaged elsewhere, must occupy the posts assigned to them. They will also observe the position of all train order signals, be prepared to and pick up any messages or orders, keep a sharp lookout for signals displayed by other trains, and keep in mind all train orders and notices affecting the movement of trains so as to be prepared to call attention to or take necessary action in the event of any

oversight or mistake. The rear brakeman or flagman should be on the last car of the train, or in the car next ahead, and on passenger trains should get on and off at the openings between those cars. He must not, except when necessary, disturb the occupants, nor ride in the observation end of observation or special cars, except at times when that part of the car is not occupied.

#### PASSENGER SERVICE.

870. Hand baggage should not be placed in the aisles of passenger cars. Heavy hand baggage or bulky packages should not be placed in overhead racks where there is possible danger of falling. Train crews should supervise the stowing of baggage and see that it is accomplished in such a manner as to minimize hazard of accident to passengers.

871. Conductors must not permit intoxicated or disorderly persons to get on their trains, nor persons mentally incompetent unless accompanied by an attendant. They must not permit obscene or profane language, nor interference or annoyance of other passengers, or other misconduct.

872. Train employes must be on the lookout for confidence men and swindlers; have them watched, personally warn passengers, and if any attempt be made to defraud them, must prevent it and report the case by wire to the superintendent. They must not permit beggars or unauthorized peddlers to practice their vocations on the train, nor allow advertising matter to be distributed.

873. No person will be allowed to ride without proper transportation, and conductors must collect fare from all persons traveling without it.

874. When examining tickets, conductors must notify passengers destined to points reached by other trains, where they are to change cars; also where they will find

trains of such connections and notify passengers as to the approximate time.

Approaching and before leaving stations, junctions, lunch rooms and terminals, proper announcement necessary for the information and guidance of passengers must be made by trainmen.

Conductors will see that employes of sleeping and parlor cars advise their passengers when they are to leave the train.

875. As far as possible, conductors must see that passengers are provided with seats, and that no one is allowed to occupy more than a single seat to the exclusion of others. When there are not seats enough in the coaches and there are vacant seats in any parlor or sleeping car (except chartered cars), passengers may be seated therein and train conductors will arrange with parlor or sleeping car conductors accordingly. Such seats must be surrendered as soon as there is room in the coaches or whenever they are wanted for regular use. Seats in sleeping cars must not be so assigned or occupied at night after the regular passengers have retired.

876. Train employes must not occupy seats with passengers, nor enter into conversation with them or other employes further than is required in the discharge of their duty, but will give proper attention to the convenience and comfort of passengers, and give particular assistance to children who are unattended, and to persons who are ill, infirm, inexperienced, or otherwise unable to care for themselves.

877. If necessary to eject a passenger from a train, discretion must be used. Local rules, state laws and the conditions shall govern. Conductors will call upon local peace officers or upon railroad police for assistance when necessary.

If a passenger is ejected from the train, the name and addresses of all witnesses and their statements in

writing, if possible, should be obtained. Passengers must not be ejected except where shelter and food may be obtained.

If there is doubt as to the right of a passenger to continue on transportation presented, or as to the proper course to be pursued, the facts in the case must be reported by wire to the superintendent.

878. Articles found in trains should be labeled with train number, car number and name of finder, and upon arrival at terminal or junction station should be turned over to agent or baggageman and receipt secured.

879. When a conductor delivers a train to another conductor, he must inform him of any facts which it may be necessary or proper for the relieving conductor to know before taking charge. Care must be exercised to properly transfer transportation. Except as otherwise arranged, passenger trainmen will remain at their trains at terminals in uniform to answer inquiries and assist passengers until the train is vacated, or until they are relieved.

880. Conductors will see that all telegrams intrusted to their care are promptly delivered. If, for any reason, they cannot be delivered, conductors will write this fact upon the envelope and hand it off at the next open telegraph office.

881. Train employes must familiarize themselves with the instructions governing heating, lighting, ventilation and air conditioning of cars and see that the instructions are complied with, and that cars are properly supplied with water or ice and are kept clean.

882. Side doors and trap doors of vestibules must be kept closed when train is in motion except when necessary to check signals or inspect train. When a train is standing to meet or to be passed by another train at a point where no passengers are to be received or discharged, the vestibule doors must be kept closed on the side on which the approaching train is to move, un-

less a trainman is in position to prevent passengers from alighting.

When cuts are to be made between passenger cars while switching, trainmen must know that end gates, bars or chains are in proper position at the end of each car where cut is to be made.

When necessary to uncouple an electric-lighted train, the connector must be taken down and not left hanging.

Marker lamps should not be carried through business, dining, sleeping, observation or private cars, when it can be avoided.

Unnecessary noises in or about sleeping cars at night should be prevented so far as possible, and careless switching or coupling of cars avoided.

883. Gunpowder, dynamite, nitro-glycerine, or similar explosives must not be transported in any car attached to a passenger train. Motion picture films must not be carried in any car in which passengers are carried except when being transported as baggage or express in accordance with the provisions of Interstate Commerce Commission, Bureau of Safety regulations, or as United States Mail, as provided for in Postal Laws and Regulations.

884. Train employes should not pass through dining, sleeping or private cars except when necessary in the performance of duty, and when passing through dining cars during meal hours, or through private cars, train employes, other than the conductors when lifting tickets, will remove their caps.

885. Trains must not leave a station at which they are scheduled to receive U. S. mail until the loading has been completed. Trainmen will decline to accept pouches containing mail matter unless the pouches are properly locked. When trains are diverted from their regular track on which they usually pick up mail, arrangements must be made for getting that mail.

## FREIGHT SERVICE.

900. Conductors are responsible for the security of all freight carried by their trains while in their charge, and for its delivery, with the necessary waybills or manifests at its destination or at terminals.

The doors of empty cars in trains must be kept closed. The doors of loaded cars must be kept closed and properly secured unless left open for ventilation. The instructions relative to the sealing of cars and ventilation of perishable commodities must be carefully observed.

901. Trainmen must give proper attention to the handling of livestock, perishable freight, and attendants, and be governed by special instructions relating thereto.

Particular attention must be given to stock unaccompanied by attendants. They must familiarize themselves with and conform to Federal and State Laws governing the handling of livestock.

902. Conductors must see that their cabooses are kept in a clean and neat condition.

903. When necessary to set out bad order cars, a wire report must be promptly made to the superintendent giving initials and car number, nature of defect, and material necessary to repair; if loaded, the report must show contents and waybill reference.

Waybills will be left with agent, or if no agent at point where car is set out, at the first station where there is an agent, with proper endorsement showing why and where car was left.

When cars with any defect are picked up, the same information should be given, and if received from another railroad, this information should be shown.

When repairs are made to foreign cars, a report on prescribed form must be made.

If cars containing valuable equipment or freight liable to be stolen are set out short of destination at a point

where there is no agent, steps must be taken to protect the property.

904. Unless otherwise instructed, all freight handled in trains must be covered by station or card waybills. A car must not be taken from a station if it is unsafely loaded, in which case a report must be promptly made to the superintendent. Waybills must be examined and all instructions thereon complied with. Card bills must be handled with as much care as regular waybills.

905. Unless otherwise directed, when notified that loaded cars are ready for their trains at side tracks which are reached before the billing station for such tracks, the cars may be taken to the billing station where the proper waybills must be procured or the cars left. When the billing station is reached first, the waybills for cars that are expected to be ready to go forward from such side tracks may be taken; but if the cars are found not ready to go, the waybills must be promptly returned by mail to the billing agent with a statement showing why the cars were not taken. The superintendent must also be notified by wire.

906. If there is no agent where freight is left, conductors must check upon the waybill all freight so left, making the proper record on the face of the waybill of all freight, over, short and damaged, and must deliver any freight that is over at such points, to the agent at the billing station for such points.

907. When taking freight from a station where there is no agent, conductors must carefully check the freight, see that it is properly marked and accompanied by a shipping order, and that such orders are delivered to the billing agent for such points, who will furnish the proper billing.

908. Conductors must check all freight loaded by them with the waybills, making the proper record on face of waybill of anything over, short, or damaged.

After unloading they must see that freight left in cars is properly stowed.

909. When freight is transferred from one car to another, full information must be entered on face of the waybill, including the date, and point of transfer, the initials and number of car to which the transfer is made, and over, short, and damaged exceptions.

910. When cars in trains have been pilfered or broken into, conductors will wire the superintendent and railroad police officer from the first available point, giving car number, seal numbers and as much information as practicable.

#### ENGINE MEN.

920. Engine men must report for duty at the appointed time. They must know that their engine is in good working order and is furnished with fuel, water, tools, sand and other supplies, including flagging equipment and signal appliances. They should make every effort to see that the train for which they are called departs on time.

At night, they must have a red light in the cab, where it cannot be seen by passing trains, and when necessary, signal approaching trains.

921. When there is no conductor, or when the conductor is disabled, the engineman will, unless otherwise directed, have charge of the train and will be governed by the rules prescribed for conductors. When more than one engine, the senior engineman in the service will assume these duties.

922. Firemen are subordinate to enginemen. Enginemen must see that firemen are familiar with and perform their duties, instruct them, if necessary, and caution them as to its risks; see that they are conversant with and properly understand and comply with the rules and special instructions, particularly those relating to protection of trains. Disobedience and incompetency must be reported.

The engineman or fireman must not move the engine or any part of its machinery, unless he knows that it can be done without injury to any one. Fireman must not go underneath engine except by advice of the engineman.

923. While switching, the engineman and fireman must both remain on the engine and give close attention to signals. Engine must be handled with great care while making couplings.

The fireman, when competent, may handle the engine under the supervision of the engineman, the engineman being responsible.

When engines under steam are left unattended, the valves must be centered, throttle tightly closed, cylinder cocks opened, and straight air set; and in addition, the wheels must be blocked where conditions require.

924. Care must be used to prevent water being thrown from smoke stack when starting. Cylinder cocks must not be open nor overflow from injector permitted at station platforms, and water must not be wasted from the engine while standing at or passing station platforms during freezing weather.

925. The firing should be done in such a manner as to prevent dense smoke, and the blower used gently to prevent smoke trailing when at stations.

The escape of steam should be prevented when engines are standing at or near stations, road or foot crossings.

Boilers must not be blown out on frogs, switches, interlocking, signal cases, steel bridges, in the vicinity of road crossings, and paralleling a highway when the escaping steam would be liable to obscure the view of the users of the highway, or at any place where it might cause injury to persons or damage to property.

926. Engines must not be coaled while passenger trains are standing or passing on next track. Enginemen must not move engines from fueling stations until

they are sure that employes are off the tender. Water spouts, water cranes, coal chutes, hose or pipe must not be moved to or from the tender while the engine is in motion, and must be empty before they are moved. After being used they must be replaced and secured in proper position.

When using water cranes that are equipped with handles, the spout must be turned from the ground.

927. Engine men and forward brakeman must frequently look back, especially while rounding curves, to observe the condition of the train.

While passing through cities, towns and yards, there must be no failure to keep a careful lookout ahead on both sides of the engine.

928. Fire must be promptly and carefully extinguished at points where ash pans are cleaned and every precaution must be taken to prevent setting fires. Dampers of ash pans must be closed, and grates must not be shaken while passing over bridges or trestles.

Anything that may cause a fire must not be thrown from an engine.

When dumping cinders where there are no pits, the cinders must be leveled off flush with the rail and any fire in them extinguished.

Enginemen must personally inspect and know that the doors of ash pans are closed and properly secured before leaving a terminal or any place where ash pans have been opened. Ash pans and front ends must be cleaned only at cinder pits or designated locations.

929. Any defective condition of the engine must be promptly reported to the master mechanic, and, at the end of each trip a record made on the prescribed form of the repairs required.

930. Engines must not be left standing nearer than 100 feet to a street or highway crossing, or under any bridge, when it can be avoided; nor in the vicinity of waiting rooms, telegraph offices or near cars occupied

by passengers, where the noise or smoke will disturb the occupants.

931. Care must be used to avoid striking stock. When stock is observed inside of right-of-way fence, the train dispatcher must be notified, and if practicable, the section men also. If any livestock is killed or injured, a report must be made on the prescribed form.

932. Care must be used when backing to train, or to take or leave cars. The engine must be prepared to stop when approaching switches which are to be thrown, and a lookout maintained for derail switches.

933. If a train makes an improper station stop, it must not be moved until the conductor gives the proper signal to do so. If, after making stop for water or fuel, or other causes, it should be necessary to move the engine, it must not be done while passengers are leaving or entering the train.

934. While engine is moving, the fireman must keep a constant lookout when not engaged in other duties. He must be on the lookout if the engineman is obliged to look away from the track ahead; he must give instant notice to the engineman of any signals or indication of danger or obstruction, or if there is any reason to believe the train has struck any person or object on the track. He must keep a sharp lookout for signals displayed by other trains, and keep in mind all train orders and notices affecting the movement of trains so as to be prepared to call attention to, or take necessary action in the event of any oversight or mistake.

#### STATION AGENTS.

950. Agents have charge of employes at stations, and must see that they properly perform their duties and are courteous and considerate in their dealings with the public.

They must not be absent from their stations, grant leave of absence to their subordinates, or make any

change in their forces without permission. They are responsible for the railroad's property and other property intrusted to the railroad in the transaction of its business. They must not permit unauthorized persons to frequent offices.

951. The position of main track switches must be observed and the switches must be kept closed and locked in proper position when not in use by trains.

They must see that stations are furnished with necessary signal equipment, and ready for immediate use.

952. Agents must see that the buildings and grounds connected therewith are kept neat and clean and in proper condition for the accommodation of passengers and the handling of freight.

953. Agents must make frequent inspections of yards, platforms, offices, buildings and surroundings; see that the station platforms and walks are properly cleared of snow, ice, or dirt; that rubbish is not allowed to accumulate about any of the buildings, and that the premises are maintained in neat condition.

954. Agents must acquaint themselves with the business interests of the people among whom they are situated, use all proper means to secure traffic and act with the view of accommodating the public, and promoting the best interests of the railroad, notifying the proper officer of anything affecting their department, detrimental thereto or conducive to its good, present or prospective.

955. Agents shall report promptly any information of possible action by State, County, Township, Municipal or other authority, corporation or individual, coming to their notice which will in any way affect the railroad.

956. All cases of attempted robbery, theft of property belonging to or in charge of the railroad, damage to property by fire or storm, personal injury and other extraordinary occurrences at or in the vicinity of the station, must be promptly reported by wire to the superintendent.

957. Notices to the public must be neatly posted in conspicuous places in the station; other advertising matter must not be posted on the premises, except when properly authorized, and then only at places designated for that purpose. Train bulletin boards must bear current date and such information regarding trains as is required by law.

958. Agents must familiarize themselves with the boundaries of the railroad property at their stations, and must not permit any encroachment thereon.

Unless provided for by lease, they must not allow any commodities to be placed on grounds or right-of-way at their stations for the purpose of storage without written permission from the superintendent, and then only after release on prescribed form has been executed by the owner.

959. Agents must preserve order in and about the station, and indicate the places where vehicles shall be allowed to stand at the station, and where the persons in charge thereof, hotel runners and other solicitors shall remain while engaged in their duties on the railroad premises. Bicycle riding on station platforms must not be permitted.

960. When their duties are in any way connected with the handling of United States Mail, agents must be familiar with and be governed by the instructions relative to the transportation and handling of United States Mail.

961. Agents must give prompt attention to correspondence; keep the books and accounts promptly and neatly written up, in the manner prescribed by the accounting and other departments to which they relate, and submit them to the traveling auditor or other authorized officer for examination as may be required. Tariffs must be properly filed.

962. Agents must not permit billboards to be erected nor material placed in such position as to prevent a

plain view of approaching trains; see that cars are not left where they will obstruct view of the main track and that their brakes are securely set; when on a grade, or if the brakes are defective, the wheels must be securely blocked. When there are indications of heavy winds, they must see at once that cars are secured.

963. When unloading of cars is delayed by refusal of consignees to accept freight, or from any other cause, agents must report the matter to the proper officer and obtain disposition therefor. Immediately upon arrival of cars containing railroad material, the consignee should be notified, and if not released within twenty-four hours, the superintendent must be notified.

964. Agents must furnish conductors a switch list; make every effort to avoid delay in the movement of cars, both loaded and empty, and see that they are promptly forwarded.

965. When cars are left short of destination, a wire report must be made to the superintendent advising of their contents, destination and why left; the date and train in which such cars are forwarded must also be reported. Prompt report must be made of the completion of repairs to disabled cars.

966. Every precaution must be taken to prevent fires; stoves, stove pipes and flues must be in safe condition and safeguards taken against fires from loose matches, oily waste or other inflammable materials.

967. Agents must see that all freight loaded is safely and properly stowed, and when necessary is securely fastened by braces, blocks, cleats, stakes, chains, or other means, as the nature of the freight may require to prevent loss or damage by falling, shifting, chafing, breaking, or by contact with any contaminating substance. They must not allow anything to be loaded on the roof of a car.

968. The required cards must be applied to cars as



indicated by the special instructions relating thereto and all old cards, except home route and M. C. B. defect or repair cards must be removed before cars are forwarded.

969. Local freight to be loaded or unloaded must be checked by the conductor and agent together and anything irregular noted on the waybill.

All freight which requires shelter must be promptly placed in freight house or in cars.

970. Freight houses must be locked, and cars containing freight, which can be closed, must be sealed or locked at all times, except when the agent or other authorized person is in immediate charge thereof. Seals must be kept in a secure place and the required seal records made.

971. Freight, baggage, or express must not be left between main tracks, nor within six feet of the edge of main track platforms.

972. Skids, trucks and scales, when not in use, should be placed in baggage room or warehouse; if necessary to leave them on platforms, they should be lined up at the end or in the rear of station building, and must be locked or otherwise secured, with the handles fastened in a nearly vertical position.

973. Agents must not permit women, children or persons incompetent to take care of livestock or other freight, to act as attendants.

#### OPERATORS.

980. Operators must give preferred attention to train order service. They must assist in clerical or other station service when called upon, but must be within hearing of their instruments when possible.

In telegraph offices where several operators are on duty at the same time, only one operator on each shift will be permitted to handle train orders and clear trains.

981. Operators must not permit unauthorized persons to frequent their offices; must not make public the fact

or particulars of accidents, or communicate them to any person, except to the proper officers of the railroad. Messages of a personal nature must be held strictly confidential, and in no manner be made known to any person, except the one addressed; nor be made the subject of remark. Messages for persons on trains must be enclosed in envelopes and sealed.

982. Operators must advise the train dispatcher promptly of fogs and as to severity of all storms and extent of damage. When there are indications of heavy winds, cloudbursts, or abnormal weather conditions, they must see at once that cars at their stations are so secured that they will not move. They must have the necessary signal equipment, and ready for immediate use.

983. Operators going off duty must make a written transfer on the prescribed form, of all train orders, instructions, unfinished business, condition of wires, position of train order signal and overdue trains. The operator going on duty must not handle the train order signal or train orders until the transfer has been completed. Each operator will personally sign the transfer. When shifts are not continuous, the transfer will be made in the same manner. These transfers must be sent to the chief dispatcher, daily.

984. At stations not open continuously, the operators must post their addresses on the inside of the cover of the waybill box.

985. Operators will be held responsible for the prompt delivery of messages at their stations. When answers are required, they must make every reasonable effort to obtain them. In case the person to whom the message is addressed cannot be found, they must notify the office at which it originated, without delay.

986. Operators must understand how to test and

patch wires in switchboard, as ordered, and prompt and careful attention must be given this work.

In closing the office for the day or night, the instruments must be cut out.

Switchboards must be examined frequently to see that plugs are in proper place, and tightly set. Care must be taken to keep instruments in proper adjustment at all times. Before opening key, the relay must be adjusted carefully to see that the wire is not in use.

Wires must not be grounded in switchboard except when necessary in case of wire trouble or when ordered by the wire chief.

987. Inflammable articles and rubbish of all kinds, including oilcloth and rubber typewriter covers, must be kept away from switchboard, wires and instruments.

988. Batteries must be kept clean and in good working condition.

989. Before closing the office for any length of time, and upon reopening the office, operators must notify relay office in order to prevent unnecessary delays to telegrams.

990. All messages filed must show filing time and all proper sending notations. Messages telephoned must show date, time, to whom and by whom telephoned.

#### **TRAIN DISPATCHERS.**

1000. Train dispatchers will issue train orders and will transmit and record them as prescribed by the rules. They will make the various records required and comply with the Special Rules and Instructions.

1001. Train dispatchers must report immediately to the chief train dispatcher any irregularity relating to the movement of trains or the handling and execution of train orders.

1002. Train dispatchers must guard against dangerous conditions and unsafe combinations of train orders.

448 the train of the inferior  
time cable direction.

No. 1 will wait for all  
sections of LKB

Remain until it is  
ascertained that  
the train is complete.

yes 3 times.