



SPRINGFIELD TERMINAL  
INDUSTRY SCHEMATICS

*OPERATIONS PLANNING  
DEPARTMENT*

September 20, 1972

## INDEX

ZONE	AREA
Zone 1 (Section 1)	Industries West of Kansas Avenue
Zone 1 (Section 2)	Industries on Clinton Sub
Zone 2 (Section 1)	Industries Between Kansas Avenue and National Avenue
Zone 2 (Section 2)	Industries East of National Avenue
Zone 3	Industries on Old East Belt and Memphis Main
Zone 4	Industries on Ozark Branch
Zone 5	Industries on Phelps Avenue
Zone 6	Industries on Mill Street
Zone 7	Industries on New East Belt
Zone 9	Industries in West Shop Area

SPRINGFIELD TERMINAL

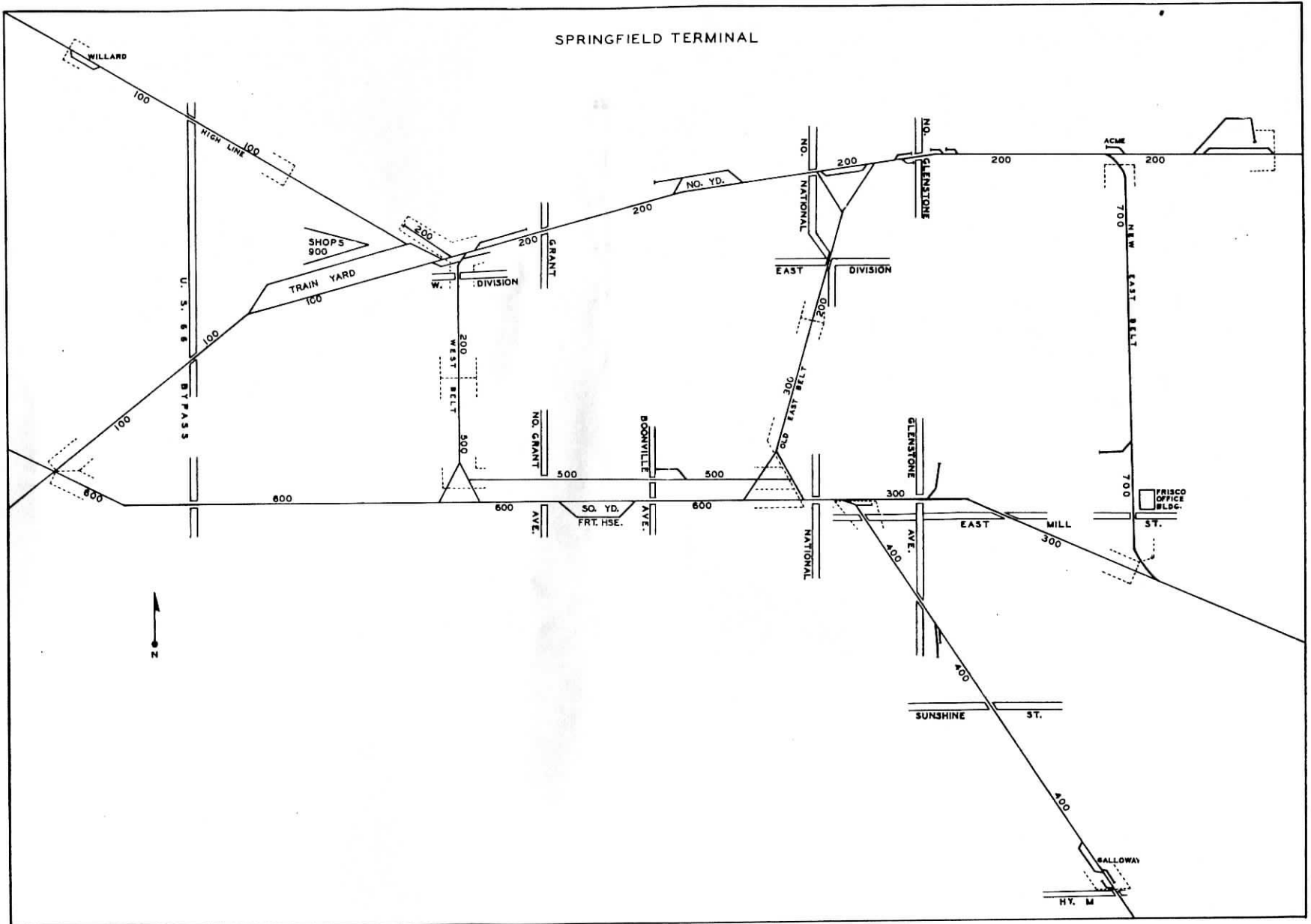

**SPRINGFIELD TERMINAL**

**ZONE 1**

**INDUSTRIES WEST of KANSAS AVENUE**

ZONE 1 INDUSTRIES WEST OF KANSAS AVENUE

- 103 -FRISCO EAST SPEED RIP TRACK
- 105 -STOCK YARD TEAM TRACK
- 105A -SNIDERS IRON & METAL COMPANY
- 105B -FRISCO COMPANY MATERIAL - ROADMASTER DOBBS
- 110 -ROSE-COM PIPE OF SPRINGFIELD INCORPORATED
- 112 -KOSS CONSTRUCTION COMPANY
- 114 -FRISCO WEST SPEED RIP TRACK
- 115 -RALSTON PURINA COMPANY

# SPRINGFIELD YARD

ZONE 1

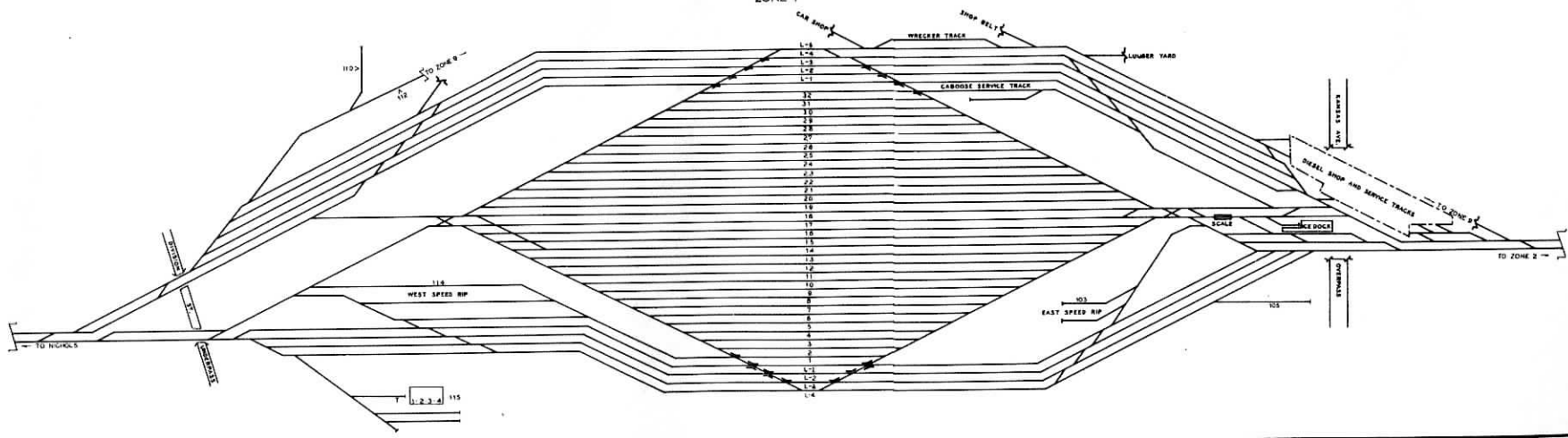

OPERATIONS PLANNING  
REV. 9-77

# SPRINGFIELD TERMINAL

## ZONE 1

INDUSTRIES on CLINTON SUB

ZONE 1 INDUSTRIES ON CLINTON SUB.

- 158 -MASTER BUILDERS - DIVISION MARTIN MARETTA
- 160 -WICKS LUMBER & BUILDING SUPPLIES CENTER
- 161 -SMITH, REX PROPANE COMPANY
- 171 -CONCO QUARRIES INCORPORATED
- 173 -TEAM TRACK - GRAYSTONE
- 175 -MASTERS JACKSON PAVING COMPANY
- 177 -GRAYSTONE QUARRY COMPANY
- 194 -WILLARD BLOCK INCORPORATED
- 196 -TEAM TRACK - WILLARD
- 198 -KILLINGSWORTH FEED MILL



SPRINGFIELD TERMINAL  
ZONE 1 - CLINTON SUB

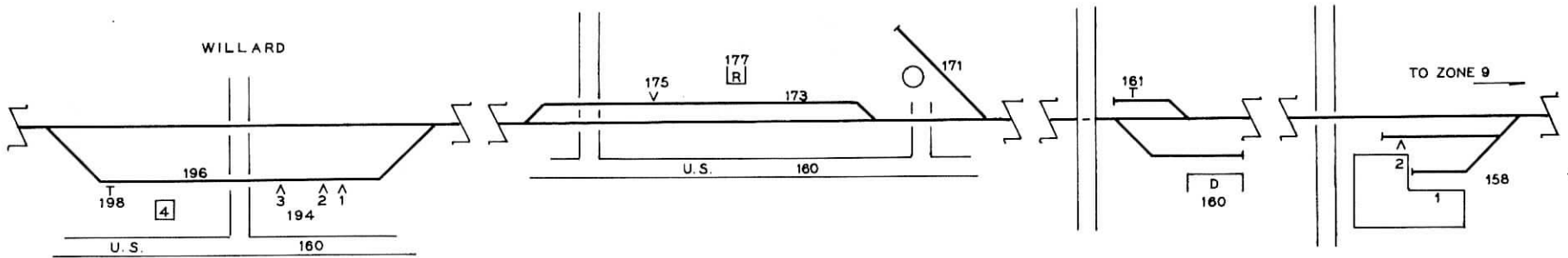

# SPRINGFIELD TERMINAL

## ZONE 2

INDUSTRIES between KANSAS AVENUE and NATIONAL AVENUE

ZONE- 2 INDUSTRIES BETWEEN KANSAS AVENUE AND NATIONAL AVENUE

200	-OZARK HARDWOOD COMPANY	233G	-DR. PEPPER BOTTLING COMPANY
201	-SPRINGFIELD PLYWOODS INCORPORATED	233H	-FRITO-LAY INCORPORATED
202	-LOVE OIL COMPANY	233I	-GIBONEY, CARL ROOFING COMPANY
203	-UNION STOCKYARDS COMPANY	233J	-HASELTINE FRUIT COMPANY
204	-SPRINGFIELD METAL BUILDING COMPANY	233K	-HIGHLAND DAIRY COMPANY
205	-SOUTHERN MISSOURI FREIGHT INCORPORATED	233L	-LOUISBURG FARM SUPPLY
207	-CENTRAL SOYA COMPANY	233M	-MCKINNEYS O.K. MATTRESS COMPANY
208	-SKELLY OIL COMPANY	233N	-MIDWEST SHEET METAL COMPANY
209	-CITY UTILITIES OF SPRINGFIELD - ELECTRIC DEPARTMENT	233O	-NEHI-ROYAL CROWN BOTTLING COMPANY
210	-CITY UTILITIES OF SPRINGFIELD - WATER DEPARTMENT	233Q	-PLEASANT HOPE EXCHANGE
211	-DEGRAFFENREID & SONS INCORPORATED PICKLE COMPANY	233R	-RAILWAY SUPPLY COMPANY
213	-KNIGHT OIL COMPANY	233S	-SPRINGFIELD FELTING COMPANY
214	-ANHEUSER-BUSCH INCORPORATED	233T	-TEXACO INCORPORATED, THE - MT. VERNON, MISSOURI
217	-MCKINNEYS O.K. MATTRESS COMPANY	233U	-TIRE SUPPLY COMPANY
219	-AMERICAN BAG COMPANY	234	-CAMPBELL STREET LUMBER COMPANY
220	-MEEK, C., LUMBER COMPANY NO. 1	235	-JANSS LUMBER COMPANY NO. 2
221	-STANDARD ELECTRIC STEEL CASTING COMPANY	236	-OPEN
222	-NEW LEAD POCKET	237	-JANSS LUMBER COMPANY NO. 1
223	-VIKING SALES	238	-BOLIVAR INSULATION COMPANY - WAREHOUSE
224	-OPEN	239	-FRISCO STORAGE TRACKS - NORTH YARDS
225	-PRODUCERS ICE & MANUFACTURING COMPANY	240	-FRISCO NORTH YARD TRACKS
226	-RHOTEN OIL COMPANY	241	-OPEN
228	-GREEN COUNTY FARMERS SALES ASSOCIATION	242	-FRISCO AUTO DOCK
230	-OPEN	249	-NIXA BOX FRAME COMPANY
231	-SPRINGFIELD WAREHOUSE & TRANSFER COMPANY	250	-OZARK WAREHOUSE GROCERY COMPANY
232	-FRISCO T.O.F.C. RAMPS	251	-FRISCO RIBBON RAIL PLANT
233	-COMMERCIAL STREET TEAM TRACK	252	-PANNEL, TOM LOG COMPANY
233A	-AMERICAN BAKERIES COMPANY	253	-NORTH AMERICAN TIMBERS
233B	-AMERICAN VAN & STORAGE COMPANY	254	-BOLIVAR INSULATION COMPANY
233D	-CAMPBELL STREET LUMBER COMPANY	255	-OPEN
233E	-C & G DISTRIBUTING COMPANY		
233F	-COX FARM SUPPLY		

SPRINGFIELD TERMINAL  
 ZONE 2 - PAGE 1

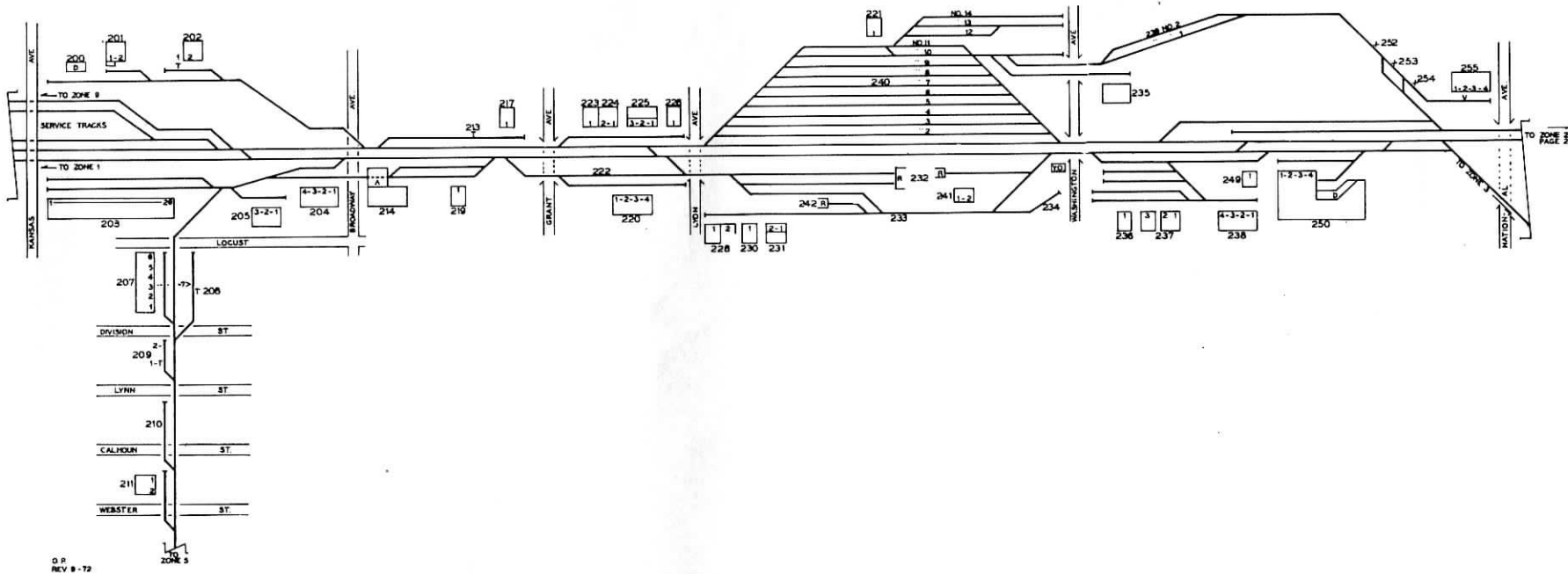

**SPRINGFIELD TERMINAL**

**ZONE 2**

**INDUSTRIES EAST of NATIONAL AVENUE**

ZONE 2 INDUSTRIES EAST OF NATIONAL AVENUE

260 -SPRINGFIELD AVENUE TEAM TRACK  
260A -AMOS MILLWORKS  
260B -SELSOR, GRANT & SONS LUMBER  
261 -ALLIED MANUFACTURING COMPANY  
263 -HUFF EQUIPMENT COMPANY  
263A -PENNZOIL COMPANY  
264 -WOLTERS, BILL WAREHOUSE  
270 -SPRINGFIELD ICE & REFRIGERATION COMPANY  
270A -SELSOR, GRANT & SONS LUMBER COMPANY  
271 -DAILY WOODWORKS INCORPORATED  
272 -MISSOURI STATE HIGHWAY DEPARTMENT  
273 -OPEN  
274 -STEWART-NATTINGER INCORPORATED  
275 -MIDWEST WALNUT COMPANY  
276 -TRAILMOBILE DIVISION OF PULLMAN INCORPORATED  
277 -MONTGOMERY WARD & COMPANY  
278 -TOOMBS & COMPANY  
279 -ROGERS & BALDWIN HARDWARE COMPANY NO. 2  
280 -BRISTOL MANUFACTURING COMPANY  
281 -SOUTHERN MISSOURI CONTAINERS INCORPORATED  
282 -ZENITH RADIO CORPORATION OF MISSOURI  
283 -ZENITH STORAGE TRACK  
284 -ACME STRUCTURAL INCORPORATED  
290 -SECURITY TERMINAL CORPORATION  
291 -GRIESEMER STONE COMPANY  
294 -WALLY TEAM TRACK  
294B -SPRINGFIELD READY MIX -SAND-  
294C -REED, G.W., PAVING COMPANY  
294D -KOSS CONSTRUCTION COMPANY - SAND & CEMENT  
299 -FRENCH, R.T., COMPANY

SPRINGFIELD TERMINAL  
 ZONE 2 - PAGE 2

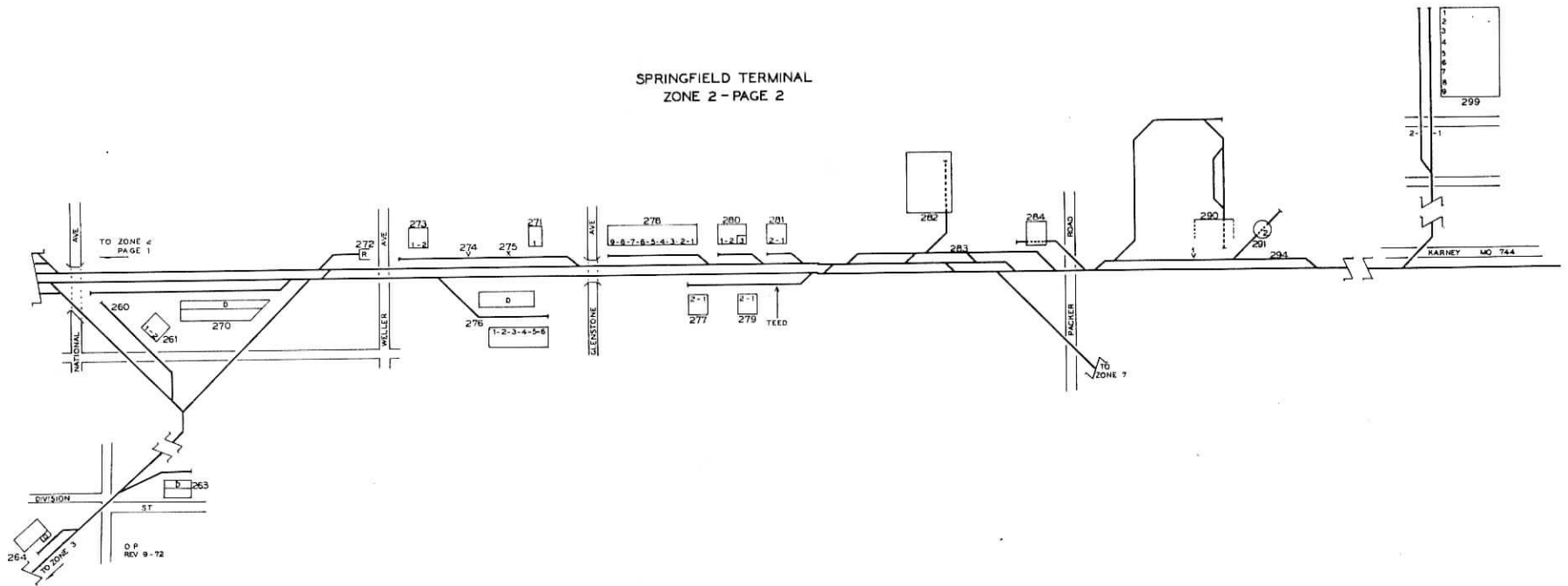

# SPRINGFIELD TERMINAL

## ZONE 3

INDUSTRIES on OLD EAST BELT and MEMPHIS MAIN



ZONE 3 INDUSTRIES ON OLD EAST BELT AND MEMPHIS MAIN

309 -MASTER BUILDERS DIVISION MARTIN MARITTA  
310 -COCA COLA BOTTLING COMPANY  
311 -BRATCHER BAG COMPANY  
312 -VANHOOK, BRYAN M., COMPANY  
313 -TINDLE MILLING COMPANY  
314 -GRACE, L.J., MANUFACTURING COMPANY  
315 -SAFEWAY ROOFERS INCORPORATED  
316 -FAY SUPPLY OF SPRINGFIELD INCORPORATED  
318 -KARCHMER IRON & SUPPLY COMPANY  
319 -MCGREGOR DRY GOODS COMPANY, INCORPORATED  
320 -BIGGS, E.W., & COMPANY  
321 -FRISCO PLANER TRACK  
329 -FRISCO OLD MAIN LINE  
330 -FRISCO TRANSFER TRACK  
331 -COOPER, HARRY SUPPLY COMPANY  
332 -SINCLAIR OIL COMPANY  
334 -MADDEN OIL COMPANY  
335 -COOPER, HARRY SUPPLY COMPANY - PIPE YARD  
336 -CONCRETE COMPANY OF SPRINGFIELD NO. 1  
340 -GENERAL WAREHOUSE CORPORATION  
341 -M.F.A. MILLING COMPANY NO. 2  
342 -OPEN  
345 -INTERCHANGE TRACK - DELIVER TO M.P. RAILROAD  
346 -INTERCHANGE TRACK - RECEIVE FROM M.P. RAILROAD  
350 -STANDARD OIL COMPANY  
351 -OPEN  
352 -REYNOLDS MANUFACTURING COMPANY NO. 1  
355 -FEDEROW IRON & METAL COMPANY  
361 -OPEN  
365 -LILY TULIP DIVISION OF OWENS-ILLINOIS  
370 -M.F.A. PLANT FOODS  
371 -QUEEN CITY OIL COMPANY  
372 -M.F.A. STOCK YARD  
372A -HARKER PAINT & VARNISH COMPANY  
372B -M.F.A. FARM SUPPLY DIVISION  
372C -M.F.A. TIRE DIVISION  
375 -M.F.A. PACKING DIVISION  
379 -CONSUMERS DISCOUNT MARKET  
380 -OPEN

SPRINGFIELD TERMINAL

ZONE 3

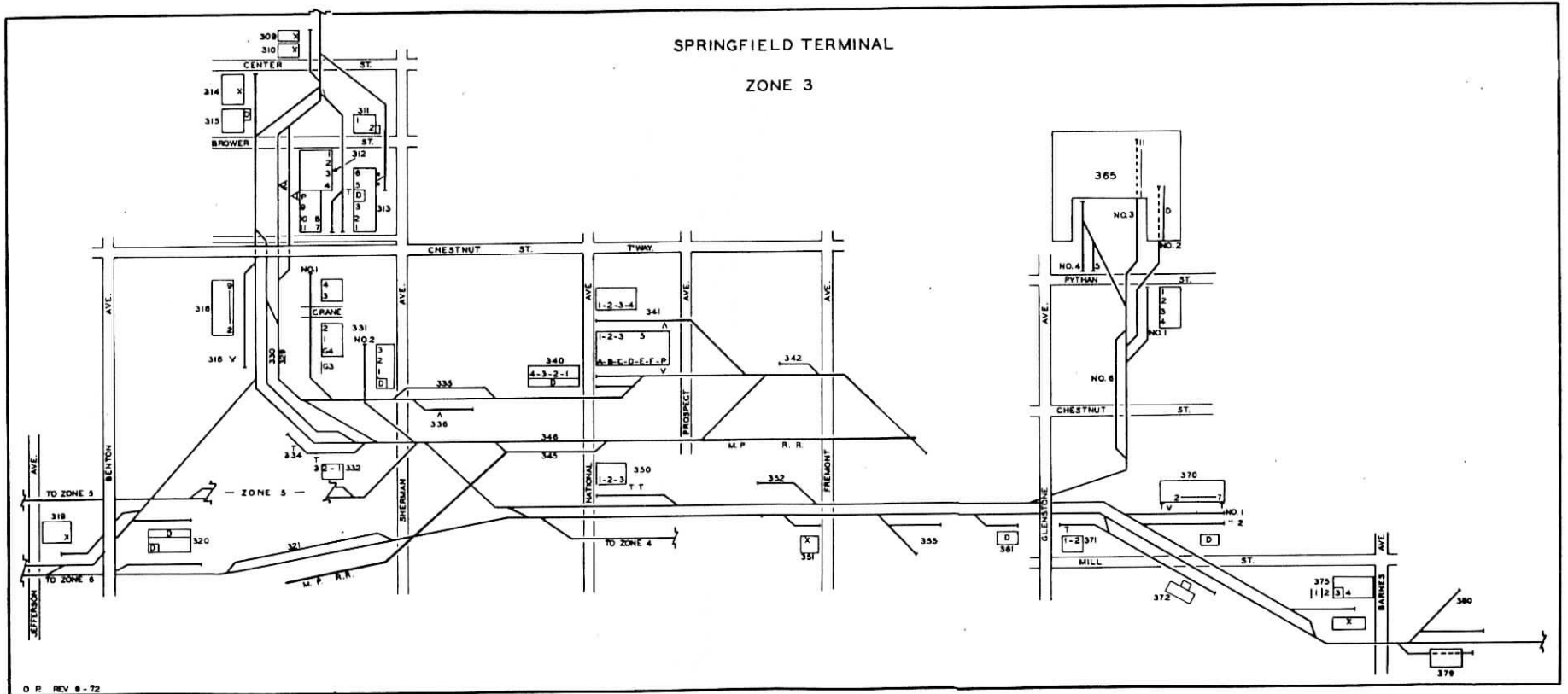

**SPRINGFIELD TERMINAL**

**ZONE 4**

**INDUSTRIES on OZARK BRANCH**

ZONE 4 INDUSTRIES ON OZARK BRANCH

400 -OREILLY AUTOMOTIVE INCORPORATED	423A -ALL WEATHER ROOFING COMPANY
401 -COON ROOFING COMPANY	423C -BRAMER CONSTRUCTION COMPANY
401A -JET LUMBER COMPANY	423D -CRANK DRUG COMPANY
401B -EARNHARDT, E.B., INCORPORATED	423H -GILMORE TRANSFER & STORAGE COMPANY
402 -REYNOLDS MANUFACTURING COMPANY NO. 2	423J -HICKORY HILLS COUNTRY CLUB
403 -COOPERAGE TEAM TRACK	423K -JET LUMBER COMPANY
403A -AMERICAN BAKERIES COMPANY	423M -MARK LINDYS SPRINGFIELD APPLIANCE CENTER
403B -AMOS MILLWORKS	423O -SPRINGFIELD ROOFING COMPANY
403C -JET LUMBER COMPANY	423P -SUPERIOR TILE & LINOLEUM COMPANY
403F -KEITH, EDWARD	424 -CHERRY STREET LUMBER COMPANY NO. 2
403G -LEE, ROBERT E., LUMBER COMPANY	426 -KRAFT FOODS
403H -LIPSCOMB AGRICULTURAL SUPPLY	428 -KRAFT FOODS WHEY PLANT
403I -SEARS ROEBUCK & COMPANY	430 -WOODLAND LUMBER SALES
403J -WILLIAMSON EQUIPMENT COMPANY	435 -WEBSTER HYDRO GAS COMPANY NO. 1
404 -SPRINGFIELD PAPER COMPANY	436 -MAY DISTRIBUTING COMPANY
405 -OPEN	437 -LANGSTON TEAM TRACK
406 -PENTHOUSE FURNITURE LIMITED	437A -BRIDGES & COMPANY
407 -RHODES, PETE SUPPLY COMPANY	437B -FERGUSON STONE MANUFACTURING COMPANY
408 -MCGREGOR VARIETY COMPANY	437G -MARK LINDYS SPRINGFIELD APPLIANCE CENTER
409 -LEE, ROBERT E., LUMBER COMPANY	437I -SELSOR, GRANT & SONS LUMBER COMPANY
410 -LIPSCOMB AGRICULTURAL SUPPLY	438 -CONCRETE COMPANY OF SPRINGFIELD NO. 3
414 -CHERRY STREET LUMBER COMPANY NO. 1	439 -WEBSTER HYDRO GAS COMPANY NO. 2 - TANK CAR SPOT
417 -NORMAL SPUR TEAM TRACK	441 -GENERAL ELECTRIC COMPANY
417B -CHERRY STREET LUMBER COMPANY	470 -ASH GROVE LIME & CEMENT COMPANY
417C -FERGUSON STONE MANUFACTURING COMPANY	471 -GALLOWAY TEAM TRACK
417D -JET LUMBER COMPANY	471A -GALLOWAY SCHOOLS
421 -GLENSTONE BLOCK COMPANY	474 -OZARK GAS & APPLIANCE COMPANY
422 -HERRMAN LUMBER COMPANY	475 -GRAVEN CONCRETE COMPANY - WAREHOUSE
423 -WOODRUFF SPUR TEAM TRACK	476 -GRAVEN CONCRETE COMPANY

SPRINGFIELD TERMINAL

ZONE 4

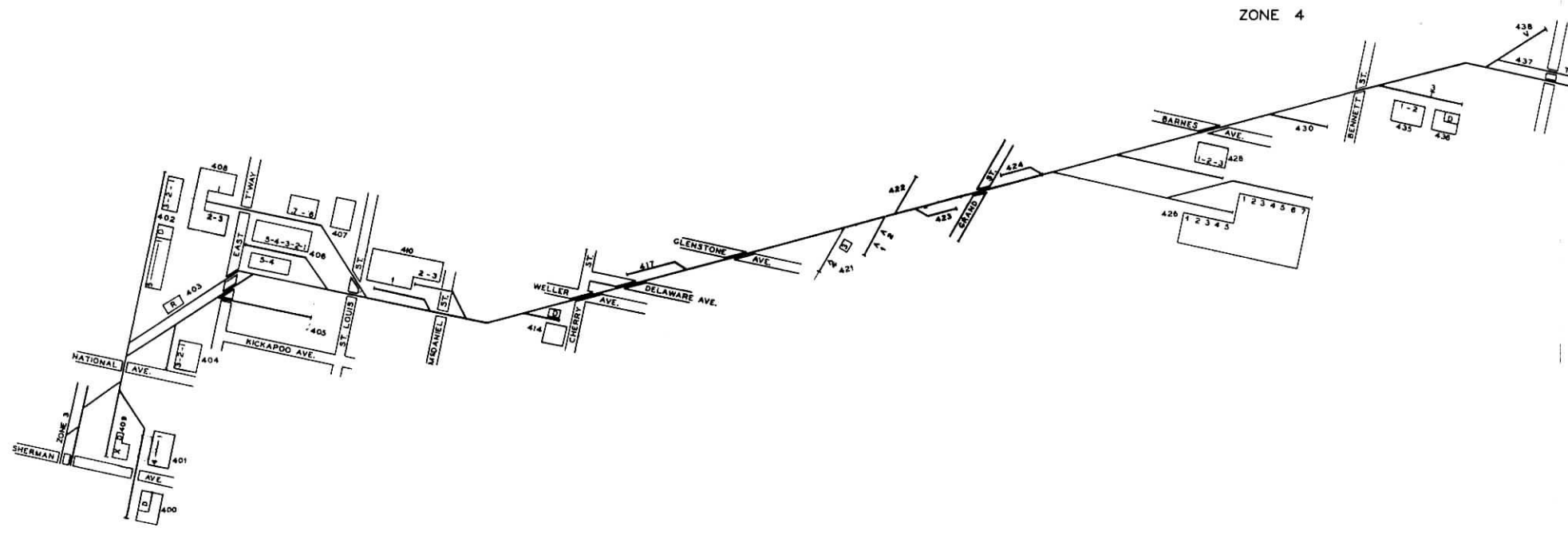

SPRINGFIELD TERMINAL

ZONE 4

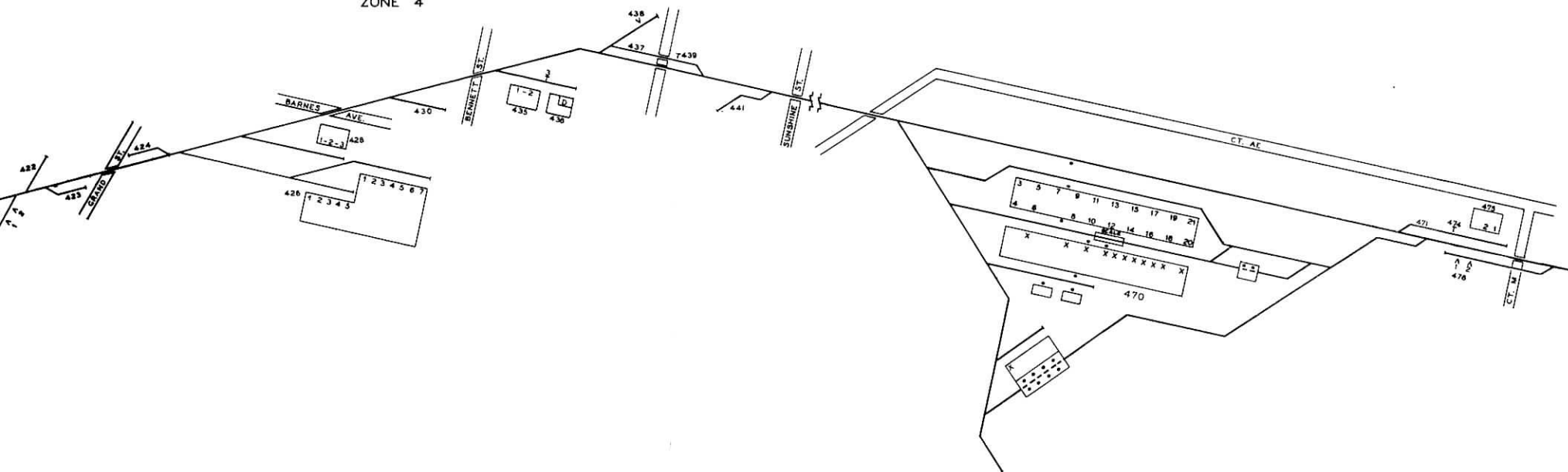

**SPRINGFIELD TERMINAL**

**ZONE 5**

**INDUSTRIES on PHELPS AVENUE**

ZONE 5 INDUSTRIES ON PHELPS AVENUE

500 -FRISCO OLD HOUSE TRACK  
 501 -KENNEDY BRICK & STEEL COMPANY  
 503 -SPRINGFIELD, CITY OF - GRAVEL  
 504 -FERGUSON FLOUR & FEED COMPANY  
 505 -MEEK, C., LUMBER COMPANY NO. 3 - PHELPS AVENUE YARD  
 506 -PHELPS AVENUE TEAM TRACKS  
 506A -INTERNATIONAL HARVESTER SALES CO.  
 506B -INTERNATIONAL HARVESTER CO.  
 506C -OZARK TRACTOR & IMPLEMENT CO.  
 506D -SEDGWICK FURNITURE CO., INC.  
 507 -SOUTHERN MATERIALS COMPANY  
 508 -OZARK MOTOR & SUPPLY COMPANY  
 509 -OUTDOOR RECREATUONAL DISTRIBUTORS  
 511 -UNITED STATES POST OFFICE ANNEX  
 512 -M.F.A. MILLING COMPANY NO. 1  
 513 -MCCALLS FRUIT COMPANY  
 514 -BANTA FRUIT COMPANY NO. 1 - DOCK 8  
 515 -SPRINGFIELD ICE & REFRIGERATION COMPANY  
 516 -NORMAN BUDGET PAK CANDIES INCORPORATED  
 517 -SPRINGFIELD GARMENT MANUFACTURING COMPANY  
 518 -PRODUCERS GROCERY COMPANY  
 519 -GILMORE TRANSFER & STORAGE COMPANY  
 520 -CITY UTILITIES OF SPRINGFIELD - ELECTRIC DEPARTMENT  
 521 -MIDWEST MATERIALS COMPANY  
 522 -BANTA FRUIT COMPANY NO. 2  
 523 -T & S SALES COMPANY - WAREHOUSE  
 524 -CHECKER TRANSFER & STORAGE COMPANY  
 525 -PRODUCERS PRODUCE COMPANY  
 526 -PRODUCERS COLD STORAGE COMPANY  
 527 -LIPSCOMB BROTHERS INCORPORATED  
 529 -MID-AMERICA DAIRYMEN INCORPORATED  
 530 -MID-AMERICA DAIRYMEN INCORPORATED - WAREHOUSE NO. 1  
 531 -MID-AMERICA DAIRYMEN INCORPORATED - WAREHOUSE NO. 3  
 532 -FORESTER CHEMICAL COMPANY  
 533 -OPEN  
 535 -MCKESSON CHEMICAL COMPANY  
 536 -CRESCENT FLOUR & FEED COMPANY  
 538 -MIDWEST FIBRE SALES CORPORATION  
 540 -LEGGETT & PLATT INCORPORATED  
 541 -MIDWEST COMPONENTS SYSTEMS  
 542 -HOUSE OF OBRINE  
 544 -OPEN  
 548 -LEGGETT & PLATT INCORPORATED - WAREHOUSE



# SPRINGFIELD TERMINAL

## ZONE 5

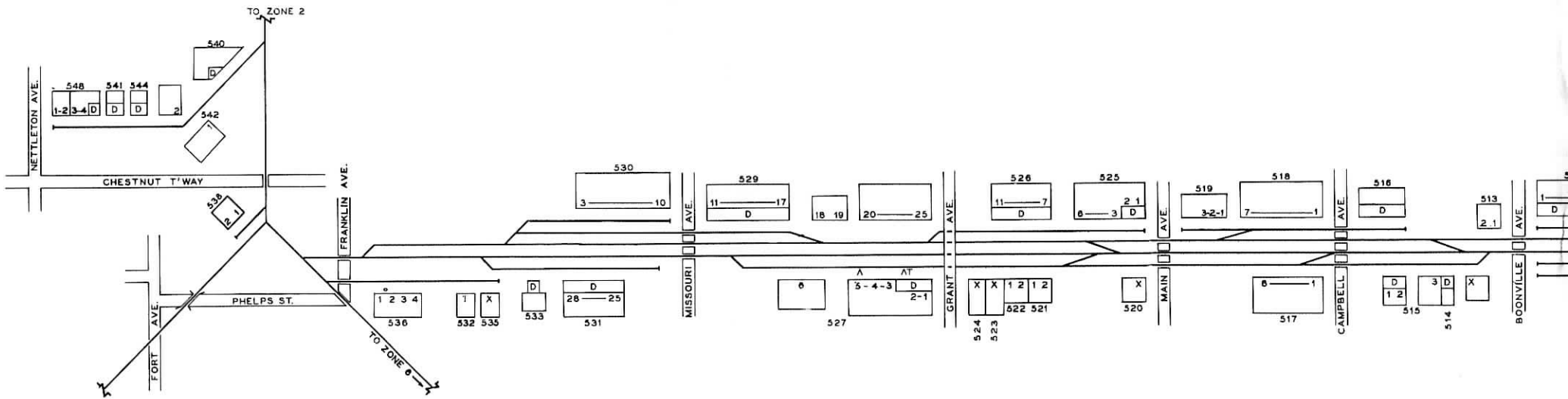

SPRINGFIELD TERMINAL

ZONE 5

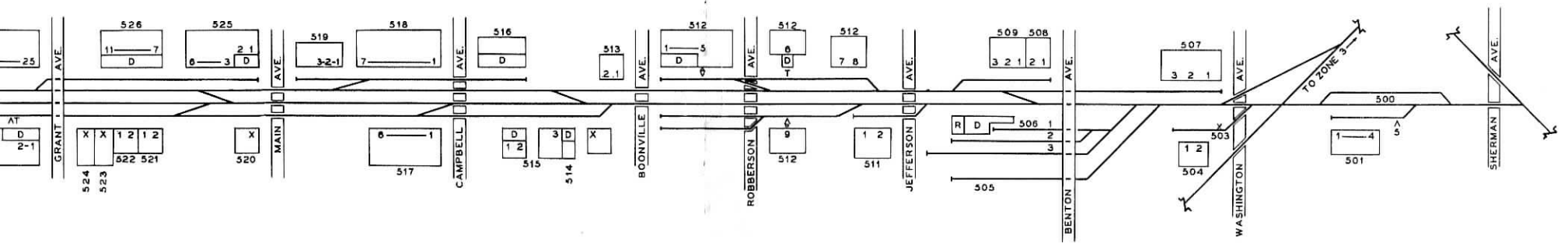

**SPRINGFIELD TERMINAL**

**ZONE 6**

**INDUSTRIES on MILL STREET**

ZONE 6 INDUSTRIES ON MILL STREET

601 -MEEK, C., LUMBER COMPANY NO. 4 - SOUTH YARD  
 602 -MULHOLLAN FURNITURE WAREHOUSE  
 603 -ROGERS & BALDWIN HARDWARE COMPANY NO. 1  
 604 -NATIONWIDE PAPERS INCORPORATED  
 605 -QUINN COFFEE COMPANY  
 608 -SPRINGFIELD GROCER COMPANY NO. 2  
 610 -UNITED STATES POST OFFICE ANNEX  
 611 -SPRINGFIELD GROCER COMPANY NO. 1  
 612 -PIONEER ADVERTISING COMPANY  
 613 -SPRINGFIELD ICE & REFRIGERATION COMPANY - MILL STREET  
 625 -CAMPBELL STREET LUMBER COMPANY  
 626 -SPRINGFIELD ROOFING & CONTRACTING COMPANY  
 629 -CLAREY HOUSE INCORPORATED  
 630 -FINKBINDER TRANSFER & STORAGE COMPANY  
 632 -SPRINGFIELD GARMENT MANUFACTURING COMPANY - MILL STREET  
 633 -GREEN, L.A., SEED COMPANY  
 635 -SPRINGFIELD ICE & REFRIGERATION COMPANY  
 636 -RATHBUN TOBACCO & SUPPLY COMPANY  
 637 -WILLIAMS CHEMICAL COMPANY INCORPORATED  
 640 -SHORT TEAM TRACK NO. 10  
 641 -SHORT TEAM TRACK NO. 11  
 642 -SHORT TEAM TRACK NO. 12  
 642A -BALL PLUMBING COMPANY  
 642B -BARNEYS ROOFING & SIDING COMPANY  
 642D -BRAMER CONSTRUCTION COMPANY  
 642E -CHILES TRACTOR & MACHINERY COMPANY  
 642F -HENNINGSEN FOOD INCORPORATED  
 642G -MADDEN OIL COMPANY  
 642H -OZARK WELDING SUPPLY COMPANY  
 642I -MCCORMICK FARMS  
 642K -PIERCE PIPE & SUPPLY COMPANY  
 642L -SPRINGFIELD WILBERT VAULTS INCORPORATED  
 642M -YOUNG ORCHARD  
 643 -SHORT TEAM TRACK NO. 13  
 643A -AMERICAN BUSINESS MACHINES CO.  
 643D -BARNES GENERAL STORE  
 643E -BARNEYS ROOFING & SIDING CO.  
 643F -BOSSI SALES CO.  
 643H -BRIGHTMAN & SONS, INC.  
 643J -CARNAHAN-WHITE CO.  
 643K -CHILES TRACTOR & MACHY. CO.  
 643K -HOLSUM BREAD CO.  
 643L -C & C FLOOR COVERING, INC.  
 643N -COLONIAL BAKING COMPANY  
 643P -COOK PAINT & VARNISH CO  
 643R -DONDLINGER & SONS CONST.  
 643S -ELKINS & SWYERS PRINTING CO.  
 643U -HARLIN FRUIT CO.  
 643V -HEERS, INC.  
 643W -HERMAN BROWNLOW CO.  
 643Z -INLAND PRINTING CO.  
 643AA-DRENNON, JOHN & SONS  
 643AB-KEITH DISTRIBUTING CO.  
 643AE-LINDYS, MARK SPRINGFIELD APPL. CNTR.  
 643AF-MASSEY FERGUSON CO.  
 643AG-MARTIN BROS.  
 643AH-MAYTAG SALES & SERVICE CO.  
 643AI-MIDWEST LITHOGRAPH & PUBLISHING CO.  
 643AJ-MILLER LUMBER CO.  
 643AM-OZARK MATTRESS CO.  
 643AN-OZARK MOTOR & SUPPLY CO.  
 643AO-OZARK PAPER & JANITOR SUPPLY INC.  
 643AQ-POINDEXTER TILE  
 643AR-PRESS MONTGOMERY MOTOR SALES  
 643AS-PROPHET, GENE MOTOR  
 643AT-RAMEY SUPER MARKETS  
 643AV-ROZELL TRUCK & IMPLEMENT CO  
 643AW-SEDGWICK FURNITURE CO., INC.  
 643AX-SHORTAR -LOCKWOOD-  
 643AY-SOUTHWEST MISSOURI STATE COLLEGE  
 643AZ-SOUTHWEST WHOLESALE CO.  
 643BA-SOUTHWESTERN BELL TELEPHONE CO.  
 643BB-SPRINGFIELD APPLIANCE CENTER  
 643BC-SPRINGFIELD ENGINEERING CO.  
 643BD-SPRINGFIELD MILL & LUMBER  
 643BF-SPRINGFIELD TRACTOR CO  
 643BG-SUPERIOR TILE & LINOLEUM CO.  
 643BH-TURNERS INCORPORATED  
 643BJ-UNITED STATES DEPARTMENT OF AGRICULTURE  
 643BK-UNITED STATES POST OFFICE DEPARTMENT  
 643BN-WESTERN ELECTRIC CO  
 643BO-WHEELER FURN. CO.  
 643CA-BRIDGES & COMPANY  
 644 -FRISCO FREIGHT HOUSE  
 645 -CAMPBELL DISTRIBUTING COMPANY  
 647 -MCGREGOR BROTHERS INCORPORATED  
 648 -FRISCO SOUTH FREIGHT YARD TRACKS  
 660 -FRISCO DIESEL OIL UNLOADING  
 662 -SOUTHERN MISSOURI OIL COMPANY  
 663 -AAA FEED COMPANY  
 664 -JET MATERIALS COMPANY INCORPORATED NO. 2  
 665 -JET MATERIALS COMPANY INCORPORATED NO. 1  
 666 -FRISCO OLD RECLAMATION TRACKS  
 666A -COMPTON-WEST SIDE LUMBER COMPANY  
 666B -UNITED BUILDERS SUPPLY COMPANY  
 667 -SPRINGFIELD READY MIX COMPANY  
 668 -SPRINGFIELD NEWSPAPERS INCORPORATED  
 670 -MUELLER, PAUL COMPANY NO. 1  
 671 -MUELLER, PAUL COMPANY NO. 2  
 690 -MID WEST PLANT FOOD & SUPPLY COMPANY INCORPORATED  
 696 -TEAM TRACK  
 696A -GOLD CROWN EGG COMPANY  
 696B -SPRINGFIELD ASPHALT SEALING COMPANY  
 698 -LIPSCOMB WAREHOUSE

SPRINGFIELD TERMINAL

ZONE 6

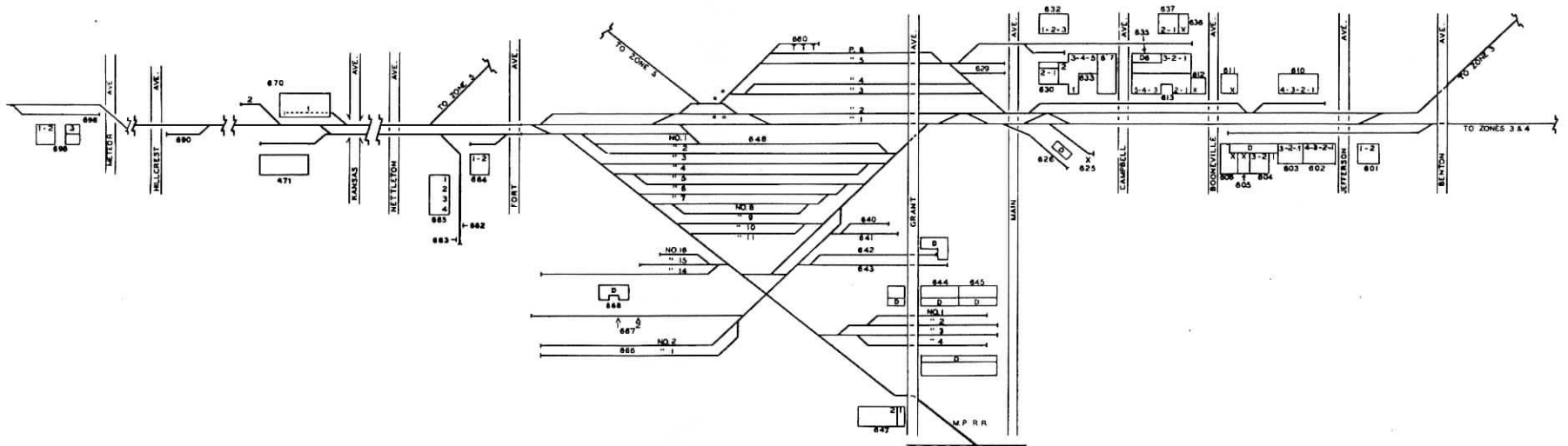

# SPRINGFIELD TERMINAL

## ZONE 7

INDUSTRIES on NEW EAST BELT

ZONE 7 INDUSTRIES ON NEW EAST BELT

710 -FADLER PRODUCE COMPANY  
711 -LYON, FRANK DISTRIBUTING COMPANY  
713 -SPRINGFIELD TABLET MANUFACTURING COMPANY  
714 -SOUTHWEST COOPERATIVE ASSOCIATION  
716 -JOYCE WHOLESALE LUMBER COMPANY  
720 -ACORN METAL PRODUCTS  
721 -SPRINGFIELD WINE & SPIRITS COMPANY  
726 -ALTON BOX BOARD COMPANY  
727 -MCKESSON LIQUOR COMPANY  
733 -U.S. PLYWOOD CORPORATION  
734 -SUTHERLAND LUMBER COMPANY  
741 -GEORGA PACIFIC CORPORATION  
750 -MINNESOTA MINING & MANUFACTURING COMPANY  
763 -SOUTHERN SUPPLY COMPANY  
765 -ASSOCIATED WHOLESALE GROCER COMPANY

SPRINGFIELD TERMINAL  
ZONE 7

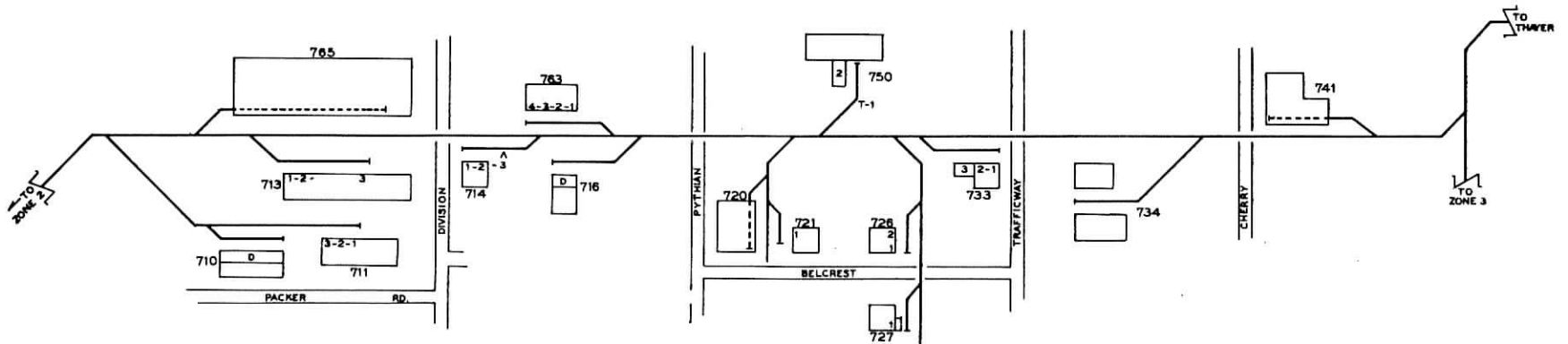

O.P. REV. 9-72



# SPRINGFIELD TERMINAL

## ZONE 9

INDUSTRIES in WEST SHOP AREA

SPRINGFIELD - ZONE 9

WEST SHOPS

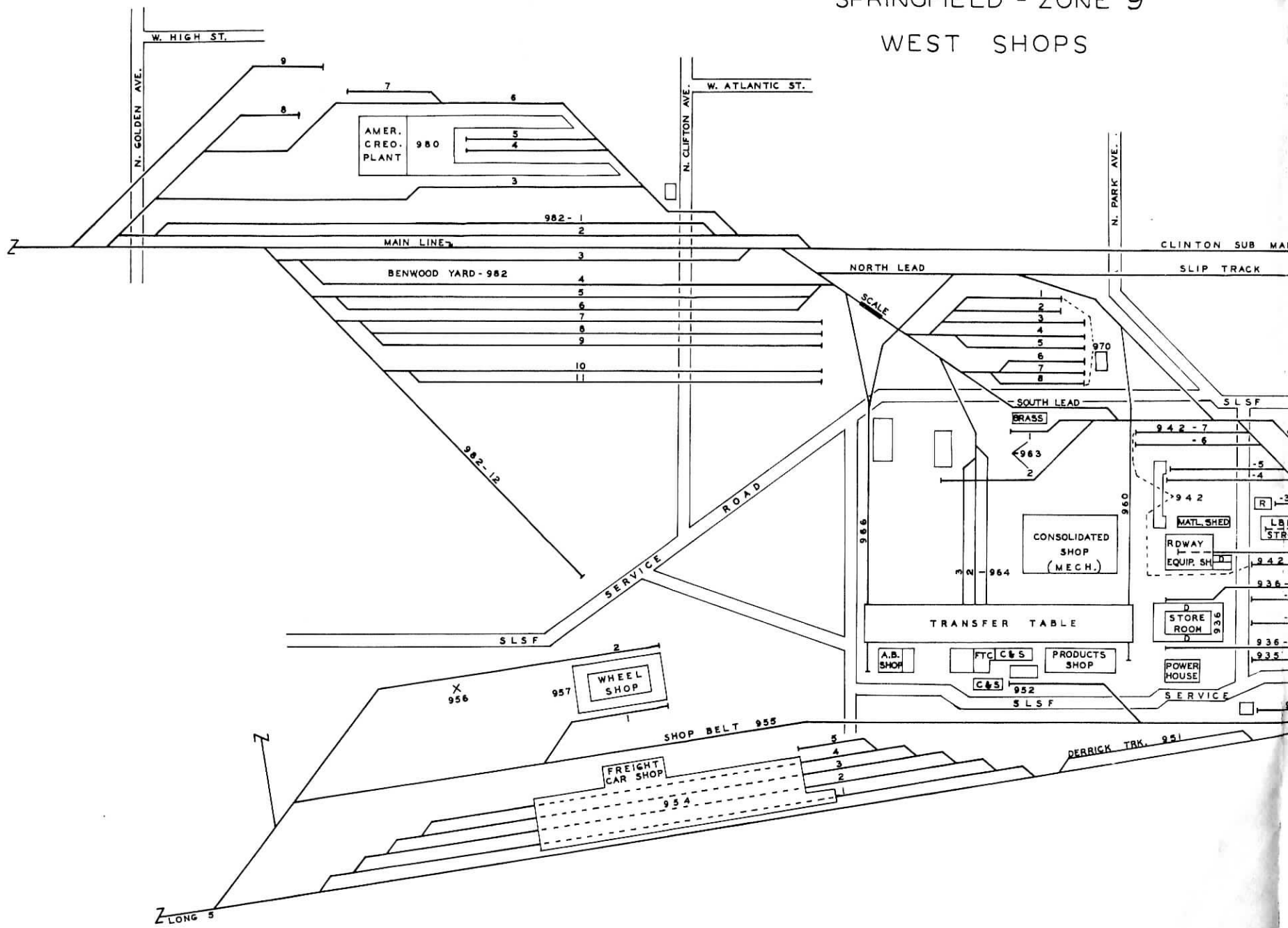

# SPRINGFIELD - ZONE 9 WEST SHOPS

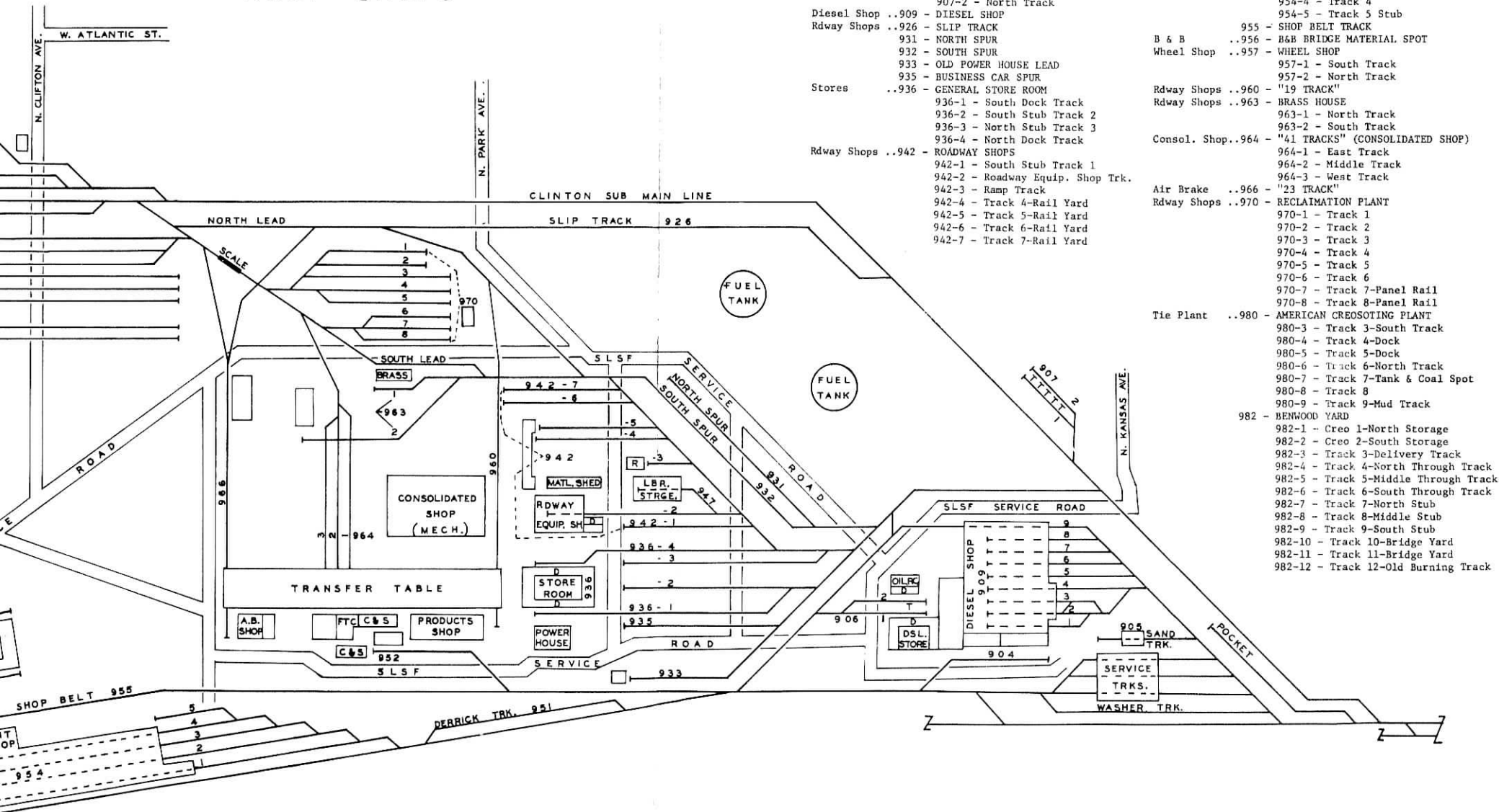

- Diesel Shop ..904 - MONORAIL TRACK
- Diesel Shop ..905 - SAND TRACK
- Stores ..906 - DIESEL STORES
  - 906-1 - Stores Dock
  - 906-2 - Oil Reclamation
- Diesel Shop ..907 - DIESEL OIL UNLOADING
  - 907-1 - South Track
  - 907-2 - North Track
- Diesel Shop ..909 - DIESEL SHOP
- Rdway Shops ..926 - SLIP TRACK
  - 931 - NORTH SPUR
  - 932 - SOUTH SPUR
  - 933 - OLD POWER HOUSE LEAD
  - 935 - BUSINESS CAR SPUR
- Stores ..936 - GENERAL STORE ROOM
  - 936-1 - South Dock Track
  - 936-2 - South Stub Track 2
  - 936-3 - North Stub Track 3
  - 936-4 - North Dock Track
- Rdway Shops ..942 - ROADWAY SHOPS
  - 942-1 - South Stub Track 1
  - 942-2 - Roadway Equip. Shop Trk.
  - 942-3 - Ramp Track
  - 942-4 - Track 4-Rail Yard
  - 942-5 - Track 5-Rail Yard
  - 942-6 - Track 6-Rail Yard
  - 942-7 - Track 7-Rail Yard
- Stores ..947 - MILL TRACK-LUMBER STORAGE
- Car Dept. ..951 - DERRICK TRACK
- C & S ..952 - COMM. & SIGNALS SHOP TRACK
- Car Dept. ..954 - FREIGHT CAR SHOP
  - 954-1 - Track 1
  - 954-2 - Track 2
  - 954-3 - Track 3
  - 954-4 - Track 4
  - 954-5 - Track 5 Stub
- 955 - SHOP BELT TRACK
- B & B ..956 - B&B BRIDGE MATERIAL SPOT
- Wheel Shop ..957 - WHEEL SHOP
  - 957-1 - South Track
  - 957-2 - North Track
- Rdway Shops ..960 - "19 TRACK"
- Rdway Shops ..963 - BRASS HOUSE
  - 963-1 - North Track
  - 963-2 - South Track
- Consol. Shop..964 - "41 TRACKS" (CONSOLIDATED SHOP)
  - 964-1 - East Track
  - 964-2 - Middle Track
  - 964-3 - West Track
- Air Brake ..966 - "23 TRACK"
- Rdway Shops ..970 - RECLAMATION PLANT
  - 970-1 - Track 1
  - 970-2 - Track 2
  - 970-3 - Track 3
  - 970-4 - Track 4
  - 970-5 - Track 5
  - 970-6 - Track 6
  - 970-7 - Track 7-Panel Rail
  - 970-8 - Track 8-Panel Rail
- Tie Plant ..980 - AMERICAN CREOSOTING PLANT
  - 980-3 - Track 3-South Track
  - 980-4 - Track 4-Dock
  - 980-5 - Track 5-Dock
  - 980-6 - Track 6-North Track
  - 980-7 - Track 7-Tank & Coal Spot
  - 980-8 - Track 8
  - 980-9 - Track 9-Mud Track
- 982 - BENWOOD YARD
  - 982-1 - Creo 1-North Storage
  - 982-2 - Creo 2-South Storage
  - 982-3 - Track 3-Delivery Track
  - 982-4 - Track 4-North Through Track
  - 982-5 - Track 5-Middle Through Track
  - 982-6 - Track 6-South Through Track
  - 982-7 - Track 7-North Stub
  - 982-8 - Track 8-Middle Stub
  - 982-9 - Track 9-South Stub
  - 982-10 - Track 10-Bridge Yard
  - 982-11 - Track 11-Bridge Yard
  - 982-12 - Track 12-Old Burning Track